

Measurement Guide

**PIM Master™**

**Passive Intermodulation Analyzer  
with Site Master™ Cable and  
Antenna Analyzer and  
2-Port Option**

**MW82119B**

**Anritsu**

## **Unauthorized Use or Disclosure**

Anritsu Company has prepared the product user documentation for use by Anritsu Company personnel and customers as a guide for the proper installation, operation, and maintenance of Anritsu Company equipment and software programs. The drawings, specifications, and information contained therein are the property of Anritsu Company, and any unauthorized use is prohibited; they shall not be reproduced, copied, or used in whole or in part as the basis for manufacture or sale of the equipment or software programs without the prior written consent of Anritsu Company.

## **Export Management**

The Anritsu products identified herein and their respective manuals may require an Export License or approval by the government of the product country of origin for re-export from your country. Before you export these products or any of their manuals, please contact Anritsu Company to confirm whether or not these items are export-controlled. When disposing of export-controlled items, the products and manuals must be broken or shredded to such a degree that they cannot be unlawfully used for military purposes.

## **Updates**

Updates, if any, can be downloaded from the Anritsu website at:

<http://www.anritsu.com/>

For the latest service and sales contact information in your area, please visit:

<http://www.anritsu.com/contact-us>

# Table of Contents

---

## Chapter 1—General Information

1-1	Introduction . . . . .	1-1
1-2	Product Information, Compliance, and Safety . . . . .	1-1
1-3	Contacting Anritsu . . . . .	1-1
1-4	What is PIM? . . . . .	1-2
1-5	Why Test for PIM? . . . . .	1-3
	Line Sweeping and PIM Testing . . . . .	1-3
	Causes of PIM . . . . .	1-3
	PIM Testing Example . . . . .	1-5
1-6	Recommended PIM Testing Procedure . . . . .	1-6
1-7	Higher Order IM Measurements (Options 194, 600, or 902) . . . . .	1-8
1-8	Test Reports . . . . .	1-11

## Chapter 2—Typical Analyzer Setup

2-1	Introduction . . . . .	2-1
2-2	Turning On the PIM Master for the First Time . . . . .	2-1
2-3	Preparing Passive Intermodulation Measurements (PIM) . . . . .	2-2
	Checking Required Tools and Components . . . . .	2-2
	Setting Up the PIM Master . . . . .	2-3
2-4	Calibrating the PIM Analyzer . . . . .	2-4
	1-Port Calibration . . . . .	2-5
	1-Port Residual PIM Verification . . . . .	2-7
	2-Port Calibration . . . . .	2-8
	2-Port Residual PIM Verification . . . . .	2-11
	Verifying the PIM Test Cable . . . . .	2-13
	Checking for External Interference . . . . .	2-13
	Making PIM Measurements . . . . .	2-14
	Measurement Types . . . . .	2-14
	Adding a Limit Line . . . . .	2-15
2-5	Setting Up Markers . . . . .	2-16
2-6	Saving Measurements . . . . .	2-16
2-7	Menu Map . . . . .	2-17
2-8	Measurements Menu . . . . .	2-18
2-9	Test Submenu Key During Measurement . . . . .	2-19
2-10	Limit Menu . . . . .	2-20
2-11	Calibrate Menu . . . . .	2-21
2-12	Other Calibrations Menu . . . . .	2-22

## Table of Contents (Continued)

---

### Chapter 3—PIM versus Time

3-1	Introduction – PIM versus Time Analyzer . . . . .	3-1
3-2	Trace Mode . . . . .	3-2
3-3	PIM vs. Time Measurement Setup . . . . .	3-3
	Configure the PIM Test . . . . .	3-3
	PIM Summary Table . . . . .	3-6
	Bar Graph of Instantaneous PIM . . . . .	3-7
3-4	Making the Measurement . . . . .	3-9
3-5	Sample of PIM versus Time Measurement . . . . .	3-10
3-6	Measurement with Pass Indicator . . . . .	3-11
3-7	Menu Map . . . . .	3-12
3-8	Frequency (Freq) Menu . . . . .	3-13
3-9	Amplitude Menu . . . . .	3-14
3-10	Setup Menu . . . . .	3-15
3-11	Marker Menu . . . . .	3-16

### Chapter 4—Noise Floor Measurements

4-1	Introduction . . . . .	4-1
4-2	Noise Floor Measurement Setup . . . . .	4-2
4-3	Performing the Noise Floor Test . . . . .	4-2
4-4	Noise Floor Time View Measurements . . . . .	4-3
	Noise Floor Measurement with No External Interference . . . . .	4-3
	External Interference Example . . . . .	4-4
4-5	Noise Floor Spectrum View Measurement . . . . .	4-5
4-6	Saving a Noise Floor Measurement . . . . .	4-5
4-7	Noise Floor Menu . . . . .	4-6

### Chapter 5—Distance-to-PIM (DTP)

5-1	Introduction – Distance-to-PIM (DTP) Analyzer . . . . .	5-1
5-2	DTP Measurement . . . . .	5-2
	F1 and F2 Carrier Sources . . . . .	5-2
	Dmax and Data Points . . . . .	5-2
	DTP Parameter Settings . . . . .	5-2
5-3	Post-Calibration Measurement . . . . .	5-3
5-4	DTP Measurement Setup . . . . .	5-4
5-5	Making a DTP Measurement . . . . .	5-7

## Table of Contents (Continued)

---

5-6	Trace Overlay . . . . .	5-8
	DTP/DTP Overlay . . . . .	5-8
	DTP/DTF Overlay (Manual Method) . . . . .	5-9
	DTP/DTF Overlay (Automatic Method) . . . . .	5-10
	Overlay Using Line Sweep Tools Software . . . . .	5-11
5-7	Enhanced Resolution . . . . .	5-12
5-8	Menu Map 1 . . . . .	5-14
5-9	Menu Map 2 . . . . .	5-15
5-10	Distance Menu . . . . .	5-16
5-11	DTP Aid Menu . . . . .	5-18
5-12	DTP Setup Menu . . . . .	5-19
5-13	Cable List Menu . . . . .	5-20
	Confirmation Clear All Favorites . . . . .	5-21
	Cable List. . . . .	5-21
	Favorites (in Cable List). . . . .	5-22
5-14	Windowing Menu . . . . .	5-23
5-15	DTP Amplitude Menu . . . . .	5-24
5-16	Setup Menu . . . . .	5-25
5-17	Units Menu . . . . .	5-26
5-18	Measurements Menu . . . . .	5-26
5-19	Marker Menu. . . . .	5-27
5-20	Resolution Menu. . . . .	5-28
5-21	Cable Menu . . . . .	5-28
	DTP Parameters Window . . . . .	5-28
5-22	Trace Submenu Key. . . . .	5-29
5-23	Reference (Limit) Menu . . . . .	5-30

### **Chapter 6—Trace**

6-1	Introduction . . . . .	6-1
6-2	DTP/DTP Trace Overlay. . . . .	6-1
6-3	DTP/DTF Trace Overlay. . . . .	6-3
	DTP/DTF Trace Overlay Example. . . . .	6-3
	Automatic DTP/DTF Trace Overlay. . . . .	6-4
6-4	Trace Menu, Distance-to-PIM. . . . .	6-5
	Select Color Choice Box . . . . .	6-6
	Valid Trace . . . . .	6-6
6-5	Trace Menu, Noise Floor - Spectrum View. . . . .	6-6

# Table of Contents (Continued)

---

## Chapter 7—Swept PIM

7-1	Introduction – Swept PIM Analyzer . . . . .	7-1
7-2	Swept PIM Setup . . . . .	7-2
7-3	Configure the Swept PIM Test . . . . .	7-3
7-4	Making the Swept PIM Measurement . . . . .	7-4
7-5	Measurement Example . . . . .	7-5
7-6	Menu Map . . . . .	7-6
7-7	Frequency (Freq) Menu . . . . .	7-7
	Swept PIM Aid Menu . . . . .	7-8
	Swept PIM Parameters Dialog Box . . . . .	7-9
7-8	Amplitude Menu . . . . .	7-10
7-9	Setup Menu . . . . .	7-10
7-10	Marker Menu . . . . .	7-11

## Appendix A—PIM Carrier Bands

A-1	Introduction . . . . .	A-1
A-2	PIM Master Carrier Bands . . . . .	A-1

## Appendix B—Windowing

B-1	Introduction . . . . .	B-1
B-2	Distance-to-PIM (DTP) Windowing Examples . . . . .	B-1
	DTP Rectangular Windowing . . . . .	B-2
	DTP Nominal Side Lobe Windowing . . . . .	B-3
	DTP Low Side Lobe Windowing . . . . .	B-4
	DTP Minimum Side Lobe Windowing . . . . .	B-5

## Index

# Chapter 1 — General Information

## 1-1 Introduction

Anritsu developed the MW82119B PIM Master, with Site Master option, to fully characterize the RF performance of transmission systems with a single test instrument. The PIM Master is able to measure: PIM versus Time, Noise Floor, Distance-to-PIM (DTP), and Swept PIM. When equipped with Option 331, the PIM Master can also perform Return Loss, VSWR, Cable Loss, and Distance-to-Fault (DTF) measurements, similar to a Site Master S331E.

<b>Note</b>	Throughout this guide, screen images are provided as examples. The image and measurement details on your instrument may differ from these examples.
-------------	---

This Measurement Guide describes the operation of the PIM Master MW82119B, battery operated PIM Analyzer for performing PIM measurements. For Cable and Antenna Analyzer measurements enabled by Option 331, please refer to the Cable and Antenna Analyzer Measurement Guide (P/N 10580-00241).

<b>Note</b>	PIM is a measure of system linearity as compared to line sweeping, which is a measure of system impedance. Both tests are critical to validate a cellular system.
-------------	---

## 1-2 Product Information, Compliance, and Safety

Read the Handheld Instruments Product Information, Compliance, and Safety Guide (PN: 10100-00065) for important safety, legal, and regulatory notices before operating the equipment. For additional information and literature covering your product, visit the product page of your instrument on <http://www.anritsu.com/> and select the Library tab.

Not all instrument models offer every option. Please refer to the Technical Data Sheet of your instrument for available options.

## 1-3 Contacting Anritsu

To contact Anritsu, please visit:

<http://www.anritsu.com/contact-us>

From here, you can select the latest sales, service, and support contact information in your country or region, provide feedback, complete a “Talk to Anritsu” form to have your questions answered, or obtain other services offered by Anritsu.

Updated product information can be found on the Anritsu web site:

<http://www.anritsu.com/>

Search for the product model number. The latest documentation is on the product page under the Library tab.

## 1-4 What is PIM?

PIM is a form of intermodulation distortion that occurs in passive components normally thought of as linear, such as filters, combiners, surge protectors, cables, connectors, and antennas. When subject to the high RF powers found in cellular systems, however, these devices can generate spurious signals.

Passive Intermodulation (PIM) shows up as a set of unwanted signals created by the mixing of two or more strong RF signals in a non-linear device, such as from a loose or corroded connector, or in nearby rust. Other names for PIM include the “diode effect” and the “rusty bolt effect”.

Many symptoms that could be indicators of PIM problems include the following:

- Receiver desensitization (raised noise floor)
- Rx Diversity alarms
- Spectral regrowth in the transmitter mask
- Excessive dropped or blocked calls, or both
- Reduced data rates
- Cell site coverage shrinking
- Complaints of interference from neighboring cell site owners

PIM signals in the cell receive band can raise the receive noise floor, increase the bit error rate, and shrink the reception area for cellular communications. PIM can come from junctions; from improperly tightened, damaged, or corroded connectors; from filters, combiners, and surge protectors; and from damaged antennas. Other sources include rusty components, such as mounts and bolts or nearby metal structures.

### Power in dBm and dBc

A measurement reading in dBm is absolute power. A measurement value with units of dBc is relative power.

For example, if you set TX<sub>1</sub> and TX<sub>2</sub> to 43 dBm and get a measurement result of -120 dBm (the measurement result as absolute power), this represents a relative power of -163 dBc. The calculation is as follows:

$$-120 \text{ dBm} - 43 \text{ dBm} = -163 \text{ dBc}$$

[measured power in dBm] minus [transmitted power in dBm]  
equals [relative power in dBc]

The term relative power, in this example, is referring to the original output power setting of 43 dBm. When stated in units of dBc, the received PIM power is relative to (is being compared to) the transmitted power level of one test tone. The difference between the transmitted power (in dBm) and the measured PIM power (in dBm) is the relative power, which is then expressed in units of dBc.

#### Note

The use of dBc units is not applicable to Noise Floor measurements, because the transmitters are not On during this measurement.



## 1-5 Why Test for PIM?

Anritsu has developed the PIM Master to verify and troubleshoot Passive Intermodulation (PIM). The PIM Master generates two high-power tones, usually in the transmit band of interest. It displays and measures the third-order, fifth-order, or seventh-order intermodulation products returning from the DUT to the PIM Master. (The third, fifth, and seventh-order intermodulation products can be measured only if they fall into the range of the receive band.) Using Distance-to-PIM technology, the PIM Master can identify the location of PIM sources both inside the antenna system and beyond.

PIM testing provides a measurement of the overall linearity of the antenna system and the surrounding environment. A formula for determining third-order intermodulation (IM3) frequencies is provided in section [“Intermodulation Distortion” on page 1-5](#).

When more carriers are added to a site and transmit power is increased, the impact of PIM on site performance becomes more severe. A low-traffic site might not exhibit the same performance problems as a busy site.

### Line Sweeping and PIM Testing

Line Sweep testing and PIM testing are very different tests. Both are important and are accurate measures of the ability of the cell site to provide service and to perform optimally.

PIM testing measurements indicate the overall linearity of an antenna feed line, the antenna, and the area illuminated by the transmitted signal. The Line Sweep measurements indicate the overall impedance matching of all of the components in an antenna feed line. Both tests need to be performed in order to ensure the overall quality of a site.

PIM testing requires both low system loss and good return loss (VSWR) to achieve an accurate measurement. If PIM testing is performed prior to line sweep testing, then you may not be aware of the impedance characteristics of the transmission line. High insertion loss attenuates the PIM test signals, which prevents full test power from reaching the specific components that require stringent PIM testing. Poor return loss reflects a percentage of the PIM test signals back into the test set, which causes some signal cancellation that can report a false pass. In other words, poor line sweep performance can lead to a false pass for a PIM test.

By performing the line sweep test prior to PIM testing, you can be confident the insertion loss and return loss data are at acceptable levels. This data in turn ensures that the PIM test signals actually reach all components at the correct signal level, offering the most accurate indicator of true PIM performance. By constructing a system using modern, low-PIM practices, the need to break the transmission system back open will be minimized. If the lines are disassembled again to repair or clean a connector, the line sweep and PIM testing will need to be repeated.

### Causes of PIM

PIM is caused by two or more strong RF signals mixing in a non-linear device. These non-linear devices, or junctions, occur in improperly tightened, damaged, or corroded connectors or in damaged antennas. Rusty components, such as mounts and bolts, are also suspect when hunting for sources of PIM.

PIM can be generated anywhere in the RF path. The RF path includes not only the antenna feed system but also the antenna itself, as well as objects illuminated by the antenna. Because RF currents are strongest inside the coaxial cables and physically close to the antenna radiating aperture, non-linear junctions or materials in these locations are more likely to generate harmful PIM than non-linearities away from these regions.

The following list provides guidelines for preventing PIM at cellular installations:

- Visually inspect RF connectors and RF cables before assembly to remove all metal flakes.
- Verify that RF mating surfaces are clean and free of mechanical damage prior to assembly.
- Wipe mating surfaces with a lint-free wipe, moistened with alcohol to remove dirt and oils.
- Face coaxial cables downward while cutting so that any metal flakes that are produced fall out rather than into the coaxial cable.
- Always use sharp cutting tools when preparing the ends of coaxial cables.
- Use the correct cable preparation tools for the type and size coaxial cable with which you are working.
- Remove any metal burrs from the cut edges of coaxial cables prior to connector attachment.
- Prevent foam dielectric material from getting trapped between metal contacting surfaces.
- Remove all adhesive residue from the mating region of the coaxial cable center conductor.
- Properly align RF connectors prior to assembly in order to prevent damage to mating surfaces.
- Apply the torque that is specified by the manufacturer to all mated pairs of RF connectors.
- Do not over-torque RF connectors because doing so may cause damage to contacting surfaces.
- Prevent excessive vibration and shock to RF components when transporting them to the site.
- Prevent RF components from impacting the tower while hoisting.
- Leave protective caps on RF connectors until you are ready to attach the mating cable.
- Avoid loose metal objects within the half-power beam widths of base station antennas, cable trays, vent pipes, air conditioning units, metal flashing, guy wires, and so forth.

## PIM Testing Example

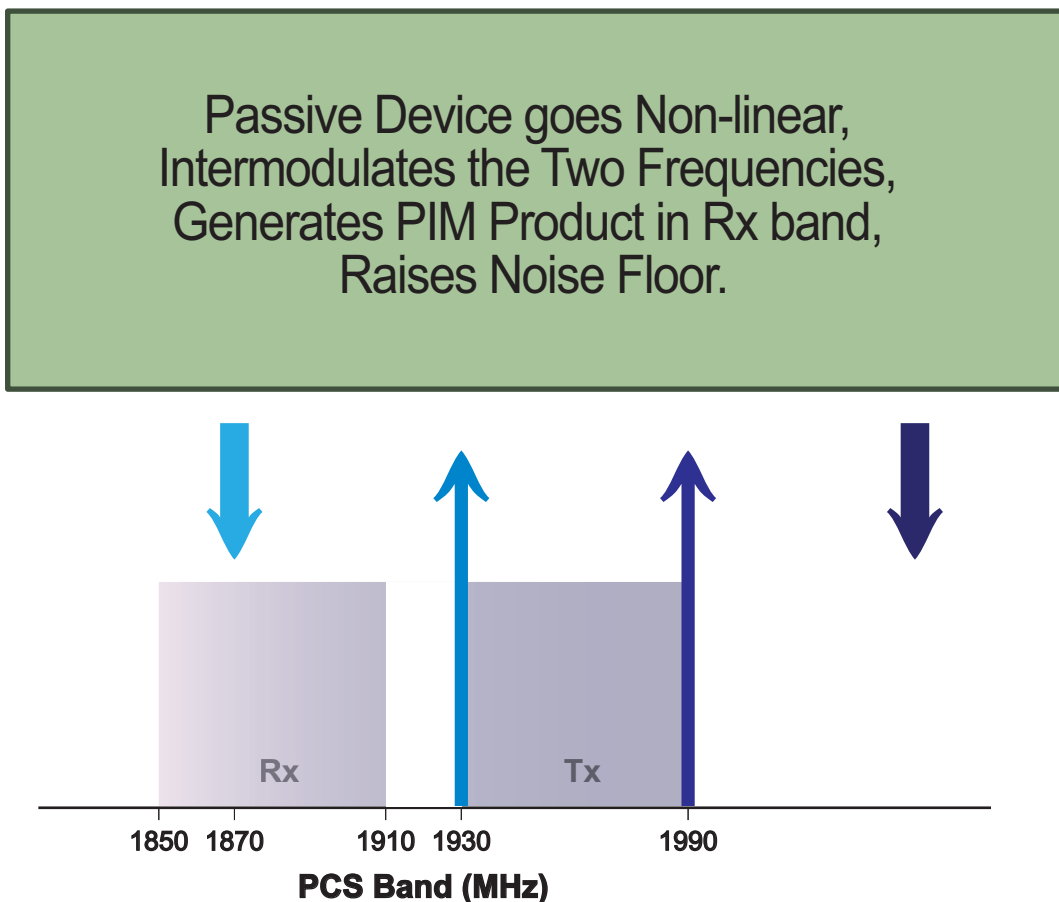

**Figure 1-1.** PCS Band PIM Testing

### Intermodulation Distortion

The intermodulation distortion (IM<sub>x</sub>) is a mathematical function of F<sub>1</sub> and F<sub>2</sub>.

$$\text{3rd Order Intermodulation (IM}_3\text{)} = 2F_1 - F_2 \text{ or } (\text{IM}_3) = 2F_2 - F_1$$

$$\text{2nd Order Intermodulation (IM}_2\text{)} = F_1 + F_2 \text{ or } (\text{IM}_2) = F_1 - F_2$$

### Example of PCS/AWS transmitting

Finding IM<sub>3</sub> when F<sub>1</sub> = 1930 MHz and F<sub>2</sub> = 1990 MHz:

$$\text{IM}_3 = 2F_1 - F_2 = 2(1930) - 1990 = 1870 \text{ MHz (within PCS Rx band)}$$

$$\text{IM}_3 = 2F_2 - F_1 = 2(1990) - 1930 = 2050 \text{ MHz (not within PCS Rx band)}$$

**Example** of 850 MHz band transmitting, and DCS 1800 MHz band Rx between 1710 MHz and 1785 MHz, or AWS Rx between 1710 MHz and 1755 MHz

Finding IM<sub>2</sub> when F<sub>1</sub> = 870 MHz and F<sub>2</sub> = 885 MHz:

$$\text{IM}_2 = F_1 + F_2 = 870 + 885 = 1755 \text{ MHz (within DCS or AWS Rx band)}$$

## 1-6 Recommended PIM Testing Procedure

Before testing for PIM, ensure that line sweeping has been performed so that you can be confident that the insertion loss and return loss data are at acceptable levels. These results ensure that the PIM test signals actually reach all components at the correct signal level, and therefore offer the most accurate indication of true PIM performance.

See [Figure 1-2 on page 1-7](#) for a work flow chart of the recommended site testing procedure.

Typically, a PIM versus Time test is used to certify PIM performance. Anritsu recommends that you perform a Noise Floor measurement before you begin PIM testing. Refer to [Chapter 3, “PIM versus Time”](#) and [Chapter 4, “Noise Floor Measurements”](#) for setup and measurement procedures.

The Noise Floor measurement reveals external signals from mobile subscribers that might interfere with your PIM measurement. If high interference is found, then adjust your F1 or F2 test signals. This will shift the IM3 frequency and may provide you with a clear IM3 frequency for the PIM versus Time measurement. See [Figure 1-1 on page 1-5](#).

After the IM3 frequency has been verified to be clear of interference, perform a PIM versus Time measurement to search for any static PIM sources.

If static PIM sources are found that exceed the pass / fail criteria, then use Distance-to-PIM (DTP) to locate and eliminate these static PIM sources. If DTP identifies multiple PIM sources, then correct the largest magnitude fault and repeat the DTP measurement. Repeat this process until magnitudes of all reported PIM faults appear acceptable.

Return to PIM vs. Time and perform a dynamic PIM test to verify that all RF connections and components are robust. A dynamic PIM test involves lightly tapping on all RF connections and components in the system while measuring PIM versus Time. If the peak PIM observed during the dynamic test is below the customer's pass/fail threshold, then save the measurement.

A PIM Master equipped with Option 331 is able to perform all site PIM tests and Sweep tests using a single instrument.

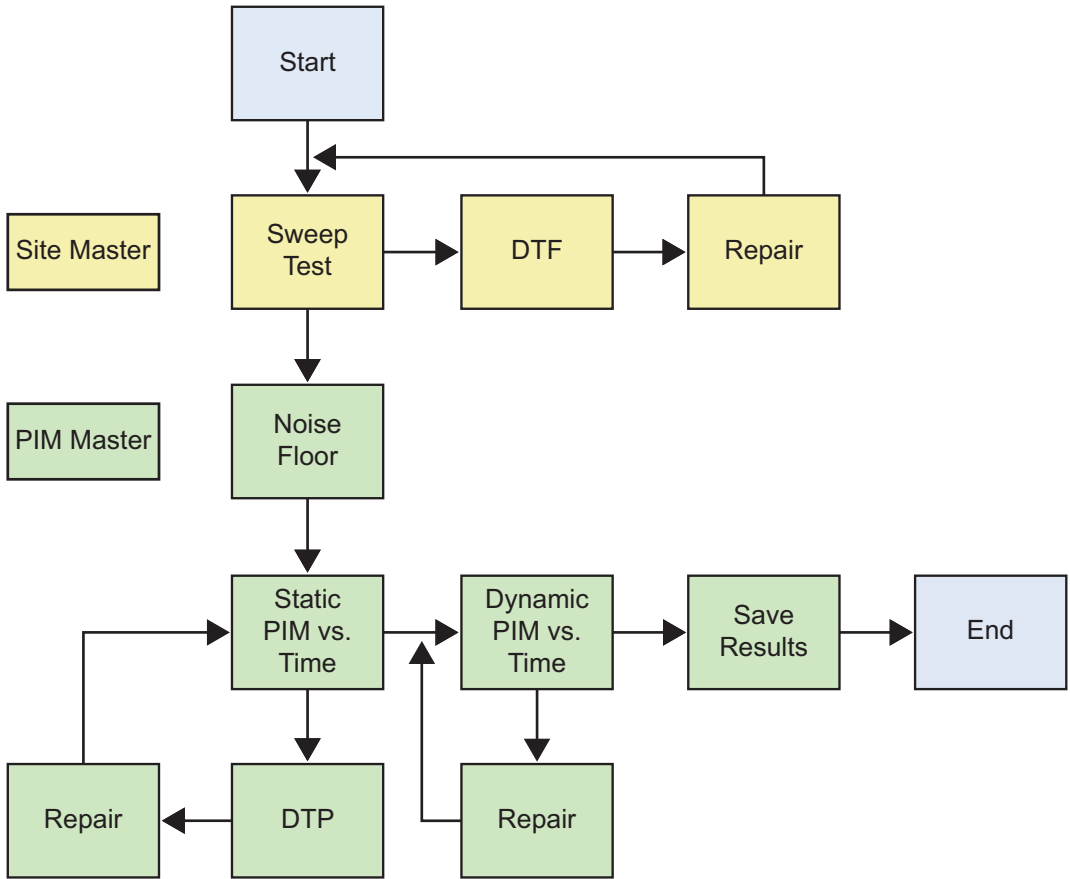
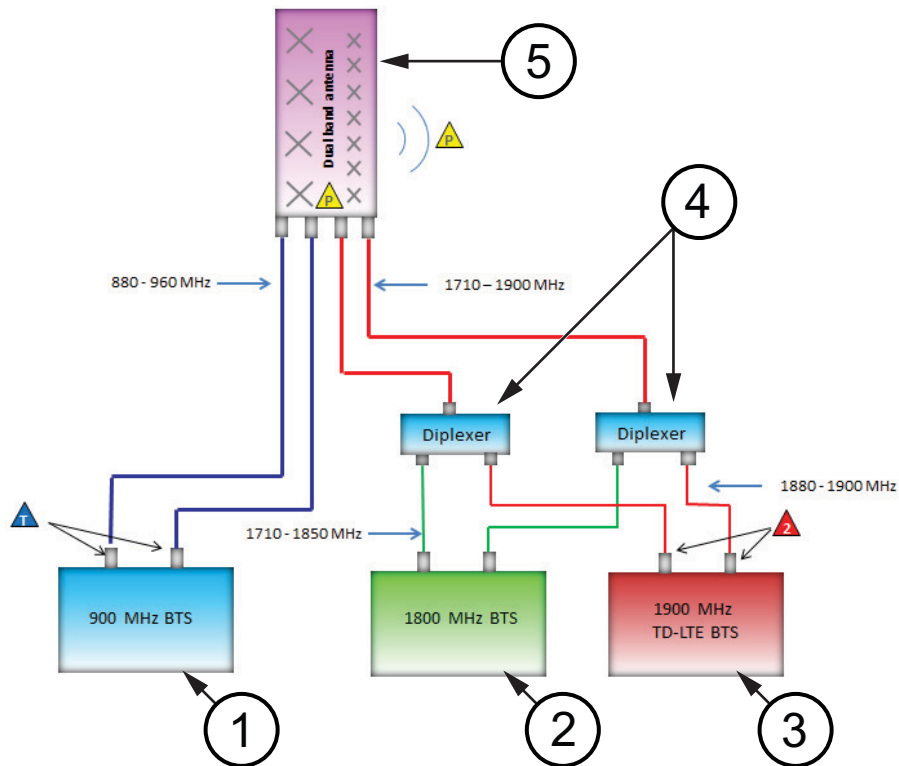

Figure 1-2. Recommended Testing Procedure Work Flow

### 1-7 Higher Order IM Measurements (Options 194, 600, or 902)

When low frequency bands are combined with high frequency bands on a common feed system, higher order intermodulation (IM) products can become a concern. PIM Master Options 194, 600, and 902 were developed to allow direct measurement of these higher order IM products (within the upper band receiver frequency range of the option) created by two transmit tones. The remainder of this section discusses an IM2 measurement with Option 902 using the frequency range of 1877 MHz to 1920 MHz and two 900 MHz transmit tones as an example. The principles apply similarly to the other options.





1.	900 MHz BTS
2.	1800 MHz BTS
3.	1900 MHz TD-LTE BTS
4.	Diplexer
5.	Dual band antenna
	Locations where 900 MHz test tones are injected
	Locations where IM2 can be measured
	PIM Locations that could generate harmful IM2 PIM on the antenna surface PIM beyond the antenna

Figure 1-3. Example PIM Sources and IM2 Products

A typical site where IM2 might be a concern is shown in [Figure 1-3 on page 1-8](#). At this example site, 900 MHz, 1800 MHz, and 1900 MHz signals are sent and received through a dual band sector antenna. The 900 MHz signals are fed to the low frequency band ports of the antenna. The 1800 MHz and 1900 MHz signals are combined and fed to the high frequency band ports of the antenna.



PIM sources in the 900 MHz feed system (blue lines from the 900 MHz BTS in [Figure 1-3](#)) will generate a full array of IM products (IM2, IM3, IM4, IM5, and so forth). Those products that fall within the 900 MHz uplink band will return to the 900 MHz receiver and potentially impact site performance. Those products that fall outside the 900 MHz uplink band (such as IM2) will be blocked by filters inside the 900 MHz BTS receiver and will not impact performance.

These same IM products will couple through the antenna elements and travel down the high frequency band path to the 1800 MHz and 1900 MHz receivers. Before entering the 1800/1900 MHz feed system (red lines from the antenna elements to the diplexers in [Figure 1-3](#)), the IM products will be attenuated by the band-to-band isolation of the antenna. This isolation is typically on the order of 50 dB, meaning that PIM generated in the 900 MHz feed system is attenuated 50 dB before entering the 1800/1900 MHz feed system. This means that IM2 generated in the 900 MHz feed system is unlikely to be at a high enough level to impact 1900 MHz performance.

PIM sources that can be a problem are those on the antenna surface or beyond the antenna that can be illuminated by both the high band and low band radiating elements. These PIM sources are excited by the 900 MHz downlink signals, and generate IM2 signals that radiate directly back into the high frequency band elements. This radiation path is low loss, allowing the IM2 signals to enter the 1900 MHz path at a high level, potentially impacting site performance.

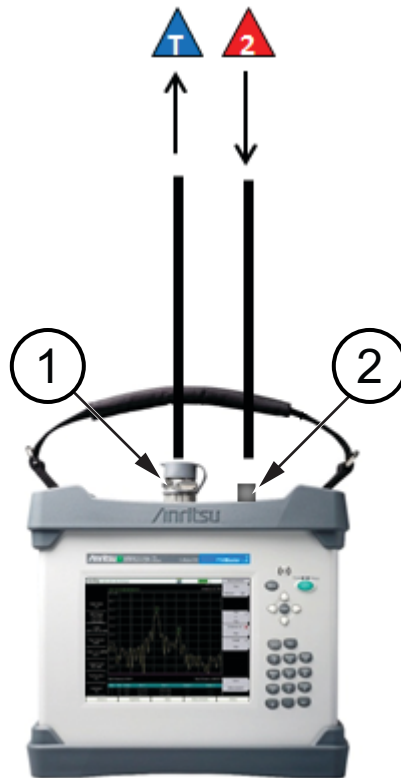
As shown in the site configuration, IM2 that is capable of impacting 1900 MHz performance must be measured on the 1900 MHz path (red lines) while transmitting 900 MHz test tones into the 900 MHz path (blue lines.) The PIM Master supports this measurement by providing two separate test ports on the instrument (see [Figure 1-4 on page 1-10](#)). One test lead connects the **PIM** test port to the 900 MHz feed line, and a second test lead (available with Option 902) connects the **IM2 In** port to the 1900 MHz feed line. While transmitting 900 MHz signals, the PIM Master measures the magnitude of the IM2 products arriving at the 1900 MHz BTS.



1.	PIM test port (900 MHz test tone Tx)
2.	IM2 In test port (Rx only)
	Locations where 900 MHz test tones are injected
	Locations where IM2 can be measured

**Figure 1-4.** PIM Testing for IM2 Products



# 1-8 Test Reports

Use Line Sweep Tools (LST) to view and create reports from saved measurements. Line Sweep Tools can generate a standard report showing plots of the measured results. LST can also generate a special PIM report to display PIM versus TIME or Swept PIM results in a tabular format.

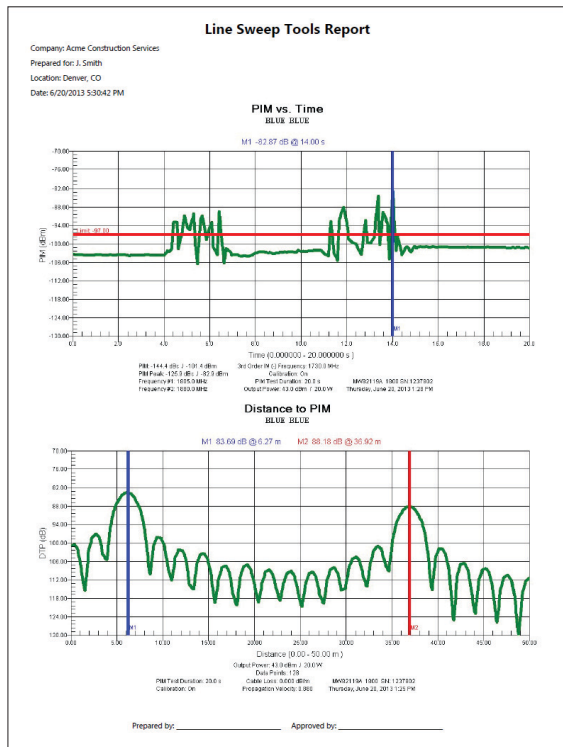

**Passive Intermodulation (PIM) Test Report**  
 ACME CONST SVS

**Site Details**

Site	Operator	Certification
GA3001	John Smith	PM100301

**Test Parameters**

Tone 1 Frequency (MHz)	Tone 2 Frequency (MHz)	IM3 Frequency (MHz)
1930	1990	1870

**Test Results**

Test Point Description	Time	GPS	Power (dBm)	Limit (dBm)	PIM (dBm)	PIM Peak (dBm)	Result
_LOW PIM LOAD	10/16/2013 9:02 PM	N 37°8'49" W 121°39'21"	43.0	-97.0	-132.7	-125.4	Pass
_PIM STANDARD	10/16/2013 9:16 PM	N 37°8'49" W 121°39'21"	43.0	-97.0	-78.7	-78.7	Fail
BLUE BLUE	10/16/2013 9:09 PM	N 37°8'49" W 121°39'21"	43.0	-97.0	-103.9	-100.0	Pass
BLUE BLUE WHITE	10/16/2013 9:09 PM	N 37°8'49" W 121°39'21"	43.0	-97.0	-102.4	-99.0	Pass
BLUE GRAY	10/16/2013 9:10 PM	N 37°8'49" W 121°39'21"	43.0	-97.0	-113.6	-108.7	Pass
BLUE GRAY WHITE	10/16/2013 9:11 PM	N 37°8'49" W 121°39'21"	43.0	-97.0	-115.6	-114.2	Pass
RED BLUE	10/16/2013 9:04 PM	N 37°8'49" W 121°39'21"	43.0	-97.0	-115.8	-114.7	Pass
RED BLUE WHITE	10/16/2013 9:05 PM	N 37°8'49" W 121°39'21"	43.0	-97.0	-105.3	-97.6	Pass
RED GRAY	10/16/2013 9:06 PM	N 37°8'49" W 121°39'21"	43.0	-97.0	-103.8	-97.8	Pass
RED GRAY WHITE	10/16/2013 9:07 PM	N 37°8'49" W 121°39'21"	43.0	-97.0	-117.3	-116.0	Pass

**Anritsu** DOVER WILMINGTON

Test Set Model	Serial Number	Calibration Due	Software Version
MW82119A 1900	1316051	9/20/2014	V1.14

**Anritsu** DOVER WILMINGTON

Page 1

Figure 1-5. Example Report Formats



# Chapter 2 — Typical Analyzer Setup

The Anritsu PIM Master is capable of producing 80 Watts of RF power in the cellular communications bands. Users must take precautions to minimize exposure to these RF fields:

## Warning

Always terminate the PIM output port of the test equipment into a load, a loaded line, or a line that will radiate or absorb the energy before beginning a PIM test.

Confirm that the PIM Master RF power is off after a PIM test.

Always confirm that the PIM RF power is off before disconnecting a coaxial connection, otherwise RF burns may result. Immediate burns to fingers or eyes can result from exposure to live connectors.

Ensure that all antennas under test are placed so that no personnel are exposed to RF levels that exceed the maximum allowable exposure.

## 2-1 Introduction

This chapter describes the basic setup and use of the PIM Master PIM analyzer. Tasks common to all PIM measurements are introduced here. Details for specific PIM measurements are provided in later chapters.

## 2-2 Turning On the PIM Master for the First Time

The Anritsu MW82119B PIM Master is capable of more than 3.0 hours of continuous operation from a fully charged, field-replaceable battery. The PIM Master can also be operated from a 12 VDC source (which will also simultaneously charge the battery). This can be achieved with either the Anritsu AC Adapter or Automotive 12 Volt Adapter. Both items are included as standard accessories (refer to the list of accessories in the Technical Data Sheet for your specific instrument).

## Caution

When using the Automotive Adapter, always verify that the supply is rated for a minimum of 60 Watts at 12 VDC and that the socket is clear of any dirt or debris. If the adapter plug becomes hot to the touch during operation, then discontinue use immediately.

To turn on the MW82119B PIM Master, press the **On/Off** button on the front panel. The PIM Master takes approximately forty seconds to complete power-up and to load the application software. At the completion of this process, the instrument is ready to be used.

## 2-3 Preparing Passive Intermodulation Measurements (PIM)

Along with your PIM Master, you need tools and components that are provided in the accessory kit, and you need to set up the instrument for your planned measurements.

### Checking Required Tools and Components

The following items are supplied with your PIM Master accessory kit or can be ordered separately as individual components. Consult your Technical Data Sheet for part numbers.

- Test cable
- Connector Saver (included with instrument, 7/16 DIN(f) to 7/16 DIN(m), 50  $\Omega$  adapter)

**Note**

The PIM Master ships from the factory with a connector saver pre-attached to the PIM test port connector. Typically, 500 matings is the life of a connector for PIM testing. The connector saver can remain on the PIM Master while inside the soft case or the transit case. Replace the connector saver immediately when residual PIM levels become unacceptable. The recommended torque when replacing the connector is 25 N·m (~18 lbf·ft).

- RF Adapters
- PIM Standard
- Low PIM Load
- Torque Wrenches for various connectors
- Adjustable Wrench
- Cleaning Kit

## Setting Up the PIM Master

1. If necessary, press the **Menu** key and then press the PIM Analyzer icon.
2. Before calibrating the PIM Master, set the parameters for all three measurement types. This will eliminate the need for recalibrating due to changing parameters. To set up the parameters for all three measurement modes, perform the following steps.
3. Press the **Measurements** main menu key and then press the PIM vs. Time submenu key.
4. Press the **Freq** main menu key, then select the input frequencies for the F1 and F2 carriers, and then select the intermodulation order.
  - a. Press the **Carrier F1** submenu key and set the desired frequency.
  - b. Press the **Carrier F2** submenu key and set the desired frequency.
  - c. If necessary, press the **Intermod Order** submenu key until the desired setting is underlined (3rd, 5th, or 7th).
  - d. If necessary, press the **Band Select** submenu key until the desired High or Low setting is underlined (or one of the following with Option 194: PCS or PCS/AWS, Option 600: 1900 MHz or 600 MHz, Option 902: IM2 or GSM).
5. Press the **Setup** main menu key,
6. Set the Output Power level and Test Duration.
7. Press the **Setup** main menu key to set the power level and test duration.
8. Press the **Measurements** main menu key and then press the Distance-to-PIM submenu key.
9. Press the **Setup** main menu key, then the DTP Aid submenu key.
10. On the DTP Parameters screen, use the touch screen to enter or select values for Distance, Data Points, and Cable type (or enter Cable Loss and Propagation Velocity).
11. Visually inspect all RF connectors on the test instrument, test lead, PIM standard, and Low PIM Load. Clean connections each day prior to first use.

**Note**

Save your instrument settings in a setup file to allow easy recall of frequently used settings.

## 2-4 Calibrating the PIM Analyzer

**Caution** During calibration, RF power is present, and the red RF On light is illuminated.

Calibrations are temperature-dependent. A temperature deviation of approximately 20 degrees Celsius voids an existing calibration. Two temperatures are displayed in a white font (in all PIM measurement modes) in the Instrument Settings Summary, just above the Calibration On/Off message. One is the temperature in the PIM Master now, and the other is the temperature in the PIM Master at calibration. When the current temperature (labeled **now**) changes up or down to within 2 degrees of the calibration limit, the font color of the current temperature is displayed in yellow. This color changes to red if the current temperature exceeds the calibration limit. **N/A** is displayed for the calibration temperature when no valid calibration file exists for the current instrument settings.

All calibrations are valid for an initial 12-hour limit. If the PIM Master remains On, and if all settings remain consistent, then the current calibration file remains effective. If any setting is changed after 12 hours, including a power cycle of the PIM Master (Off and On), then a warning is presented indicating that the current calibration is more than 12 hours old. The message instructs the user to verify the instrument residual PIM level and re-calibrate if necessary. Calibrations can be used again after settings are changed and then returned to the previous settings for which the calibration was performed.

The standard calibration calibrates Distance-to-PIM, Swept PIM, PIM vs. TIME, and Noise Floor - Time View for the current instrument settings. A user-defined-calibration dialog is available allowing users to select specific calibrations they wish to perform, and this allows multiple power level calibrations to be performed at the same time (refer to “[Other Calibrations Menu](#)” on page 2-22).

If you are performing a Noise Floor Spectrum View measurement, a separate calibration is required. Press the **Start Cal Spectrum View** button in the **Noise Floor** menu, and then follow the on-screen instructions to calibrate the Spectrum View. (Alternately, you can use the “[User Defined Calibration Dialog Box](#)” on page 2-22.)

**Note** Consult the technical data sheet for part numbers used in calibration.

## 1-Port Calibration

### Procedure

The following steps describe the standard calibration process.

1. Press **Shift** then **Cal (2)**.
2. In the Calibration menu, press the **Start Calibration** submenu key.
3. If conducting a high-band intermodulation measurement (i.e., PCS, 1900 MHz, or IM2), ensure the PIM Master receiver port is open (disconnected) and skip to [Step 4](#). For all other bands, connect the appropriate PIM standard onto the test port of the PIM Master or at the end of the PIM test cable.
4. Connect an appropriate Low PIM Load onto the PIM output port or to the Low PIM standard if used.
5. Press **Enter** to calibrate or **Esc** to exit.
6. If you are conducting a high band intermodulation measurement as noted in [Step 3](#), skip to [Step 13](#). During the calibration, CALIBRATION IN PROCESS... is displayed on the measurement screen in red letters, and a beep is emitted when this step is completed.
7. When prompted, remove the PIM standard and the Low PIM Load and then connect only the Low PIM Load.
8. Press **Enter** to calibrate or **Esc** to exit.
9. If the Low PIM Load is better than  $-88$  dBm, then the calibration continues, as in [Step 10](#). If the Low PIM Load just installed has high PIM, then this calibration will not be useful. If the measured PIM is worse than  $-88$  dBm, then a warning is displayed. See [Figure 2-1 on page 2-6](#). The displayed warning provides 3 options.
  - a. **Verify again** After you have made corrections, press this button to continue the calibration.
  - b. **Bypass verification** Press this button to ignore the warning and continue the calibration.
  - c. **Exit calibration** Press the button to abort the current calibration.
10. During the calibration, CALIBRATION IN PROCESS... is displayed on the measurement screen in red letters, and a beep is emitted when this step is completed.
11. When prompted, remove all components from the test port leaving nothing connected at the point of calibration (Open circuit).
12. Press **Enter** to calibrate or **Esc** to exit.
13. During the calibration, CALIBRATION IN PROCESS... is displayed on the measurement screen in red letters. When calibration is complete, two beeps are emitted, and **Calibration On** is displayed at the bottom of the Instrument Settings Summary.

**Bad Load Detection Feature**

The second part of a calibration requires removal of the PIM Standard and reattachment of the Low PIM Load. If the Low PIM Load has measured PIM worse than  $-88$  dBm, then the **WARNING: High PIM detected** dialog box is displayed (as shown in [Figure 2-1](#)).

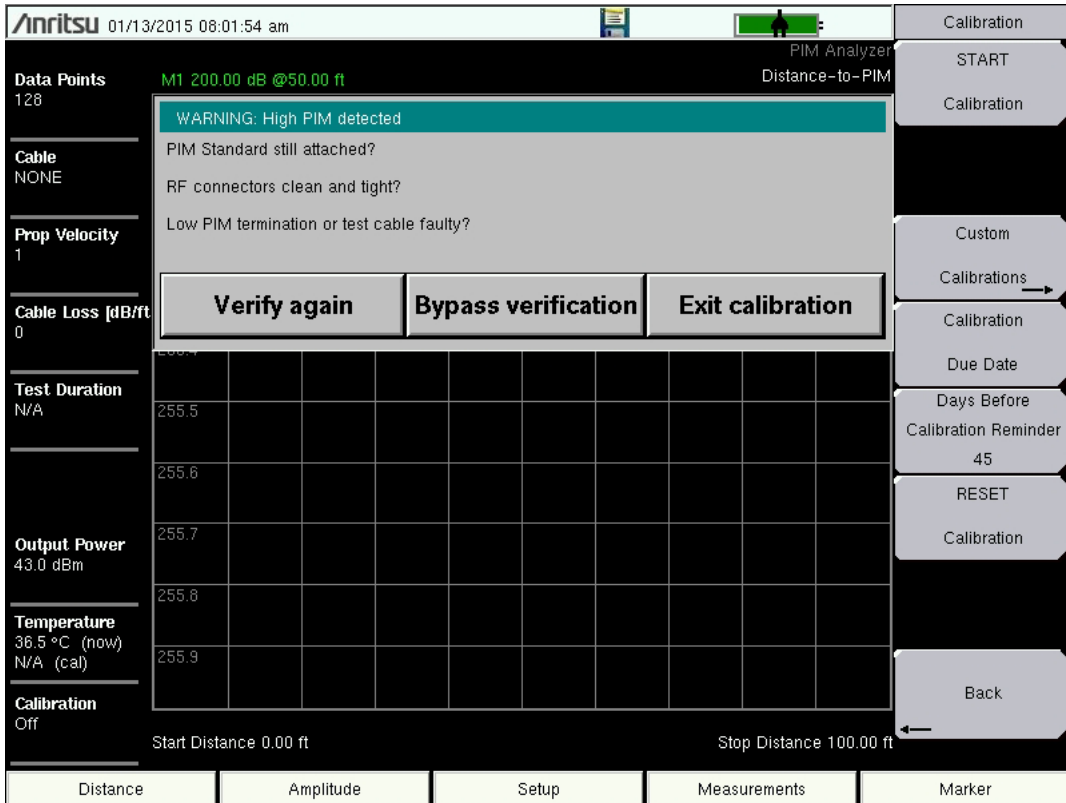

**Figure 2-1.** Bad Load Detection (High PIM) Warning



## 1-Port Residual PIM Verification

For the 2-port residual PIM procedure, see “[2-Port Residual PIM Verification](#)” on page 2-11. Perform this test immediately following a calibration or when instructed to do so, such as when 12 hours or more have elapsed since the existing calibration was performed. Attach the Low PIM Load to the Test Port or to the end of the PIM test cable.

**Note** Confirm that all the connectors are clean of debris or contamination that may cause incorrect PIM measurement results.

### Set to Factory Preset

1. PIM measurement results.
2. Power on the PIM Master.
3. Press the Shift key and then the Mode (9) key.
4. Use the Up/Down arrow keys to highlight PIM Analyzer, and then press the Enter key to switch to PIM Analyzer mode.
5. Press the Shift key and then the Preset (1) key.
6. Press the Preset submenu key to set the instrument to the factory preset state.

### Verify Residual PIM

1. From the Measurements menu, press the PIM vs. Time submenu key.
2. Press the Test submenu key so that Measure is underlined.
3. Lightly tap on the Low PIM Load and flex the PIM test cable (if attached) during the PIM vs. Time test. The peak PIM value should be at least 10 dB below the pass/fail criteria for the DUT.

If the measured PIM is outside of the limit in [Step 3](#), then you may have one of the following problems:

- Metal flakes inside one or more RF connectors
- Loose RF connector
- Faulty Low PIM Load
- Worn connector saver
- Damaged PIM Test Port connector

Investigate and repair the source of any problem, and then repeat the calibration process.

### Verifying the PIM Standard

1. Connect a PIM Standard to the Test Port or to the end of the PIM test cable.
2. Connect a Low PIM Load to the PIM Standard.
3. From the Measurements Menu, press the PIM vs. Time submenu key, followed by the Test submenu key so that Measure is underlined.
4. The peak PIM value for the PIM Standard that you are testing should be within  $\pm 3$  dB of the numbers shown in [Table 2-1 on page 2-12](#). If the measured PIM is outside of the  $\pm 3$  dB limit, contact Anritsu customer service: <http://www.anritsu.com/contact.asp>

## 2-Port Calibration

### Equipment Required

The equipment required for two-port calibration are the PIM Master 700 with option 703, the Port 2 Out to Port 2 Return cable, a PIM standard device.

### Procedure

To perform the standard two-port calibration:

1. Put PIM Master into two-port mode. Select one of these paths:
  - Measurements > PIM vs Time > Frequency > 2-Port Mode
  - Measurements > Distance to PIM > Distance > 2-Port Mode
  - Measurements > Swept PIM > Frequency > 2-Port Mode

**Note** Two-port mode may be entered only when Band Select is set to Low.

2. Press **Shift** then **Cal (2)**.
3. In the Calibration menu, press the **Start Calibration** submenu key.  
The PIM Master displays the to PIM Calibration prompt.

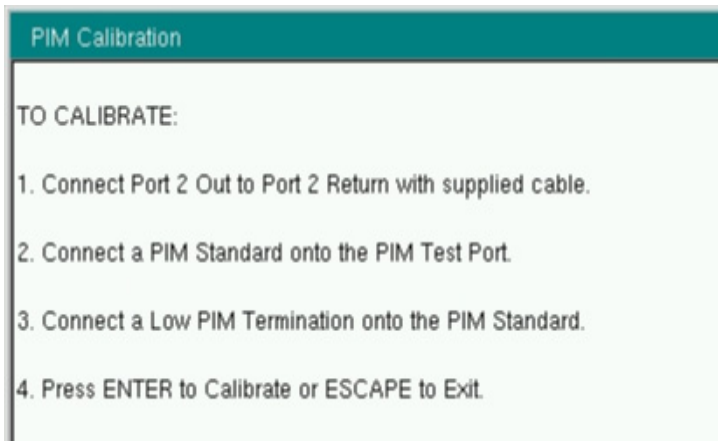

**Figure 2-2.** PIM Calibration Start Prompt

4. Follow its steps:
  - a. Connect Port 2 Out to Port 2 Return with supplied cable.
  - b. Connect a PIM Standard device on to the PIM Test Port.

- c. Connect a Low PIM Load device (p/n 2000-1749-R) onto the PIM standard device.
- 

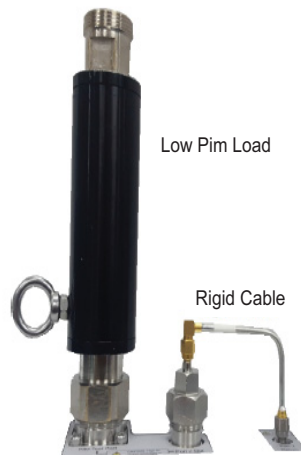

---

**Figure 2-3.** 2-Port Calibration Set Up-Phase 1

- d. When all the torque values have been confirmed, press **Enter** to start calibration.
  5. When the calibration completes, the instrument shows the this prompt.
- 

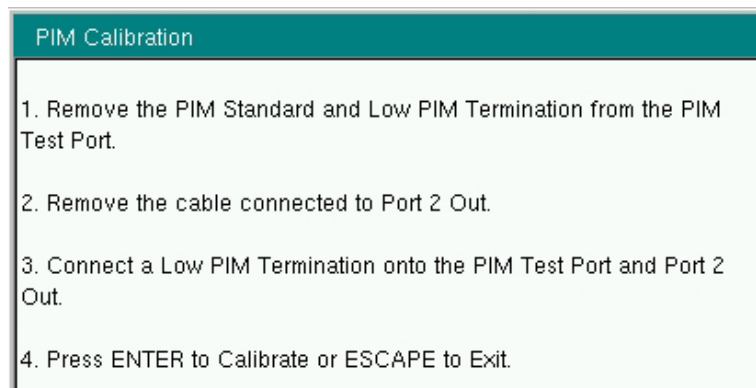

---

**Figure 2-4.** PIM Calibration Start Prompt

6. Follow its steps:
  - a. Remove the PIM standard device and the Low PIM Load device from the PIM Test Port.
  - b. Remove the cable from Port 2 Out and from Port 2 Return.
  - c. Connect one Low PIM Load device to each of PIM Test Port and Port 2 Out.

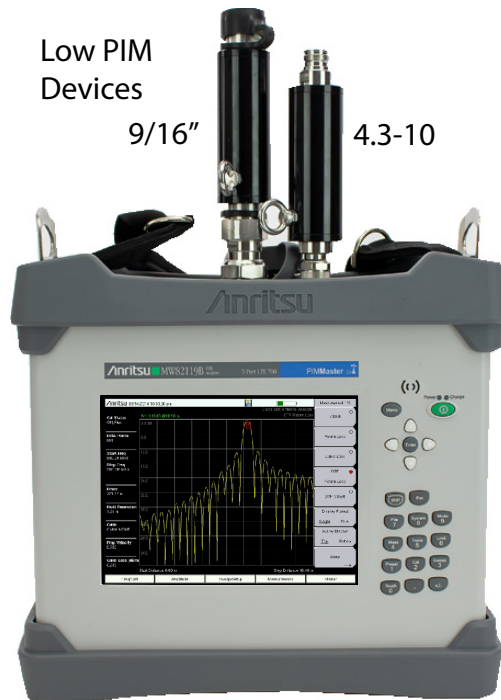

**Figure 2-5.** 2-Port Calibration Set Up

- d. When all the torque values have been confirmed, press **Enter**.
7. When this phase of the calibration completes, the PIM Master displays this prompt.

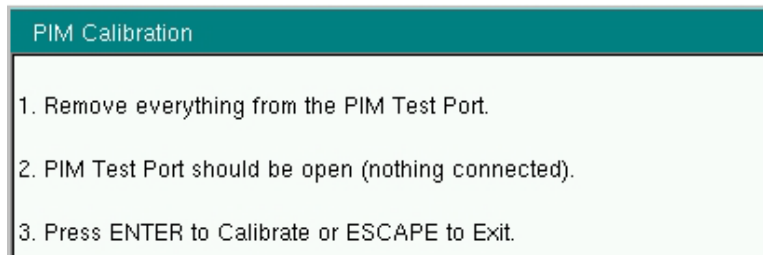

**Figure 2-6.** PIM Calibration Finish Prompt

8. Follow its steps:
  - a. Remove the load devices from the PIM Test Port and Port 2 Out.
  - b. Leave the PIM Test Port open.
  - c. Press **Enter** to complete the calibration.
9. After the third phase of the calibration is finished, depending upon the test mode (PIM v Time, PIM Distance, or Swept PIM) the last phase performs an actual test.  
The test will take as long as long as the value in Setup > Test Duration submenu.

## 2-Port Residual PIM Verification

For the 1-Port residual PIM procedure, see “[1-Port Residual PIM Verification](#)” on page 2-7. Perform this test immediately following a calibration or when instructed to do so, such as when 12 hours or more have elapsed since the existing calibration was performed. Attach the Low PIM Load to the Test Port or to the end of the PIM test cable.

<b>Note</b>	Confirm that all the connectors are clean of debris or contamination that may cause incorrect PIM measurement results.
-------------	--

### Set to Factory Preset

1. PIM measurement results.
2. Power on the PIM Master.
3. Press the Shift key and then the Mode (9) key.
4. Use the Up/Down arrow keys to highlight PIM Analyzer, and then press the Enter key to switch to PIM Analyzer mode.
5. Press the Shift key and then the Preset (1) key.
6. Press the Preset submenu key to set the instrument to the factory preset state.

### Verify Residual PIM

1. Press Freq main menu key.
2. Press 2-Port Low Band mode to ON.
3. Press Shift key and then CAL (2) Key.
4. Press Start Cal submenu key. Follow the on screen instructions until completion of the calibration.
5. Press Measurement main menu then select Swept PIM mode.
6. Leave the two test ports terminated with Low PIM Loads.
7. Press the Measurements main menu key.
8. Press the Test submenu key to initiate the test. The key has Measure underlined and goes red when the test is in progress.
9. Verify the measurement result that is displayed on the PIM Master instrument is  $< -123$  dBm with output power  $2 \times 43$  dBm.
10. Press the Setup main menu key and select High output power.
11. Enter 46 dBm.
12. Repeat [Step 6](#), [Step 7](#), [Step 8](#).
13. Verify the measurement result that is displayed on the PIM Master instrument is  $< -115$  dBm with output power  $2 \times 46$  dBm.

### PIM Standards

Table 2-1 provides PIM values and frequencies for two PIM Standards. The PIM values in this table represent PIM power for typical IM3 at 2 X 20 W.

**Table 2-1.** PIM Value Versus Frequency for PIM Standards – with Typical IM3 at 2 X 20 W

Option	F1 (MHz)	F2 (MHz)	IM3 (MHz)	-80 dBm at 1775 MHz PN: 1091-390-R	-80 dBm at 910 MHz PN: 1091-403-R	-80 dBm at 1730 MHz PN: 1091-446-R
600	617	640	663	-88 dBm -131 dBc	-80 dBm -123 dBc	-93 dBm -136 dBc
700 (lower)	734	757	711	-87 dBm -130 dBc	-81 dBm -124 dBc	-87 dBm -130 dBc
700 (upper)	734	757	780	-86 dBm -129 dBc	-80 dBm -123 dBc	-90 dBm -133 dBc
701, 702 (lower)	768	803	733	-87 dBm -130 dBc	-81 dBm -124 dBc	-88 dBm -131 dBc
701, 702 (upper)	768	803	838	-86 dBm -129 dBc	-80 dBm -123 dBc	-89 dBm -132 dBc
703 (lower)	734	757	711	-87 dBm -130 dBc	-81 dBm -124 dBc	-87 dBm -130 dBc
703 (upper) <sup>a</sup>	734	757	780	-86 dBm -129 dBc	-80 dBm -123 dBc	-90 dBm -133 dBc
850	869	894	844	-86 dBm -129 dBc	-80 dBm -123 dBc	-85 dBm -128 dBc
800	791	821	851	-86 dBm -129 dBc	-80 dBm -123 dBc	-90 dBm -133 dBc
900, 902	935	960	910	-86 dBm -129 dBc	-80 dBm -123 dBc	-85 dBm -128 dBc
180	1805	1880	1730	-80 dBm -123 dBc	-74 dBm -117 dBc	-80 dBm -123 dBc
194 (PCS/AWS)	1930	2130	1730	-80 dBm -123 dBc	-74 dBm -117 dBc	-80 dBm -123 dBc
194 (PCS)	1930	1990	1870	-78 dBm -121 dBc	-72 dBm -115 dBc	-78 dBm -121 dBc
210	2110	2170	2050	-78 dBm -121 dBc	-72 dBm -115 dBc	-77 dBm -120 dBc
260	2620	2690	2550	-75 dBm -118 dBc	NA	-73 dBm -116 dBc

a. For option 703, the upper band is available only in 1-port mode.

#### Note

Typical values are shown. PIM Standards can vary  $\pm 3$  dB due to manufacturing variation. Record the starting value of your PIM Standard, and use that value for test equipment verification.

## Verifying the PIM Test Cable

**Note**

When testing, cables are connected and disconnected many times. In order to save wear on the PIM test port cables and adapters, Anritsu recommends removing the O-rings. This allows getting a sufficiently tight connection without unnecessary stress on the connectors. In the field, O-rings are important to maintain connection integrity over long time periods. Connections must be torqued to specifications in order to ensure that they prevent water intrusion.

During your test, if the DUT connector has an o-ring, leave it in place and tighten to the correct torque.

If calibration was performed on the instrument test port, then you must next verify the PIM performance of the test cable.

1. Connect a test cable to the PIM Master and terminate the other end with a Low PIM Load.
2. From the Measurements Menu, press the PIM vs. Time submenu key followed by the Test submenu key so that **Measure** is underlined.
3. During the test, flex the test cable and verify that the PIM level of the test cable and the Low PIM Load are at least 10 dB below the pass / fail criteria for the DUT.  
If the test cable fails, inspect the connections to ensure that they are clean and tight. If poor performance persists, then repeat the calibration process.
4. If the PIM level of the setup is within specification, then disconnect the Low PIM Load and connect the test cable to the DUT for a PIM measurement.

## Checking for External Interference

Before performing a PIM test on an antenna system, verify that external interference is not present at the selected IM frequency.

1. Connect a test cable from the PIM Master to the DUT.
2. Press the **Measurements** main menu key and then press Noise Floor to open the Noise Floor submenu.
3. From the Noise Floor submenu, press the Test submenu key so that **Measure** is underlined. This will perform a Noise Floor - Time View measurement.
4. Verify that the external noise level at the selected IM frequency is below the required system pass / fail threshold for PIM.
5. If high noise is detected, press the **Noise Floor Spectrum View** submenu key. If a calibration has not already been performed for this feature, press the **Start Cal Spectrum View** submenu key and follow the on-screen instructions.
6. Press the **Test** submenu key so that **Measure** is underlined. This will perform a swept noise floor measurement to help identify which frequencies in the uplink band are clear of interference. Marker 2 automatically shows the location of the current IM frequency.

## Making PIM Measurements

1. Press the **Measurements** main menu key and then press one of the measurement submenu keys (PIM vs. Time or Swept PIM).
2. From the Measurements menu, press the Test submenu key so that Measure is underlined.
3. During the test, tap connectors and the antenna.  
**Note:** Set the test duration time so that you can tap all desired areas.
4. After the measurement is complete, press the Save Measurement submenu key, provide an appropriate name, and save the measurement.

The PIM Master continually monitors Return Loss at the two PIM test frequencies while performing a PIM test. If the Return Loss exceeds  $-6$  dB, then the PIM test will be terminated, and a warning message will appear saying, "Warning! High Reflection from measurement path!"

**Note**

If this message appears, use a DTF measurement (using Option 331 or a Site Master) to identify the location of the high reflections.

An option exists to by-pass the high reflection warning and continue testing into a high return loss system. The PIM value measured may not be accurate when high reflections are present. This option should be exercised by experienced users for troubleshooting only.

## Measurement Types

From the measurements menu (refer to ["Measurements Menu" on page 2-18](#)), you can select four measurement types:

### PIM versus Time

This measurement tracks instantaneous PIM and also records Peak PIM levels throughout a fixed frequency PIM test. It is useful for dynamic PIM tests and provides a visual indication of the stability of the system under test.

### Noise Floor

Two different Noise Floor measurements are available to evaluate Rx interference before making a PIM measurement. For each measurement, Tx power is OFF. Time View allows you to check for external interference at the IM frequency being measured. Spectrum View allows you to view interference levels across the current Rx frequency range.

The IM products of interest are in the same frequency range that is used by mobile user equipment to communicate with the base station. It is therefore possible for nearby mobile equipment to generate signals that are high enough to interfere with your PIM measurement.



## Distance-to-PIM

Distance-to-PIM (DTP) is similar to Distance-to-Fault (DTF), which Anritsu introduced in the Site Master for identifying the location of impedance mismatches in a feed line. DTP quickly and accurately identifies the location of PIM faults inside the feed system as well as beyond the antenna.

Distance-to-PIM is a swept measurement that enables identification of the location of multiple PIM sources in the RF path. Distance-to-PIM is an analysis feature only, and it should not be used as a pass / fail test.

## Swept PIM

PIM measurements are the vector sum of all PIM signals that are generated on a line at the IM frequency being tested. When multiple PIM sources exist, it is possible for the signals to combine out of phase at a particular test frequency to indicate a passing result when the individual PIM levels are actually failures. A Swept PIM test varies the IM frequency over a range of frequencies to provide you with a clearer picture of the true PIM performance of the system.

## Adding a Limit Line

1. Press the **Shift** key and then the **Limit (6)** key.
2. Press the Limit (Upper / Lower) submenu key to select the desired limit line, Upper or Lower.

<b>Note</b> The upper limit must be On in order to use the Limit Alarm or the Pass Indicator.
---

3. Activate the selected limit line by pressing the On Off submenu key so that On is underlined.
4. If necessary, press the Set Default Limit submenu key to redraw the limit line in view.
5. Press the Amplitude submenu key to set the Limit value.
6. Press the Limit Alarm submenu key to toggle the alarm setting On and Off. The current setting is underlined.

Although the instantaneous PIM values may be displayed in white numerals at the end of a measurement, if the measured PIM value exceeded the upper limit setting at any time during the measurement, then the Peak PIM values will remain displayed with red numerals when the measurement is complete. See [Figure 3-2 on page 3-5](#) for an example of this condition.

## 2-5 Setting Up Markers

Press the **Marker** main menu key to display the Marker menu.

### Selecting, Activating, and Placing a Marker

1. Press the Marker 1 2 3 4 5 6 submenu key and then select the desired marker using the touch screen marker buttons. The selected marker is underlined on the Marker submenu key.
2. Press the On Off submenu key so that On is underlined. The selected marker is displayed in red and ready to be moved.
3. Markers can be moved by touching the desired location on the screen, or by using the **Arrow** keys.
4. Repeat [Step 1](#) through [Step 3](#) to activate and move additional markers.

### Selecting, Activating, and Placing a Delta Marker:

1. Press the Marker 1 2 3 4 5 6 submenu key and select the desired marker (to become a delta marker). The selected marker is underlined.
2. Press the Delta On Off submenu key so that On is underlined. The selected marker is displayed in red and ready to be moved.
3. Touch the screen or use the **Arrow** keys to move the delta marker to the desired feature.
4. Repeat [Step 1](#) through [Step 3](#) to activate and move additional delta markers.

### Viewing Marker Data in a Table Format

The marker table is available only for Distance-to-PIM measurements. It is not available for PIM vs. TIME, Noise Floor, or Swept PIM. To view the table:

- Press the Marker Table submenu key so that On is underlined. All marker and delta marker data are displayed in a table under the measurement graph.

## 2-6 Saving Measurements

1. Press the Save Measurement submenu key on the Measurements menu.
2. Press the Change Save Location submenu key and set the current location to be the USB flash drive or internal memory, and then press **Set Location**.
3. Press Change Type (Setup/JPG/...).
4. Press the JPEG Capture submenu key (to select Full or Graph Only), if desired. Then press **Enter**.
5. Enter the file name using the touch keyboard (and Quick Name Matrix, if desired) and press **Enter** (touch screen or hard key).

**Note**

After the Save Location and File Type are changed, these settings will remain in effect until manually changed again.

## 2-7 Menu Map

Figure 2-7 shows the map of the general PIM Analyzer menus that are common to all PIM measurements. The following sections describe the associated menus and submenus. Refer to the PIM Analyzer chapters for specific menus and measurements. Menu maps typically display all possible submenu keys, although some keys and some menus are displayed on the instruments only under special circumstances (refer to menu descriptions for details).

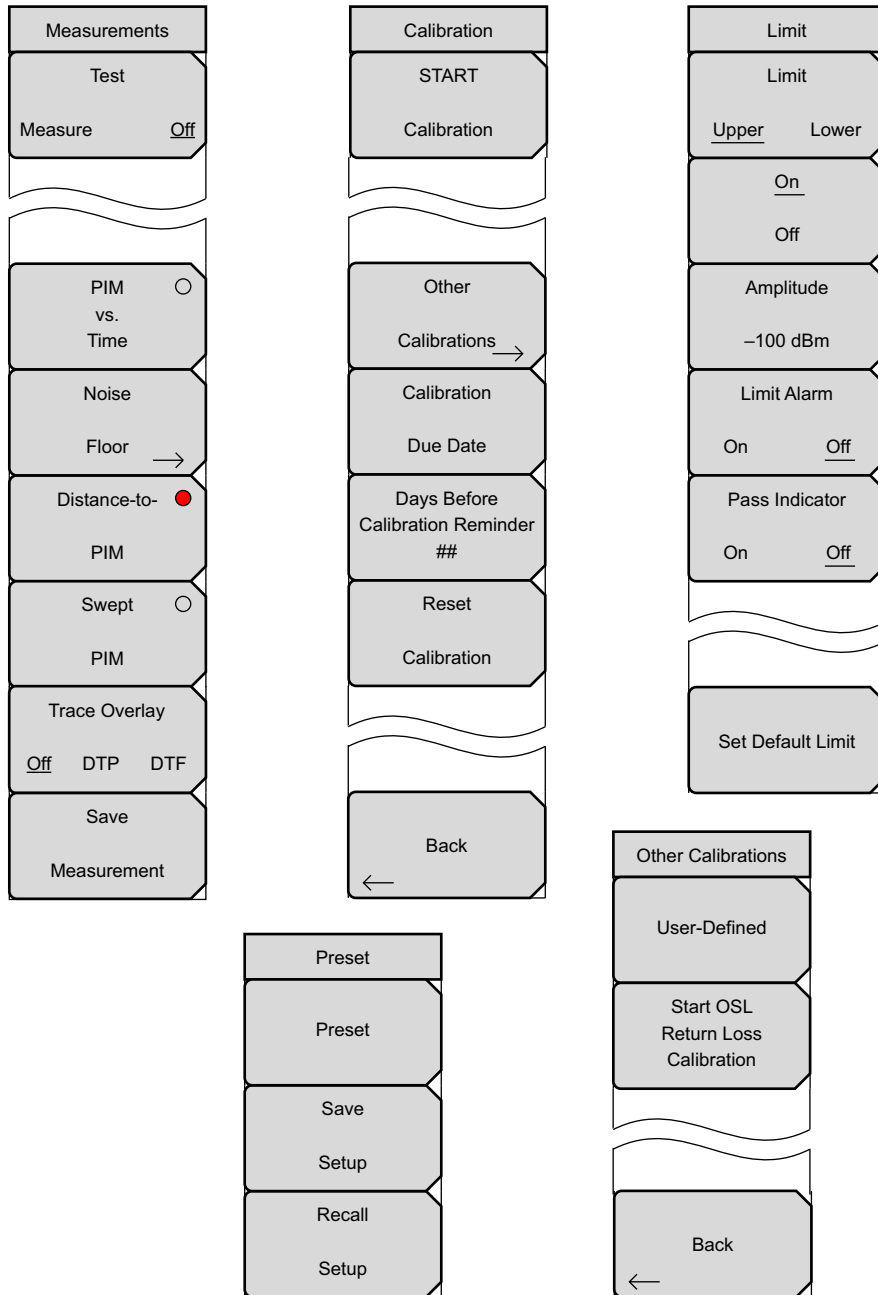

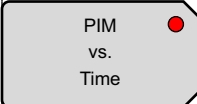
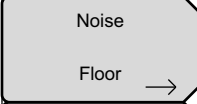
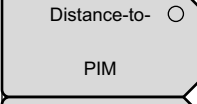
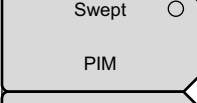
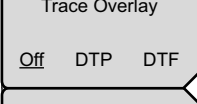
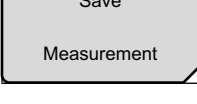

Figure 2-7. PIM Analyzer Menu Map

## 2-8 Measurements Menu

Key Sequence: **Measurements**

	<p><b>Test</b>  <b>Measure Off:</b> Press this submenu key to start any PIM measurement. When a measurement is being made, <b>Measure</b> is underlined on this submenu key, and the key is highlighted in red (see <a href="#">Figure 2-9 on page 2-19</a>). Also, the red <b>RF-ON</b> light on the top of the PIM Master is <b>On</b> during a measurement (except Noise Floor).</p>
	<p>When the measurement time is completed (<b>Setup</b> &gt; Test Duration), <b>Off</b> is underlined on this submenu key. While a measurement is being made, press this submenu key to immediately terminate the active measurement.</p> <p><b>PIM vs. Time:</b> Press this submenu key to set the instrument into the PIM versus Time measurement mode. In this measurement, Tx power is On.</p>
	<p><b>Noise Floor:</b> Press this submenu key to test for Rx interferers before making a PIM measurement. In this measurement, Tx power is Off.</p> <p>The Noise Floor Test key is shown in the <a href="#">“Noise Floor Menu” on page 4-6</a>.</p>
	<p><b>Distance-to-PIM:</b> Press this submenu key to set the instrument into the Distance-to-PIM measurement mode.</p>
	<p><b>Swept PIM:</b> Press this submenu key to set the instrument into the Swept PIM measurement mode.</p>
	<p><b>Trace Overlay</b>  <b>Off DTP DTF:</b> Press this submenu key to toggle Trace Overlay Off and On for Distance-to-PIM or Distance-to-Fault. This submenu key is displayed only in Distance-to-PIM measurement mode. Use this key to view the trace, as described in <a href="#">Section 5-6 “Trace Overlay” on page 5-8</a>. If no previous DTP trace is stored, then setting this key to DTP automatically copies the active trace to memory.</p>
	<p>DTF toggles on the current DTF trace or a DTF trace from memory as an overlay for subsequent DTP measurements. If no DTF trace has been loaded, then DTF cannot be selected. Refer to <a href="#">“Trace Menu, Distance-to-PIM” on page 6-5</a> for instructions for loading a DTF trace.</p> <p><b>Save Measurement:</b> Press this submenu key to open the Save menu and its dialog box. Then enter a name and save the current measurement to file. The file type defaults to measurement, and the appropriate extension is added, based on the current measurement mode.</p>

**Figure 2-8.** Measurements Menu

## 2-9 Test Submenu Key During Measurement

When a measurement is being made, Measure is underlined on this submenu key, and the whole Test key is highlighted in red (as shown in [Figure 2-9](#)).

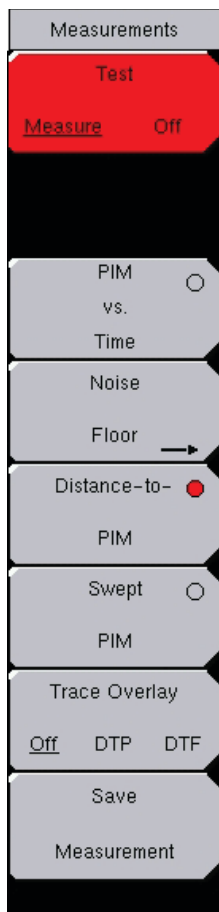

**Figure 2-9.** Test Submenu Key Highlighted in Red

Also, during PIM vs. Time and Swept PIM measurements, RF ON is displayed in red in the PIM Summary Table (See [Figure 3-3 on page 3-6](#)).

**Warning**

Any time the LED on the PIM Master is lit there is RF energy on the PIM Test Port out or the Port 2 Out port. Make sure you follow all precautions given in this publication to avoid injury or equipment damage.

## 2-10 Limit Menu

When measurement type is PIM versus Time, Noise Floor, or Swept PIM:

Key Sequence: **Shift > Limit (6)** key

Two types of limit lines can be specified, lower limit lines and upper limit lines. Limit lines can be used for pass/fail criteria or for visual reference only.

Limit	<b>Limit</b>
Limit	<b>Upper Lower:</b> This submenu key selects which limit line (Upper or Lower) will be active for editing. The limit line that is currently selected for editing is underlined.
Upper Lower	<b>On/Off:</b> This submenu key turns On or Off the active limit (upper or lower).
On	<b>Amplitude:</b> Press this submenu key to set the amplitude value of the active limit line, Upper or Lower. A value is entered by using the number keypad. Press the <b>+/-</b> key for negative values.
Off	After entering a value, press the dBm or dBc submenu key and then the <b>Enter</b> key, or press the <b>Enter</b> key twice.
Amplitude	
-100 dBm	
Limit Alarm	<b>Limit Alarm</b>
On Off	<b>On Off:</b> Pressing this submenu key toggles the alarm function ON and OFF for the Upper limit line. When ON and when the upper limit is exceeded, the measurement text is displayed in red in the PIM Summary Table, and an audible alarm sounds. The Limit Alarm does not function with the lower limit line.
Pass Indicator	
On Off	<b>Pass Indicator</b>
	<b>On Off:</b> Pressing this submenu key toggles the Pass Indicator function ON and OFF for the Upper limit line. When ON and when the upper limit is exceeded, the measurement text is displayed in red, and an audible alarm sounds. If the measurement trace remains below the limit line, then at the end of the measurement, PASS is displayed in large green letters in the measurement display. If any measured point exceeds the limit, then FAIL is immediately displayed in large red letters in the measurement display. This message display allows you to see the pass or fail indication from a distance. The Pass Indicator does not function with the lower limit line.
Set Default Limit	<b>Set Default Limit:</b> Pressing this submenu key sets the active limit line to the default limit line value, depending upon which limit is active. The inactive limit line is not altered.

Figure 2-10. Limit Menu

## 2-11 Calibrate Menu

Key Sequence: **Shift > Cal (2)**

<div style="border: 1px solid black; padding: 2px; margin-bottom: 2px;">Calibration</div> <div style="border: 1px solid black; padding: 2px; margin-bottom: 2px;">START</div> <div style="border: 1px solid black; padding: 2px; margin-bottom: 2px;">Calibration</div>	<p><b>START Calibration:</b> Press this submenu key to begin calibrations for Distance-to-PIM (DTP), Swept PIM, PIM vs. Time, and Noise Floor - Time View for the current instrument settings. You will need a PIM standard and a Low PIM Load. Follow the on-screen prompts until the calibrations are complete. If you are performing a Noise Floor Spectrum View measurement, a separate calibration is required. Press the Start Cal Spectrum View button in the <a href="#">“Noise Floor Menu”</a>, and then follow the on-screen instructions to calibrate the Spectrum View (refer to the <a href="#">“Other Calibrations Menu”</a> and the <a href="#">“User Defined Calibration Dialog Box”</a> on page 2-22).</p>
<div style="border: 1px solid black; padding: 2px; margin-bottom: 2px;">Other</div> <div style="border: 1px solid black; padding: 2px; margin-bottom: 2px;">Calibrations →</div>	<p><b>Other Calibrations:</b> Press this submenu key to display the <a href="#">“Other Calibrations Menu”</a> on page 2-22.</p>
<div style="border: 1px solid black; padding: 2px; margin-bottom: 2px;">Calibration</div> <div style="border: 1px solid black; padding: 2px; margin-bottom: 2px;">Due Date</div>	<p><b>Calibration Due Date:</b> Press this submenu key to enter the date (Day, Month, and Year) when your PIM Master requires calibration.</p>
<div style="border: 1px solid black; padding: 2px; margin-bottom: 2px;">Days Before</div> <div style="border: 1px solid black; padding: 2px; margin-bottom: 2px;">Calibration Reminder</div> <div style="border: 1px solid black; padding: 2px; margin-bottom: 2px;">##</div>	<p><b>Calibration Reminder:</b> Press this submenu key to display a Calibration Reminder notice in Days. You can use the number keypad to key in a new reminder duration. Press <b>Esc</b> or any other main menu key or submenu key to dismiss the reminder notice. Set to zero to disable.</p>
<div style="border: 1px solid black; padding: 2px; margin-bottom: 2px;">Reset</div> <div style="border: 1px solid black; padding: 2px; margin-bottom: 2px;">Calibration</div>	<p>If calibration is due in less time than this setting, then the reminder notice is displayed when instrument power is turned On.</p> <p><b>Reset Calibration:</b> Press this submenu key to delete any saved calibration files that match the current instrument settings (power level, PIM Order, and so forth). These can be calibrations for any PIM analyzer function at the set power level.</p>
<div style="border: 1px solid black; padding: 2px; margin-bottom: 2px;">Back</div>	<p><b>Back:</b> Press the Back submenu key to return to the previous menu.</p>

**Figure 2-11.** Calibration Menu

**Note** During calibration, RF is On, but the RF ON message is not displayed. The CALIBRATION IN PROCESS... message is displayed in red letters on the measurement screen.

## 2-12 Other Calibrations Menu

Key Sequence: **Shift > Cal (2) > Other Calibrations**

Other Calibrations	<p><b>User-Defined:</b> Press this submenu key to open the User-Defined Calibration dialog box shown in <a href="#">Figure 2-13</a>. This dialog lets you enable specific calibrations or multiple calibrations at multiple power levels to be performed in sequence. Select the desired calibrations to be performed and enter the desired power levels. Selecting All Integer Powers performs the calibrations at every integer power level (20, 21, 22,..., 46) dBm. The estimated calibration time based on the current selections is displayed at the bottom of the dialog box. Press <b>Start Calibration</b> and follow the screen prompts until the calibration is complete.</p> <p><b>Start OSL Return Loss Calibration:</b> Press this submenu key to begin calibration of the PIM test port using an Open-Short-Load (OSL) precision calibration standard. A less accurate calibration method is used during the Standard Calibration process to support DTF measurements through the PIM test port. This OSL calibration is provided to support cases where higher DTF magnitude accuracy is desired.</p> <p><b>Back:</b> Press the Back submenu key to return to the “<a href="#">Calibrate Menu</a>” on <a href="#">page 2-21</a>.</p>
User-Defined →	
Start OSL Return Loss Calibration	
Back ←	

**Figure 2-12.** Other Calibrations Menu

### User Defined Calibration Dialog Box

Key Sequence: **Shift > Cal (2) > Other Calibrations > User-Defined**

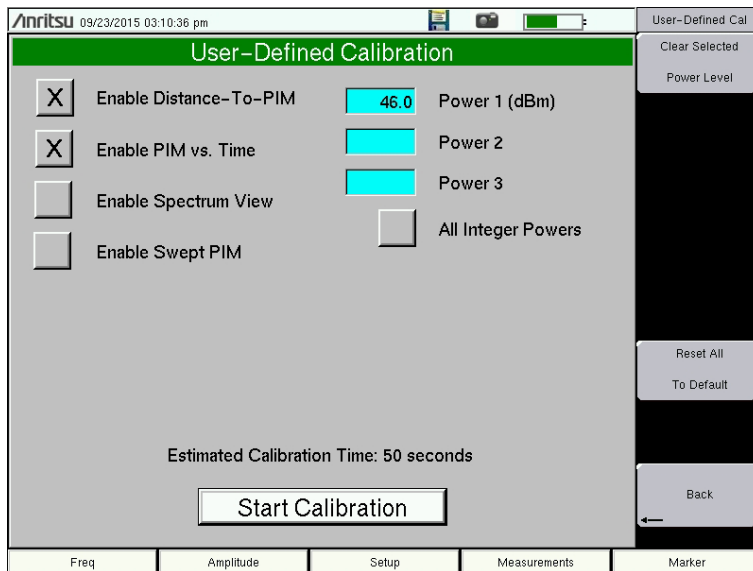

**Figure 2-13.** User-Defined Calibration Dialog Box



# Chapter 3 — PIM versus Time

The Anritsu PIM Master is capable of producing 80 Watts of RF power in the cellular communications bands. Users must take precautions to minimize exposure to these RF fields:

## **Warning**

Always terminate the PIM output port of the test equipment into a load, a loaded line, or a line that will radiate or absorb the energy before beginning a PIM test.

Confirm that the PIM Master RF power is off after a PIM test.

Always confirm that the PIM RF power is off before disconnecting a coaxial connection, otherwise RF burns may result. Immediate burns to fingers or eyes can result from exposure to live connectors.

Ensure that all antennas under test are placed so that no personnel are exposed to RF levels that exceed the maximum allowable exposure.

## **3-1 Introduction – PIM versus Time Analyzer**

The PIM Master includes a PIM versus Time measurement that tracks not only the instantaneous PIM level but also records the Peak PIM level experienced throughout a fixed frequency PIM test. This measurement is useful for dynamic PIM tests because it not only captures the Peak PIM value for pass/fail determination, but provides a visual indication of the stability of the system under test.

A PIM versus Time measurement is the basic test to pass or fail a site. Distance-to-PIM is a diagnostic tool to find any PIM that is detected in the PIM versus Time measurement. Noise Floor measurements reveal any external interference that might produce undesirable PIM test results.

### 3-2 Trace Mode

Two trace modes are available to optimize performance. They are based on the type of measurement being conducted. The instrument settings summary displays the Trace Mode setting. (See the PIM Master User Guide 10580-00400 for more information on other Front Panel Display areas.)

Fast mode is available for dynamic PIM testing, in which maximum responsiveness is desired. New data points are reported to the user approximately eight times per second to provide rapid feedback during dynamic impacts.

Low Noise mode is available to increase accuracy for low signal level measurements. This mode increases the number of samples collected by a factor of five for each reported data point. Noise variation is distributed over a larger number of samples, which results in reduced peak-to-peak variation for low signal level measurements.

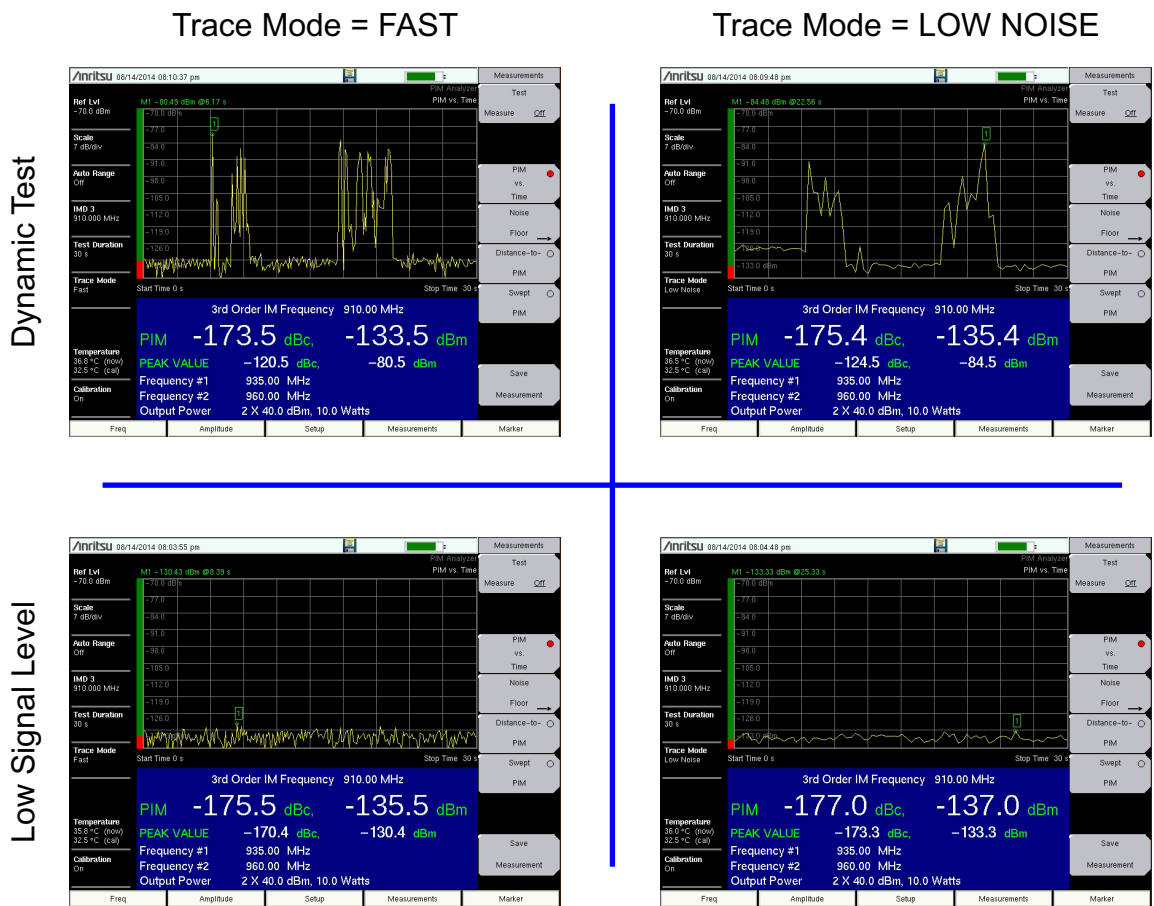

Figure 3-1. Fast and Low Noise Trace Modes

Use Setup>Trace Mode to change this setting.

### 3-3 PIM vs. Time Measurement Setup

Before performing a PIM vs. Time measurement, the PIM Master must be calibrated (refer to section “[Calibrating the PIM Analyzer](#)” on page 2-4).

1. Turn on the PIM Master.
2. Connect the DUT to the test port connector of the PIM Master.

#### Warning

Confirm that connections are secure and properly torqued. The PIM test port emits high-power RF signals which can cause bodily injury. Anritsu recommends using a torque wrench for this connection. The torque wrench is included in the PIM accessory kit (refer to your Technical Data Sheet for part numbers).

This device (DUT) may be the main feeder cable from the tower or a simple jumper cable. The DUT must be connected to a Load device, such as a low PIM Load or an Antenna.

#### Caution

Do not use a Site Master precision load as the Load device for PIM tests because they are not designed to handle the power of the PIM Master and will become damaged immediately.

### Configure the PIM Test

1. Frequencies F1 and F2 must be within the ranges that are defined in [Table A-1](#), “[PIM Master Carrier Bands and Frequencies](#)” on page A-1. If an incorrect entry is made, then an error message appears to indicate the allowable frequency range for F1 or F2.
2. Press the **Measurements** main menu key and then press the PIM vs. Time submenu key.
3. Verify that the Output Power is set to the desired power level.
4. When configuring the test for two-port PIM, remove the cable 2000-1990-R. The bottom of the graphic display on the PIM Master 700 shows whether the instrument is in one- or two- port mode.

### Intermodulation Distortion

The intermodulation distortion (IM<sub>x</sub>) is a mathematical function of F1 and F2.

$$3\text{rd Order Intermodulation (IM}_3\text{)} = 2F_1 - F_2 \text{ or } 2F_2 - F_1$$

$$5\text{th Order Intermodulation (IM}_5\text{)} = 3F_1 - 2F_2 \text{ or } 3F_2 - 2F_1$$

$$7\text{th Order Intermodulation (IM}_7\text{)} = 4F_1 - 3F_2 \text{ or } 4F_2 - 3F_1$$

### Example Intermodulation Calculation

Finding IM<sub>3</sub> when F1 = 1930 MHz and F2 = 1990 MHz:

$$\text{IM}_3 = 2F_1 - F_2 = 2(1930) - 1990 = 1870 \text{ MHz}$$

or

$$\text{IM}_3 = 2F_2 - F_1 = 2(1990) - 1930 = 2050 \text{ MHz}$$

The PIM Master uses 1870 MHz (low-side IMx) as the center frequency. The PIM Master always uses the lower IMx value and does not set it to the high-side IMx frequency, except for instruments that are designed to measure the high-side product (the MW82119B-0700, for example).

In addition, the IMx selection must be inside one of the PIM Master receiver bands in order to make a PIM measurement (refer to [Table A-1, “PIM Master Carrier Bands and Frequencies” on page A-1](#)).

If the IMx frequency does not fall within one of these bands, then the PIM Master displays a warning message indicating the acceptable IMx range. The font color for the IMx frequency in the PIM summary table changes to red until acceptable frequency selections are made.

1. Press the **Carrier F1** submenu key to enter the frequency of Carrier F1 by using the keypad or the **Arrow** keys. When entering a frequency by using the keypad, the submenu key labels change to GHz, MHz, kHz, and Hz. Press the appropriate unit key.
2. Repeat [Step 1](#) for Carrier F2.
3. Press the **Intermod Order** submenu key so that the desired intermodulation frequency order to be viewed is underlined. 3rd order is the most commonly chosen measurement .

<b>Note</b>	The PIM Parameters screen (press the PIM Aid submenu key) displays the IM frequencies for the F1 and F2 frequencies that are entered.
-------------	---

### Amplitude Setup

1. Press the **Amplitude** main menu key to display the Amplitude menu.
2. Press the **Reference Level** submenu key. The numeric value and units turn red indicating that the settings are ready for editing. Enter the desired reference level by using the keypad or the **Arrow** keys. Press **Enter**.
3. Press the **Scale** submenu key to change the division of the graticule to a setting other than the default value of 10 dBm.
4. Press the **Auto Range** submenu key so that **On** is underlined. This allows the reference level to be adjusted automatically.
5. Press the **Amplitude Tone** submenu key to have the PIM Master broadcast a tone. The frequency of the tone increases as PIM level increases.

### Power and Display Setup

1. Press the **Setup** main menu key to display the Setup menu.  
High Output Power and Low Output Power submenu keys are available for setting output power.
2. Press the **High Output Power** submenu key to set the output power range between 37 dBm and 46 dBm.
3. Press the **Low Output Power** submenu key to set the output power range between 20 dBm and 37 dBm.
4. Press **Test Duration** to set the number of seconds from 1 s to 1200 s.
5. Press the **Trace Mode** submenu key (if desired) to toggle between **Fast** and **Low Noise** modes. For additional information, refer to [Section 3-2 “Trace Mode” on page 3-2](#).

Sample Measurement

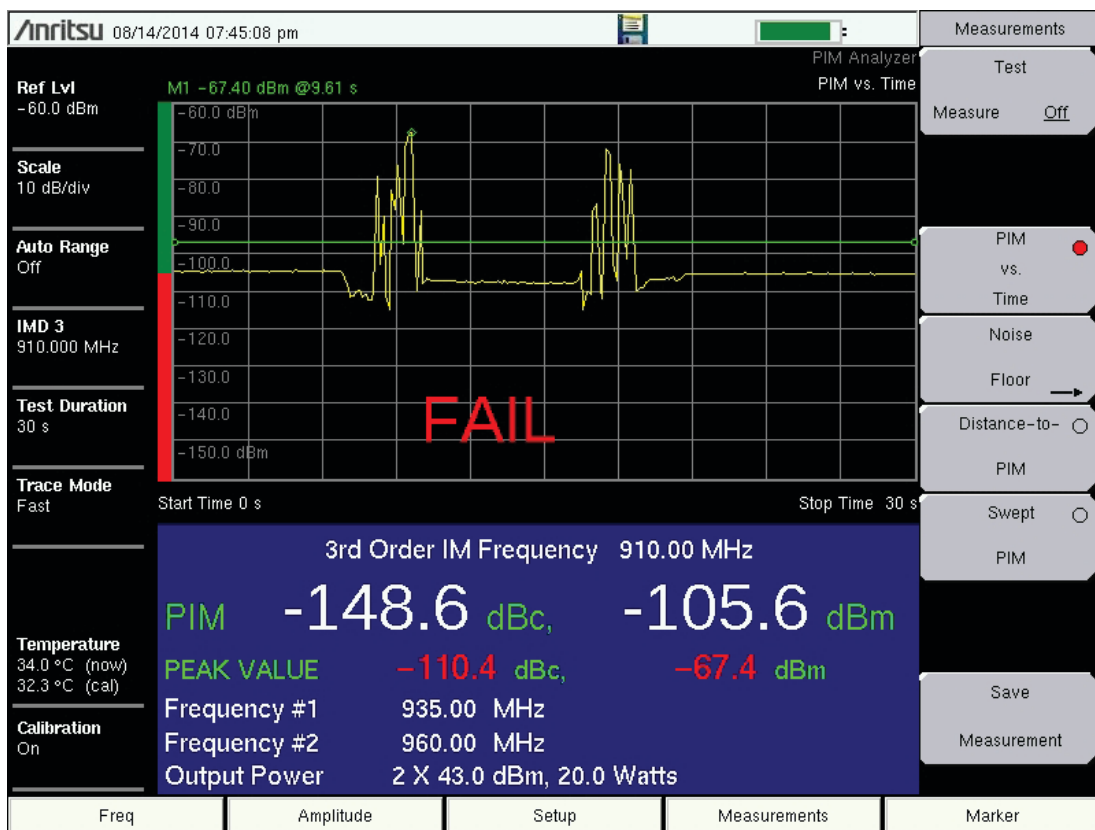

Figure 3-2. Sample Measurement with PIM at 910.0 MHz

PIM problems can be intermittent and power sensitive. This is often the case when PIM problems first begin to appear. This can be due to light corrosion, to high traffic loading, or to changing weather conditions that are activating environmental diodes. Using higher power levels can often force otherwise intermittent failures to become visible. Higher power levels may be required to find faults in a multi-carrier system or to discover microscopic arcing in connectors.

In Figure 3-2, note that the instantaneous PIM levels in the PIM Summary Table are displayed in white numerals even though the PIM value exceeded the upper limit line setting during the measurement. The instantaneous measurement values turn red while the measurement is above the limit, but return to white while the measurement is below the limit. The peak PIM values are shown in red (and remain in red) because the measurement exceeded the limit at some time during the measurement.

PIM Summary Table

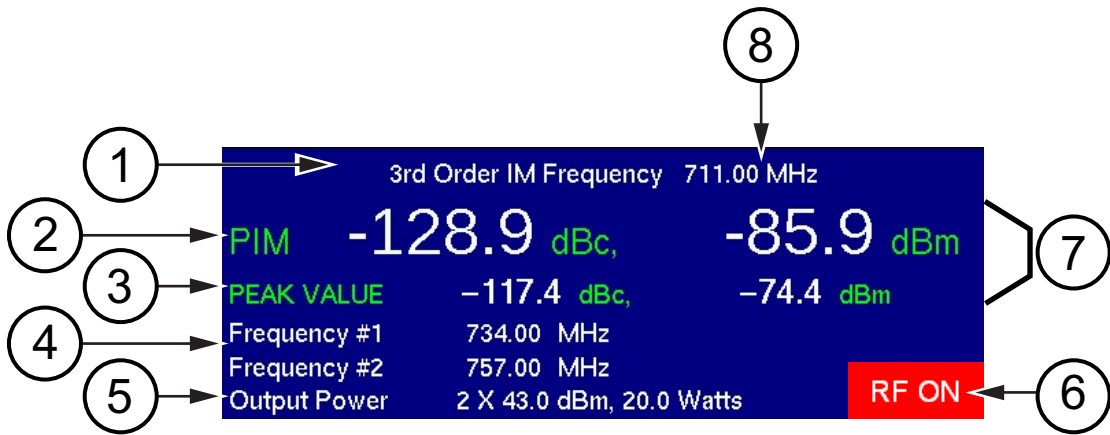

Figure 3-3. PIM Summary Information

1.	PIM Order
2.	Instantaneous PIM
3.	Peak PIM
4.	Transmit Frequencies
5.	Test Power Level
6.	RF ON Indicator
7.	Pass / Fail Indication (White = Pass, Red = Fail)
8.	PIM Frequency

In this example of the PIM Summary Table, the instantaneous PIM values (item 2) are displayed with white numerals, indicating that these values are below the upper limit value that was set for this measurement. The peak PIM values (item 3) are also displayed with white numerals, indicating that those values are within the upper limit value setting. If the measurement trace exceeds the upper limit line setting at any time during a measurement, then the peak values are displayed in red and remain red after the measurement is completed. The instantaneous PIM values (item 2) are displayed with red numerals only while the measurement exceeds the limit.

The RF ON indicator (item 6) is displayed in the PIM Summary Table only while the measurement is in progress, that is, while RF is being transmitted. The Test submenu key, in which the word Measure is underlined while the measurement is in progress, is also highlighted in red while RF is present.

Bar Graph of Instantaneous PIM

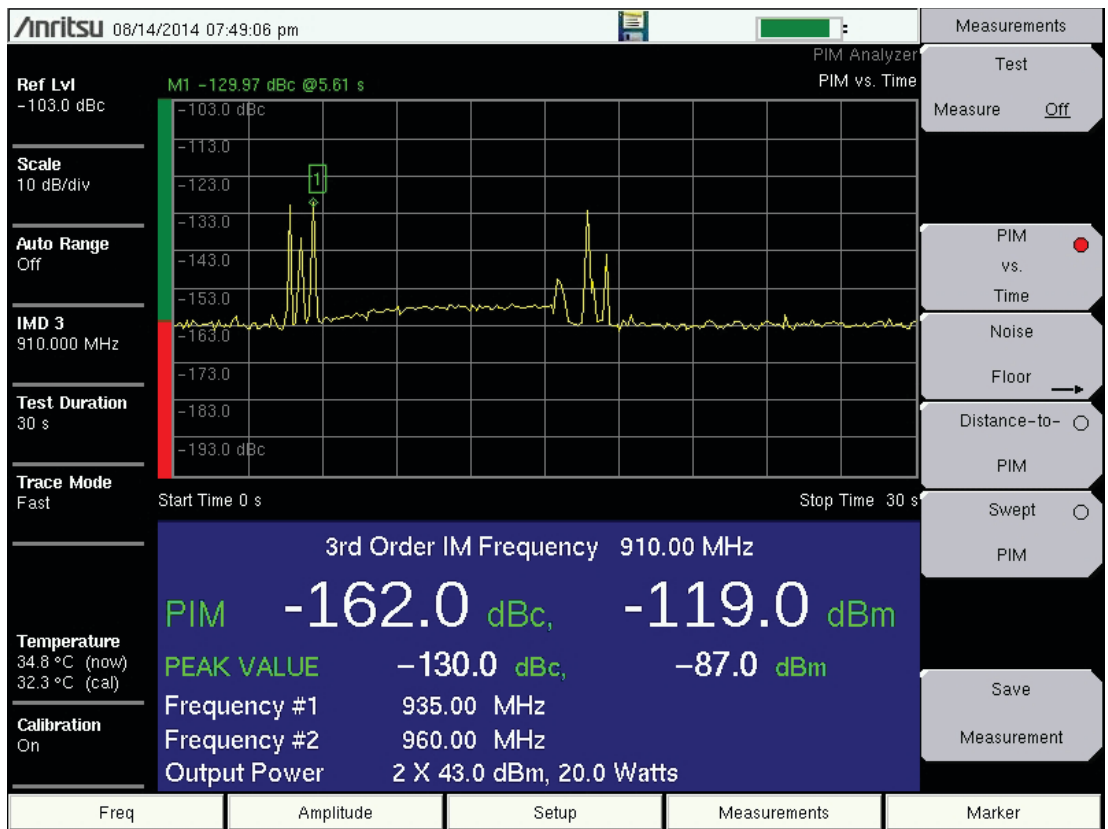
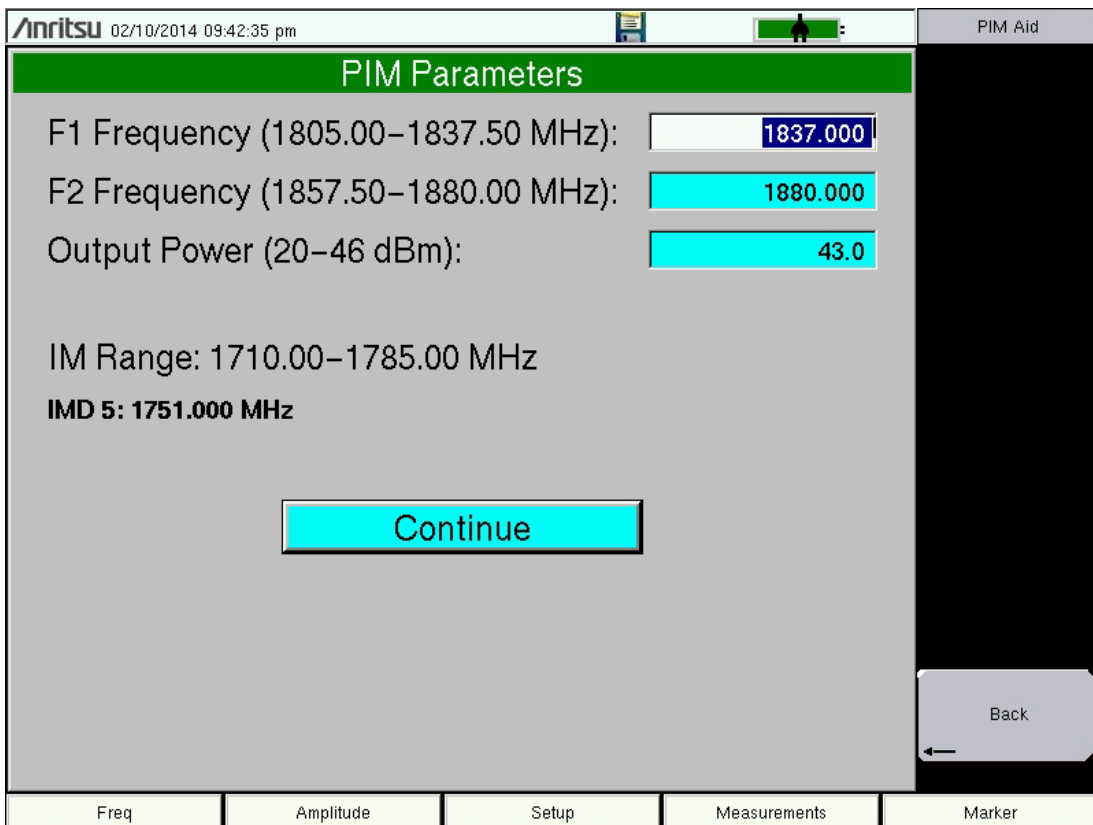

Figure 3-4. PIM versus Time

Note the PIM bar graph at the left edge of the sweep window. In this graph, the instantaneous PIM level is displayed in units of dBc by the red bar on the vertical axis. No limit was set for this particular measurement.

### PIM Parameters Dialog Box

The PIM Parameters dialog box (Figure 3-5) displays when you press the PIM Aid submenu key, which is available by pressing the **Freq** main menu key or the **Setup** main menu key. This dialog box displays the current carrier frequencies, power, and intermodulation product generated by the selected carrier frequencies. In addition, frequencies for F1 and F2 and the carrier power can be changed in this dialog box. Use the **Arrow** keys or the touch screen to scroll through the three settings (F1, F2, and Power). The chosen value changes color to indicate when the value is ready for editing. Then use the number keypad to enter a value, which must be within the range that is indicated on the screen. After editing the value, you must press the **Enter** key or the appropriate submenu key (MHz for frequency or Enter for power). The highlighting changes to indicate that the new value has been set. When all three settings are satisfactory, scroll to highlight the Continue button and press the **Enter** key, or use the touch screen to press the Continue button, or press the Back submenu key. To abort a setting, before pressing **Enter** or the MHz submenu key or the Enter submenu key, press the **Esc** key or an **Arrow** key, which allows you to enter a different value. Pressing the **Esc** key when no setting is pending returns the display to the previous menu. To abort a setting, before pressing **Enter** or the MHz submenu key or the Enter submenu key, touch the Continue button, which returns to the same previous menu as when pressing the Back submenu key.



**Figure 3-5.** PIM Parameters Dialog Box



## 3-4 Making the Measurement

1. Press the **Measurements** main menu key. The Measurements menu is displayed.
2. Begin testing by pressing the **Test** submenu key, **Measure** is underlined while the test signal is being transmitted, and the **Test** submenu key is outlined in Red. Two high-power test signals are transmitted from the PIM Master PIM test port to the DUT. PIM generated by the DUT is returned to the PIM Master. The results are displayed. The red RF On light on the PIM Master top panel illuminates during the PIM test, and **RF ON** is displayed in red in the PIM Summary Table on the measurement display screen.

<b>Note</b>	During calibration, RF is On, but the RF ON message is not displayed. The CALIBRATION IN PROCESS... message is displayed in red letters on the measurement screen.
-------------	--

Test duration is specified in the **Setup** main menu. You can terminate the test early by pressing the **Test** submenu key so that **Off** is underlined.

<b>Note</b>	When changing the IMD order, if the IM frequency is outside the Rx range, then the PIM Master will reset the F1 and F2 carrier frequencies to the default values.
-------------	---

3. Save the current measurement by pressing the **Save Measurement** submenu key. The Save dialog box opens.
4. Type a name for the measurement to be saved and press **Enter**. For additional information about file handling, refer to File Management in your PIM Master User Guide.

### 3-5 Sample of PIM versus Time Measurement

PIM testing should be conducted while subjecting the device or line under test to a dynamic stimulus. If the magnitude of the PIM that is being measured exceeds the pass / fail limit during the test, then the device or line has failed even if the PIM returns to a low level after the dynamic stress has stopped. **Figure 3-6** shows this. This trace was created by tapping on a loose RF connection, which shows that PIM in this test situation is very unstable under dynamic stress and then very good when the stress has stopped. Definitions for how to apply dynamic stimulus are defined by IEC62037 for RF cable assemblies, RF cables, Filters, and Antennas. The only problem is that this work was done with FACTORY testing in mind. The IEC specification does not currently address how to apply dynamic stress in the field. Operators, therefore, need to define their preferred test methods. The MW82119B PIM Master has the PIM versus Time measurement mode, which supports dynamic testing and keeps track of the worst case value for the duration of the test. It also compares the measured values to the pass / fail limit that you have set.

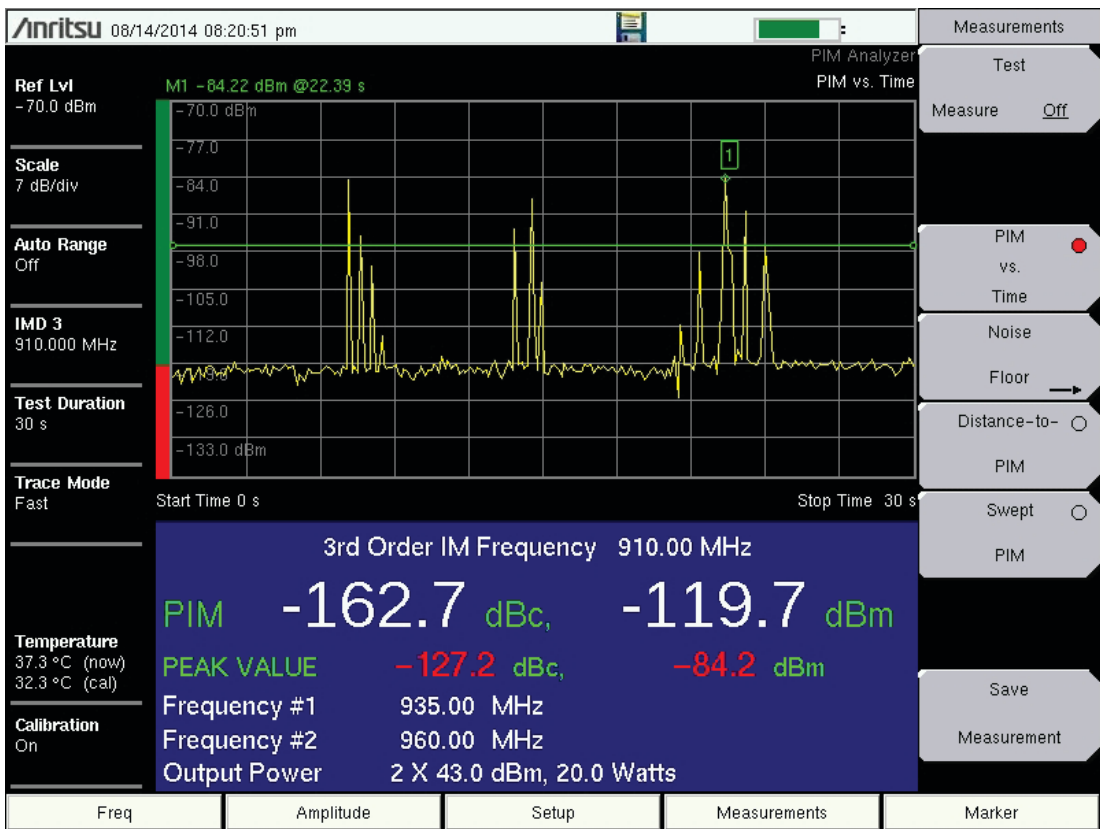

**Figure 3-6.** Dynamic Stress by Tapping a Loose Connection

Note that the peak PIM values are displayed in red because the measurement exceeded the upper limit setting.

### 3-6 Measurement with Pass Indicator

In this example, the measurement remains below the limit for the duration of the test. The Pass Indicator displays PASS in green letters. Note that the measured PIM and Peak PIM values are displayed in white numerals.

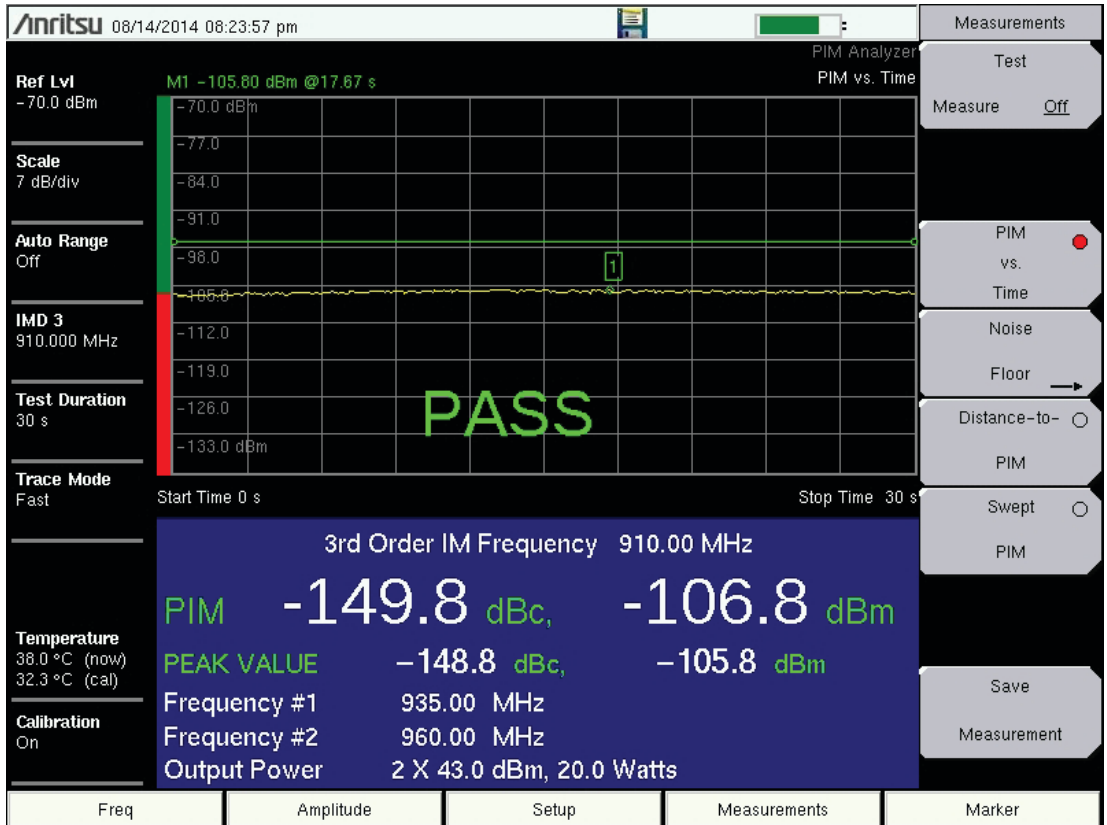

Figure 3-7. PASS Indication in PIM vs. Time Measurement

### 3-7 Menu Map

Figure 3-8 shows the map of the PIM versus Time Analyzer menus. Menu maps typically display all possible submenu keys, although some keys are displayed on the instruments only under special circumstances (refer to menu descriptions on the following pages). The following sections describe main menus and associated submenus.

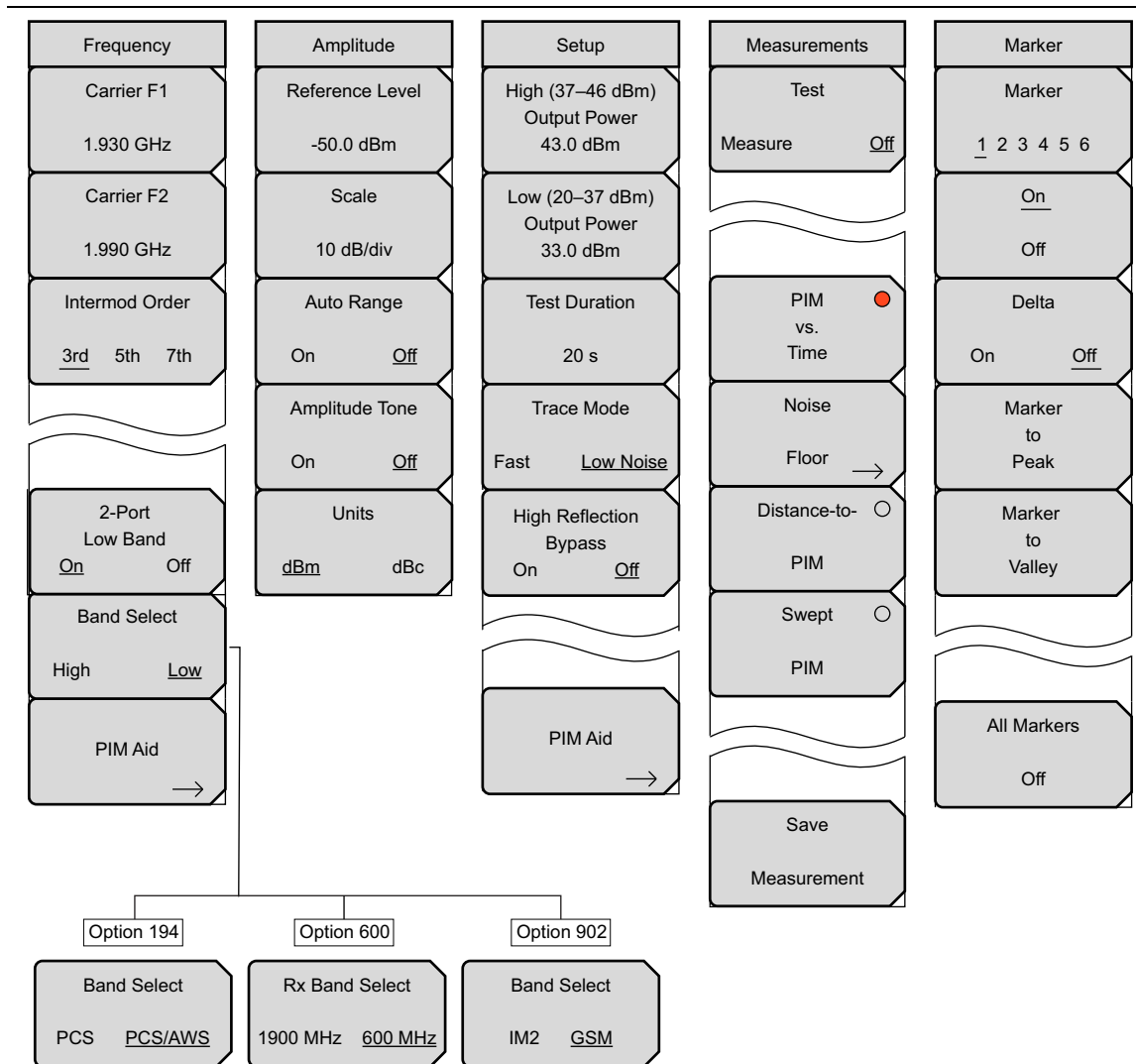

Figure 3-8. PIM vs. Time Menu Map

**Note**

The left-most main menu key is labeled **Freq** in the PIM vs. Time and the Swept PIM measurement settings. It is labeled **Distance** in the Distance-to-PIM measurement setting.

Two-port mode is restricted to low-band. Band select is active only in one-port mode.

### 3-8 Frequency (Freq) Menu

Key Sequence: **Freq**

<p>Frequency</p>	<p><b>Carrier F1:</b> Press this submenu key and enter the desired frequency using the number keypad or the <b>Arrow</b> keys. Enter a frequency within the acceptable range by referring to <a href="#">Table A-1 on page A-1</a>.</p>
<p>Carrier F1 1.930 GHz</p>	<p><b>Carrier F2:</b> Press this submenu key and enter the desired frequency using the keypad or the <b>Arrow</b> keys. Enter a frequency within the acceptable range by referring to <a href="#">Table A-1 on page A-1</a>.</p>
<p>Carrier F2 1.990 GHz</p>	<p><b>Intermod Order</b> <b>3rd 5th 7th:</b> Select the 3rd, 5th, or 7th order of intermodulation. If the selected F1 and F2 do not produce the desired IM product, the PIM Master automatically changes F1 and F2 to factory default frequencies that will generate an in-band IM product. F1 and F2 can be further adjusted if desired.</p>
<p>Intermod Order <u>3rd</u> 5th 7th</p>	<p>This submenu key is not displayed when using Option 600 or 902.</p>
<p>2-Port Low Band On Off</p>	<p><b>2-Port Low Band:</b> Selects the 2-Port mode when On and hides the Band Select key from view.</p>
<p>Band Select High <u>Low</u></p>	<p><b>Band Select</b> <b>High Low:</b> This key is visible in 1-port mode (2-Port Low Band Off). Press this submenu key to toggle the band selection to High or Low. This submenu key appears only on instruments with multiple receive ranges (see buttons below menu at left). For Option 194, the toggle choices are PCS and PCS/AWS. For Option 600, the toggle choices are 1900 MHz and 600 MHz. For Option 902, the toggle choices are IM2 and GSM.</p>
<p>PIM Aid →</p>	<p><b>PIM Aid:</b> Press this submenu key to display the PIM Parameters dialog box (see <a href="#">Figure 3-5 on page 3-8</a>). This dialog box allows editing of the current carrier frequencies and carrier power. It also displays the intermodulation products generated by the carrier frequencies.</p>
<p>Option 194 Band Select PCS <u>PCS/AWS</u></p>	
<p>Option 600 Rx Band Select 1900 MHz <u>600 MHz</u></p>	
<p>Option 902 Band Select IM2 <u>GSM</u></p>	

**Figure 3-9.** Frequency Menu

If you press the 2-Port key to On to go to 2-port mode while Band Select is in High mode, you will get this message.

Note



### 3-9 Amplitude Menu

Key Sequence: **Amplitude**

Amplitude
Reference Level
-50.0 dBm
Scale
10 dB/div
Auto Range
On      Off
Amplitude Tone
On      Off
Units
<u>dBm</u> dBc

**Reference Level:** The reference level is the top graticule line on the display, and can be set from -50 dBm to -160 dBm. A value may be entered from the number keypad. Use the **+/-** key for negative values. After entering the value press the dBm or dBc submenu key or the **Enter** key. The **Up/Down** arrow keys change the reference level in 10 dB steps, and the **Left/Right** arrow keys change the value by 1 dB.

**Scale:** The scale can be set in 1 dB steps from 1 dB per division to 15 dB per division. The value can be changed using the number keypad or the **Arrow** keys.

**Auto Range**

**On Off:** Automatically adjusts the reference level based on the input power and y-axis scale in order to display the trace on screen.

**Amplitude Tone**

**On Off:** Toggles On and Off. The frequency of the tone increases as PIM level increases.

**Units**

**dBm dBc:** Toggles the measurement display units between dBm and dBc. The amplitude for upper and lower limits automatically adjusts to the equivalent level for the selected units.

Figure 3-10. Amplitude Menu

### 3-10 Setup Menu

Key Sequence: **Setup**

<div style="border: 1px solid black; padding: 5px; margin-bottom: 5px;">Setup</div> <div style="border: 1px solid black; padding: 5px; margin-bottom: 5px;">High (37–46 dBm) Output Power 43.0 dBm</div> <div style="border: 1px solid black; padding: 5px; margin-bottom: 5px;">Low (20–37 dBm) Output Power 33.0 dBm</div> <div style="border: 1px solid black; padding: 5px; margin-bottom: 5px;">Test Duration  60 s</div> <div style="border: 1px solid black; padding: 5px; margin-bottom: 5px;">Trace Mode Fast    <u>Low Noise</u></div> <div style="border: 1px solid black; padding: 5px; margin-bottom: 5px;">High Reflection Bypass On        Off</div> <div style="border: 1px solid black; padding: 5px; margin-bottom: 5px;">PIM Aid →</div>	<p><b>High (37–46 dBm) Output Power:</b> Press this submenu key to set the output power level within the higher range for both carrier frequencies, F1 and F2 when a high power test is desired.</p> <p><b>Low (20–37 dBm) Output Power:</b> Press this submenu key to set the output power level within the lower range for both carrier frequencies, F1 and F2 when a low power test is desired.</p> <p><b>Note:</b> Power output value from the test port is twice the set output value. For example, when <b>Setup</b> &gt; Output Power is set to 20 W, total output power is 40 W.</p> <p style="text-align: center;"><math>20\text{ W (F1)} + 20\text{ W (F2)} = 40\text{ W}</math></p> <p><b>Test Duration:</b> Press this submenu key to set the length of time that the test port will deliver power after <b>Measurements</b> &gt; Test is pressed. Range for the test is 1 second to 1200 seconds. Use the <b>Arrow</b> keys or the number keypad. If you use the number keypad, then the Units menu of the Test Duration menu is displayed.</p> <p><b>Trace Mode</b> <b>Fast Low Noise:</b> Press this submenu key to change Trace Mode from the Fast setting to the Low Noise setting. Refer to <a href="#">Section 3-2 “Trace Mode” on page 3-2</a>.</p> <p><b>High Reflection Bypass:</b> When on it disables the auto shutoff when a high reflection event occurs.</p> <p><b>PIM Aid:</b> Press this submenu key to display the PIM Parameters dialog box (see <a href="#">Figure 3-5 on page 3-8</a>). This dialog box displays and allows editing of the current carrier frequencies and carrier power.</p>
---	--

**Figure 3-11.** Setup Menu for PIM vs. Time

### 3-11 Marker Menu

Key Sequence: **Marker**

Press the **Marker** main menu key to open the Marker menu. The instrument is equipped with six markers. Any or all markers can be employed simultaneously.

Marker	<b>Marker:</b> Press this submenu key to select which marker (1, 2, 3, 4, 5, 6) is active. The underlined marker number is the active marker. See <a href="#">Figure 3-13</a> .	
Marker <u>1</u> 2 3 4 5 6		
<u>On</u> Off		<b>On/Off:</b> Press this submenu key to turn On or Off the selected (underlined) marker in the <b>Marker</b> submenu key.
Delta On <u>Off</u>		
Marker to Peak		<b>Delta On Off:</b> Press this submenu key to turn on a delta marker and to prompt for a delta offset value, either positive or negative from the value of the currently active marker.
Marker to Valley		
All Markers Off	<b>Marker to Peak:</b> Press this submenu key to place the currently active marker on the highest signal amplitude that is currently displayed on screen. <b>Marker to Valley:</b> Press this submenu key to place the currently active marker on the lowest signal amplitude that is currently displayed on screen.	
	<b>All Markers Off:</b> Turns off all displayed markers.	

Figure 3-12. Marker Menu

Select Marker		
M1	M2	M3
M4	M5	M6

Figure 3-13. Marker Selection Box



# Chapter 4 — Noise Floor Measurements

## 4-1 Introduction

Noise Floor measurements test for receiver (Rx) interference sources that can affect a PIM measurement. In these measurements, transmit (Tx) power is Off, which allows you to check for external interference at the IM frequency being measured. The intermodulation distortion (IM) products of interest are in the same frequency range that is used by mobile equipment to communicate with the base station. Nearby mobiles can generate signals high enough to interfere with a PIM measurement.

The Noise Floor Time View measurement displays the signal level that is received by the MW82119B PIM Master at the IM product frequency as a function of time with TX<sub>1</sub> and TX<sub>2</sub> turned Off. The PIM Master is in PIM vs. Time analyzer mode during a Noise Floor - Time View measurement, but only the PIM Master receiver is being used. A typical noise floor Time View measurement is approximately -120 dBm, as shown in [Figure 4-1 on page 4-3](#). Refer to [Section 1-6 “Recommended PIM Testing Procedure” on page 1-6](#).

The Noise Floor Spectrum View measurement displays the signal level that is received by the MW82119B over the current Rx band. Because the Spectrum View sweeps across a range of frequencies, you are likely to see bands that are free of mobile traffic and bands with significant mobile traffic. Marker 2 will automatically be set to the current IM product frequency. Other markers can be activated to identify frequencies that are free of traffic. A typical Noise Floor - Spectrum View measurement is shown in [Figure 4-3 on page 4-5](#).

Anritsu recommends that you make a Noise Floor measurement before making a PIM measurement in order to rule out external interference. If external interference is present, change the TX<sub>1</sub>, TX<sub>2</sub>, or both test frequencies in order to move the IM product frequency into clear spectrum.

## 4-2 Noise Floor Measurement Setup

Before performing a Noise Floor measurement, the PIM Master must be calibrated. If you are performing a Noise Floor Time View calibration, refer to [“Calibrating the PIM Analyzer” on page 2-4](#)). If you are performing a Noise Floor Spectrum View measurement, a separate calibration is required. Press the **Start Cal Spectrum View** button in the Noise Floor menu, and then follow the on-screen instructions to calibrate the Spectrum View.

Setup is the same as the PIM vs. Time setup, which is described in [Chapter 3](#). If you have already set up the PIM Master for a PIM vs. Time measurement and performed a calibration, then skip to [Step 3](#).

1. Turn on the PIM Master.
2. Press the **Measurements** main menu key and then press the **PIM vs. TIME** submenu key.
3. Press the **Freq** main menu key.
4. Set the frequencies of Carrier F1 and Carrier F2.
5. Press the Intermod Order submenu key so that the desired intermodulation frequency order to be viewed is underlined. 3rd order is the most commonly chosen measurement .

<b>Note</b>	The PIM Parameters screen (press the PIM Aid submenu key) displays the IM frequencies. Output Power can be ignored for the Noise Floor measurement.
-------------	---

6. Press the **Setup** main menu key and then press the Test Duration submenu key to set a time from 1 second to 1200 seconds.
7. To set a limit, press the **Shift** and **Limit (6)** keys.
8. In the Limit menu, press the Limit key to choose Upper or Lower limit. You can then press the Set Default Limit submenu key or the Amplitude submenu key to set a limit value. Only the upper limit line has alarm and pass indicator functions.
9. Press the Limit Alarm submenu key to turn On the audible alarm.
10. Press the Pass Indicator submenu key to turn On the PASS / FAIL indication.
11. If necessary, calibrate the PIM Master. Refer to section [“Calibrating the PIM Analyzer” on page 2-4](#).

## 4-3 Performing the Noise Floor Test

1. Set up the Noise Floor measurement. See [“Noise Floor Measurement Setup” on page 4-2](#).
2. Connect the system under test to the test port connector of the PIM Master.
3. Press the **Measurements** main menu key and then press the Noise Floor submenu key.
4. Select either the Time View or Spectrum View measurement option.
5. Press the Test submenu key to begin the test.

While the test is in progress, the Test submenu key is highlighted in red. See [Figure 2-9 on page 2-19](#).

### 4-4 Noise Floor Time View Measurements

Noise Floor Time View measurement displays the signal level that is received by the PIM Master at the IM product frequency as a function of time with TX<sub>1</sub> and TX<sub>2</sub> turned Off.

The Noise Floor Measurement in Figure 4-1 shows no external interference. A good noise floor that will not interfere with a typical PIM test is below -120 dBm. After verifying that no interference is present, begin PIM testing. Note that units of dBc are not applicable to Noise Floor measurements.

#### Noise Floor Measurement with No External Interference

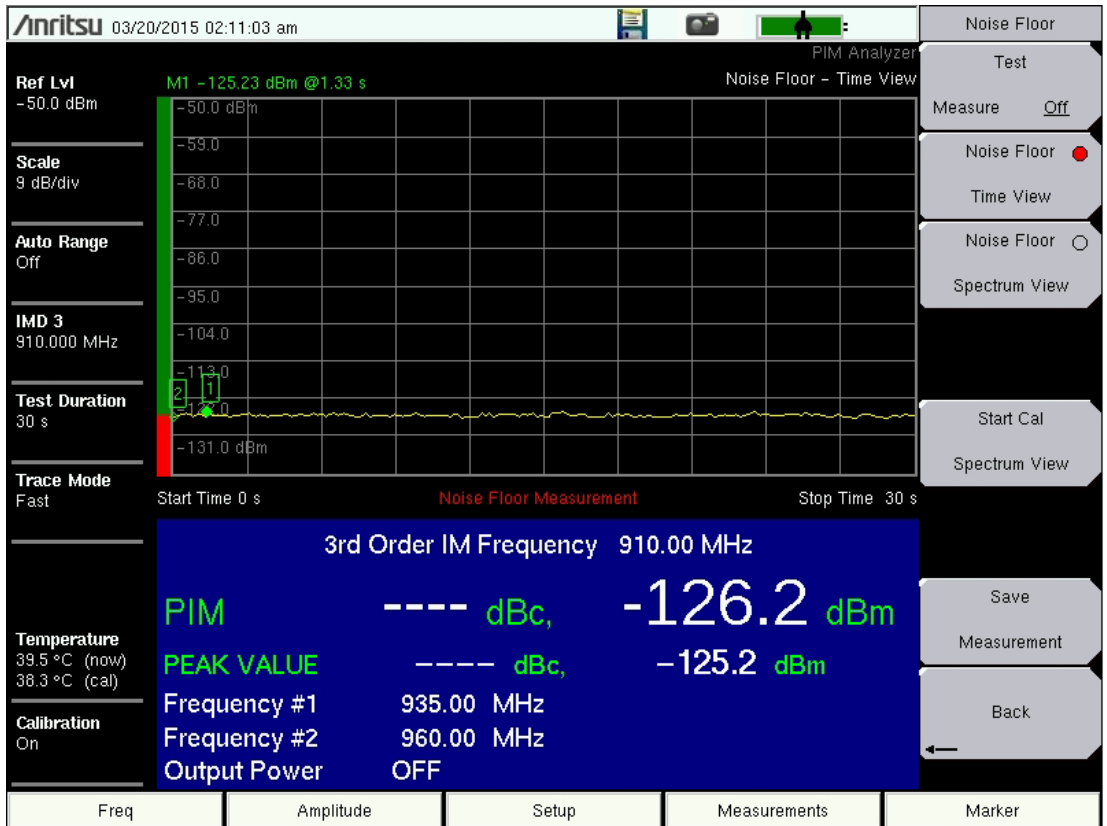

Figure 4-1. Typical Noise Floor (No External Interference, No Limit Line)

### External Interference Example

In the example shown in Figure 4-2, external interference is seen that is higher than the -97 dBm PIM test limit. This external signal level would be high enough to prevent an accurate PIM test. The test frequencies must be changed to find an IM product frequency without external interference (see Figure 4-3).

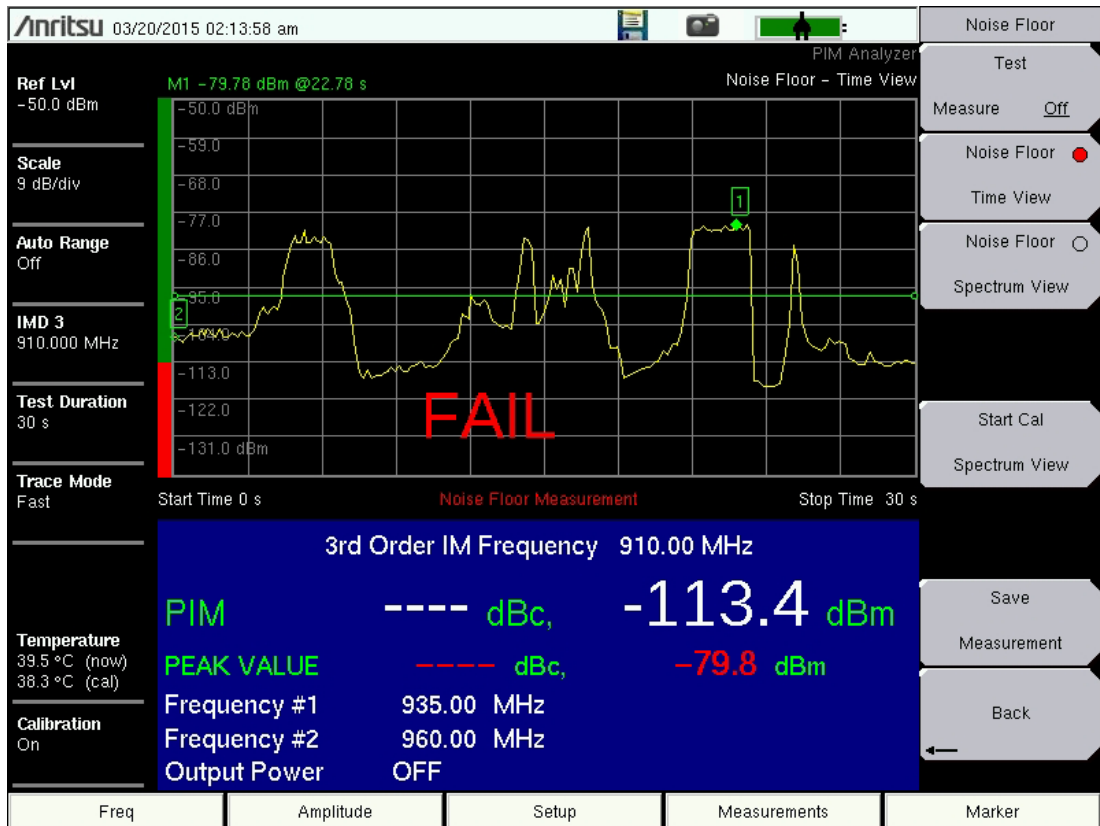

Figure 4-2. Noise Floor Measurement with External Interference

### 4-5 Noise Floor Spectrum View Measurement

Noise Floor Spectrum View Measurements displays the signal level that is received by the PIM Master over the current Rx band as a function of frequency with TX1 and TX2 turned Off. The Noise Floor Measurement in [Figure 4-3](#) shows no external interference high enough to impact the PIM test. Marker 2 shows the location of the current IM product test frequency.

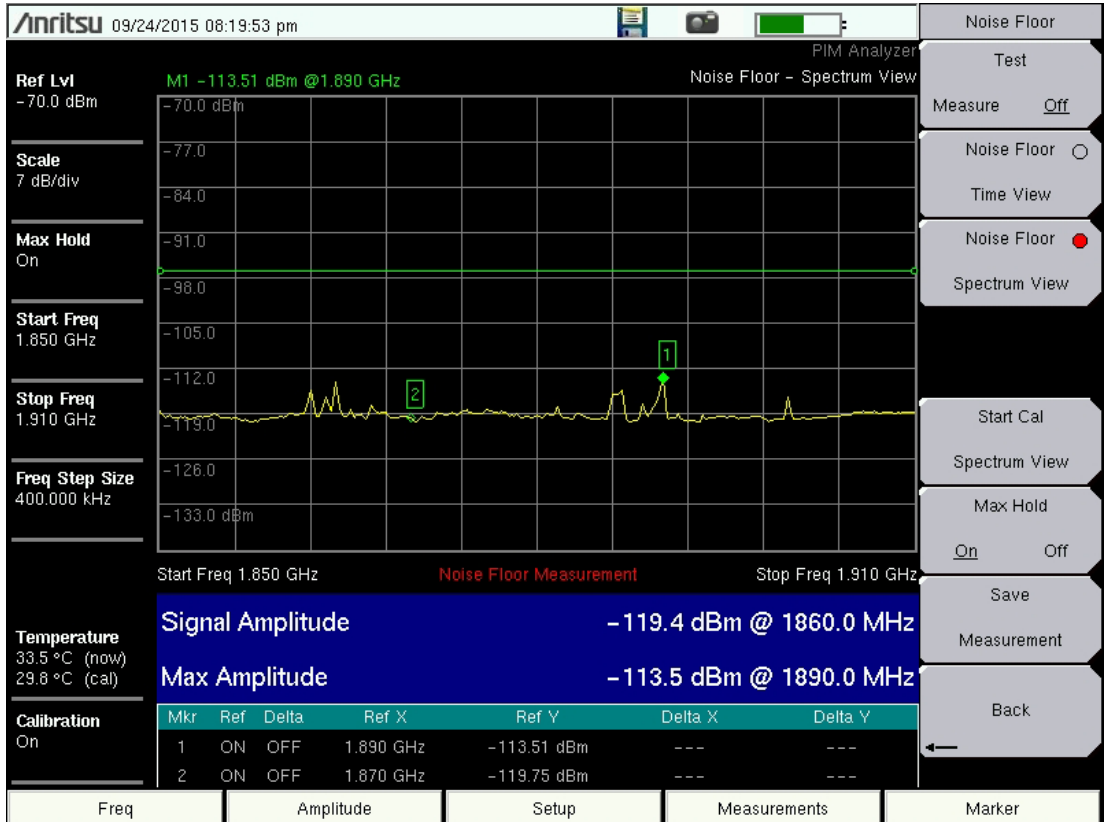

Figure 4-3. Typical Noise Floor Spectrum View Measurement

### 4-6 Saving a Noise Floor Measurement

To save a Noise Floor measurement, press **Shift** and **File (7)**, then press the **Save** or the **Save Measurement** submenu key.

## 4-7 Noise Floor Menu

Key Sequence: **Measurements** > Noise Floor

Noise Floor	<p><b>Test</b></p> <p><b>Measure Off:</b> Press this submenu key to start a Noise Floor measurement. When a measurement is being made, <b>Measure</b> is underlined on this submenu key, and the submenu key is highlighted in red color. The <b>RF-ON</b> light on the PIM Master is <b>Off</b> (no transmit power, receive only).</p> <p>In Noise Floor - Time View, the measurement will terminate when the test duration is completed (<b>Setup</b> &gt; Test Duration) or when the <b>Test</b> submenu key is pressed. When a test ends, <b>Off</b> is underlined. In Noise Floor Spectrum View, the measurement will continue until the <b>Test</b> submenu key is pressed.</p> <p><b>Noise Floor Time View:</b> Press this submenu key to measure the signal level that is entering the PIM Master at the IM product frequency.</p> <p><b>Noise Floor Spectrum View:</b> Press this submenu key to perform a swept measurement that shows the signal level that is entering the PIM Master over the current Rx band.</p> <p><b>Start Cal Spectrum View:</b> Press this submenu key to calibrate the Spectrum View. Follow the on-screen instructions.</p> <p><b>Max Hold:</b> Only visible when the Noise Floor - Spectrum View submenu key is selected. When <b>Off</b> is underlined, the trace will change during each sweep to show the current signal level for that sweep. When <b>On</b> is underlined, the trace level will only be updated if the new signal level is greater than the last signal level for each frequency.</p> <p><b>Save Measurement:</b> Press this submenu key to save a Noise Floor measurement.</p> <p><b>Back:</b> Press this submenu key to return to the <a href="#">“Measurements Menu” on page 2-18.</a></p>
Test	
Measure <span style="float: right;">Off</span>	
Noise Floor <span style="float: right;">●</span>	
Time View	
Noise Floor <span style="float: right;">○</span>	
Spectrum View	
~ ~ ~	
Start Cal	
Spectrum View	
Max Hold	
Save	
Measurement	
Back	
←	

**Figure 4-4.** Noise Floor Menu

### Measurements Menu

Refer to [“Measurements Menu” on page 2-18.](#)

# Chapter 5 — Distance-to-PIM (DTP)

## 5-1 Introduction – Distance-to-PIM (DTP) Analyzer

Distance-to-PIM (DTP) is similar to Distance-to-Fault (DTF), which Anritsu introduced in the Site Master in 1997 for identifying the location of impedance mismatches in a feed line. DTP quickly and accurately identifies the location of PIM faults inside the feed system as well as beyond the antenna. This capability eliminates the guesswork involved in isolating PIM sources and speeds site repairs.

The Anritsu PIM Master is capable of producing 80 Watts of RF power in the cellular communications bands. Users must take precautions to minimize exposure to these RF fields:

### Warning

Always terminate the PIM output port of the test equipment into a load, a loaded line, or a line that will radiate or absorb the energy before beginning a PIM test.

Confirm that the PIM Master RF power is off after a PIM test.

Always confirm that the PIM RF power is off before disconnecting a coaxial connection, otherwise RF burns may result. Immediate burns to fingers or eyes can result from exposure to live connectors.

Ensure that all antennas under test are placed so that no personnel are exposed to RF levels that exceed the maximum allowable exposure.

Distance-to-PIM is a swept measurement that enables identification of the location of multiple PIM sources in the RF path. It provides the ability to observe the impact of multiple PIM sources on the magnitude of the PIM signal. Distance-to-PIM is an analysis feature only, and it should not be used as a pass / fail test.

## 5-2 DTP Measurement

### F1 and F2 Carrier Sources

The default frequencies are selected by the Distance-to-PIM analyzer to optimize the distance resolution.

### Dmax and Data Points

Dmax is the maximum horizontal distance that can be analyzed. The Stop Distance setting cannot exceed Dmax. If the cable is longer than Dmax, then Dmax needs to be improved by increasing the number of data points. Note that the data points can be set to either 128 points or 255 points. For best results, Data Points should always be set to the maximum number of points available. You can choose 128 data points if measurement speed is critical.

### DTP Parameter Settings

When the DTP Parameters setup window is displayed, the DTP Aid menu is also displayed.

DTP Parameters can be set individually in the Distance and Setup menus or can conveniently be set in one location using the DTP Aid (DTP Parameters screen) from the Setup menu. The **Up** and **Left** arrow keys move the selection highlight up in the window. The **Down** and **Right** arrow keys move the selection highlight down in the window. The bottom selection is the Continue button.

When any parameter is highlighted, keying in a value and pressing the **Enter** key or a menu key completes the setting, and the selection highlight is incremented downward in the list. You can also press the **Esc** key to abort these settings and return to the Distance menu or the Setup menu, depending upon your starting point.

When numeric values are highlighted, the number keypad must be used to enter a value. An additional menu is displayed for distance, frequency, propagation velocity, or cable loss ((dB/ft or dB/m). Press the appropriate units submenu key or press the **Enter** key to set the value. The selection highlight is incremented to the next parameter (below) in the DTP Parameters setup window.

Additional selection menus are displayed when the following parameter buttons are highlighted in the DTP Parameters window:

- Data Points > [“Resolution Menu” on page 5-28](#)
- Cable > [“Cable Menu” on page 5-28](#)

The last item in the DTP Parameters setup window is the Continue button. Select this button and press the **Enter** key to close the DTP Parameters setup window and continue with your measurement. The menu display returns to either the Distance menu or the Setup menu, depending upon your starting point.

**Note**

Start and Stop distances can also be set in the Distance menu. Cable Loss, Propagation Velocity, and Cable specifications can also be set in the DTP Setup menu. Output Power can also be set in the Setup menu.



## 5-3 Post-Calibration Measurement

When necessary, calibrate the PIM Master. Refer to section “[Calibrating the PIM Analyzer](#)” on page 2-4.

A good practice is performing a DTP measurement after the calibration in order to verify that measurements appear normal after the calibration. [Figure 5-1](#) represents a typical Distance-to-PIM measurement of a PIM standard and a low PIM Load right after calibration.

**Distance: 0 ft to 100 ft**

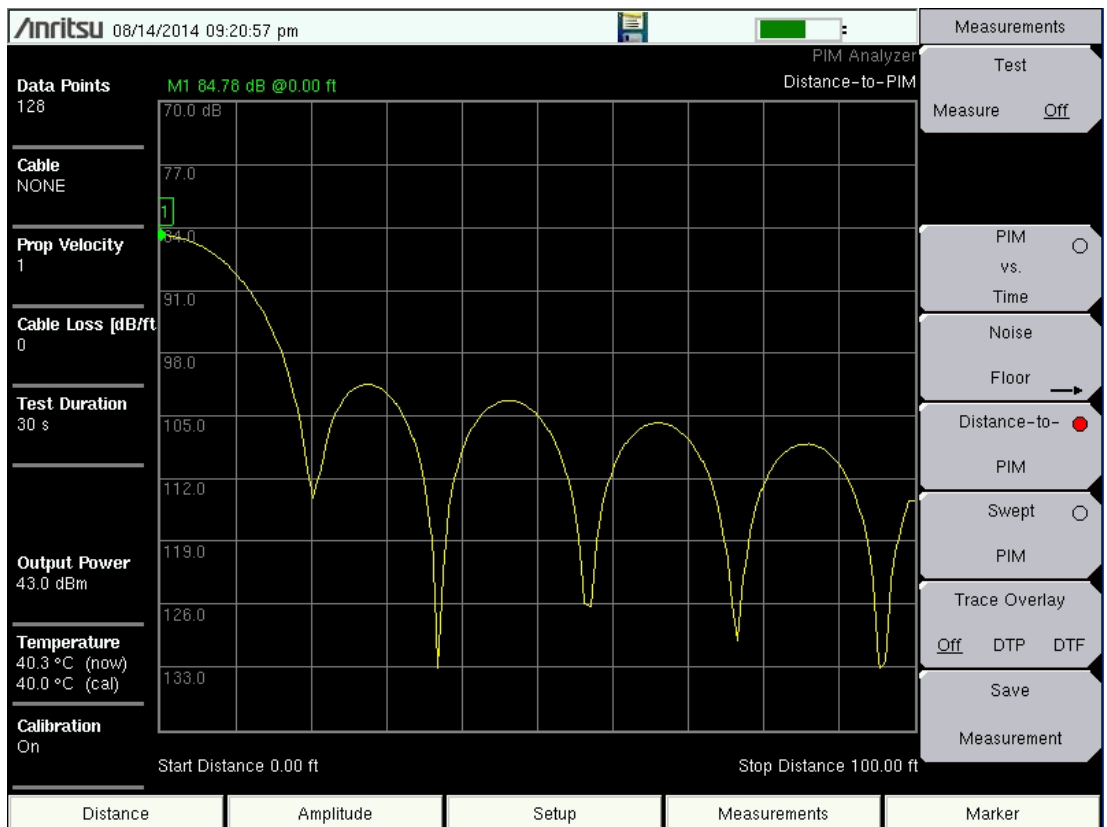

**Figure 5-1.** DTP Measurement of PIM Standard and Load after Calibration

## 5-4 DTP Measurement Setup

The main menu keys and submenu keys for Distance-to-PIM analysis differ from the PIM versus Time menus as described in [Chapter 3, “PIM versus Time”](#). For a description of the key functions in the Distance-to-PIM menus, refer to section “[Menu Map 1](#)” on page 5-14.

1. Press the **Measurements** main menu key to display the Measurements menu.
2. Press the Distance-to-PIM submenu key.
3. Press the **Distance** main menu key.

### Note

The DTP Analyzer includes several menus with buttons for setting up measurement parameters. All of these parameter settings are also available in one convenient location in the DTP Parameters window, which is opened by pressing the DTP Aid submenu key.

4. Press the DTP Aid submenu key to set up the DTP measurement parameters. The DTP Parameters setup window is displayed, and the DTP Aid menu is displayed.

The screenshot displays the 'DTP Parameters' configuration screen. The top status bar shows 'Anritsu 11/09/2012 04:42:25 pm'. The main area contains the following parameters and their values:

Parameter	Value	Additional Info
Start Distance (ft):	0.00	
Stop Distance (ft):	30.00	(Dmax = 1111.09ft)
Data Points:	128	
Cable:	NONE	
Propagation Velocity:	0.800	
Cable Loss (dB/ft):	0.000	
Output Power (dBm):	43.0	

A 'Continue' button is located at the bottom center. On the right side, the 'DTP Aid' menu is open, showing 'Units', 'Start', 'Calibration', and 'Back' options. The bottom navigation bar includes 'Distance', 'Amplitude', 'Setup', 'Measurements', and 'Marker'.

**Figure 5-2.** DTP Parameters

5. From the DTP Aid menu, press the Units submenu key to display the Units submenu. Press the Meters or Feet submenu key to select the desired units to be used in the measurement. The menu display returns to the DTP Aid menu.

6. Highlight one of the distance values. Use the number keypad to set the Start and Stop distances.

The Stop Distance needs to be smaller than Dmax. Dmax is the maximum horizontal distance that can be analyzed, and it is displayed next to the Stop Distance value. Because the Stop Distance cannot exceed Dmax, if the cable is longer than Dmax, then Dmax needs to be improved by increasing the number of data points. Dmax is also affected by the cable propagation velocity.

Note that the number of data points can be set to either 128 points or 255 points. The number of data points should always be set to the maximum amount of steps available, with respect to the F2 swept bandwidth. When the start and stop distances have been set, the menu display returns to the DTP Aid menu.

7. Highlight (or touch) the Data Points button to open the Resolution menu. Select the number of data points that best fits the measurement: 128 points or 255 points.
8. Highlight (or touch) the Cable button to display the available cable specifications. Use the Cable List submenu keys along with the **Arrow** keys to navigate to the desired cable specification, and then press **Enter** (or press the **Esc** key to abort without selecting a cable).

<b>Note</b>	When a cable is selected from this list, propagation velocity and cable loss are automatically set by the instrument.
-------------	---

9. If the Cable selection is “None”, then, for the cable in use, enter an applicable Propagation Velocity. Entering a Cable Loss value is optional because this variable is not currently used by the PIM Master software for PIM fault distance analysis.
10. Highlight (or touch) the Output Power button to set an appropriate power level and press **Enter**.
11. Press the Continue button. If changes have been made to parameters that affect calibration, then a Calibration OFF indication will appear on the screen. Proceed to [“Calibrating the PIM Analyzer” on page 2-4](#) to initiate a calibration prior to performing a DTP analysis. Otherwise, continue at [Step 12](#).

If you press the **Back** submenu key from the Calibration menu, then the display returns to the Distance menu (or to the menu that was being displayed before you began calibration).

12. Press the **More** submenu key to open the DTP Setup menu. **More** is found in the Distance menu. After pressing **More**, the DTP Setup menu is displayed, allowing you to get cable parameters or to set windowing.
13. Press the **Window** submenu key to open the Windowing menu. Select the desired windowing format by pressing one of the four submenu keys: Rectangular, Nominal Side Lobe, Low Side Lobe, or Minimum Side Lobe. Refer to [Appendix B, “Windowing”](#).

14. Press the **Measurements** main menu key. Then press the **Test** submenu key to begin your measurement.

**Caution** Make sure that you have attached a test lead to the instrument and that it is attached to the system under test before pressing the test button.

If you need to terminate the measurement before the allotted Test Duration time is complete, then you can press the **Test** submenu key to turn off the measurement.

For additional actions, refer to [Section 5-5 “Making a DTP Measurement” on page 5-7](#).

## 5-5 Making a DTP Measurement

1. Connect the DUT to the test port of the PIM Master.
2. Press the **Measurements** main menu key to display the Measurements menu.
3. Press the **Test** submenu key so that **On** is underlined and the **Test** submenu key is outlined in Red. **Testing begins.**
4. Save the current measurement by pressing the **Save Measurement** submenu key. The **Save Measurement** dialog box opens.
5. Type a name for the measurement to be saved and press **Enter**.

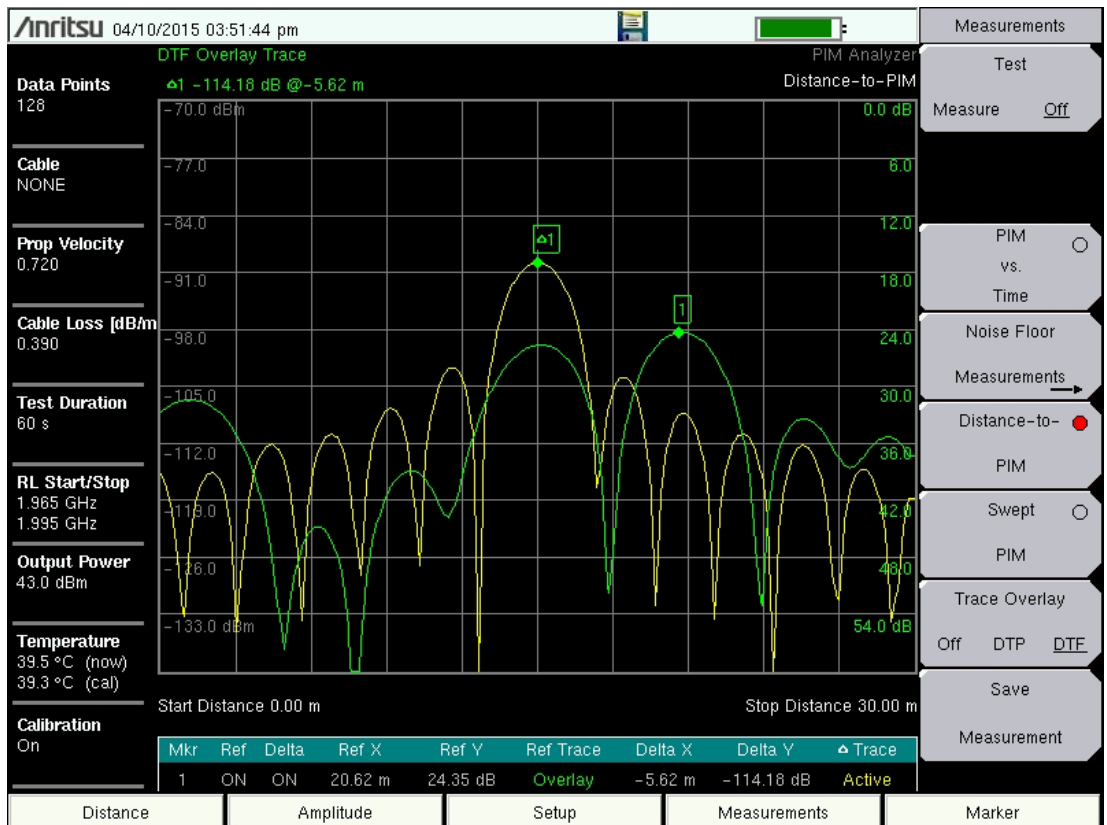

**Figure 5-3.** DTP Measurement Example

As shown in [Figure 5-3](#), the Distance-to-PIM trace (yellow trace with peak near 15 m) and Distance-to-Fault trace (green trace with peak near 21 m) are both automatically measured and presented when a DTP measurement is made. Distance-to-Fault (DTF) acts like a map to identify RF connector locations in the system. In this example, the two traces indicate that the PIM problem is located at the first connector past the input.

Up to six markers can be placed at points of interest on the DTF and DTP traces, and the marker table will display the signal parameters at each marker point. After each measurement, Marker 1 is always placed at the peak value of the DTF measurement, and Delta Marker 1 is always placed at the peak of the DTP measurement.

## 5-6 Trace Overlay

Trace Overlay is a feature allowing comparison in the field between a Distance-to-PIM trace that is active and a Distance-to-PIM or Distance-to-Fault trace that is saved in memory (an overlay trace). This is useful for determining (at a site) the distance between an unknown PIM source and a known PIM source or reflection.

### DTP/DTP Overlay

To determine if a PIM source is beyond the antenna or inside the feed system, you need to know exactly where the antenna radiating surface is located. This can be determined by placing a bag of steel wool on an antenna radome and performing a Distance-to-PIM measurement. The resulting peak in the measurement marks the location of the antenna radiating surface. Place this trace into memory (overlay trace), and then measure Distance-to-PIM again with the steel wool removed. This new active trace shows the distance to the actual PIM sources at the site. The distance between the peak of the active trace (site PIM) and the overlay trace (PIM marker) shows how far in front of the antenna the PIM source is located if the distance value is positive. If the distance value is negative, then the unknown PIM source is before the antenna, inside the feed system. Refer to [Chapter 6](#).

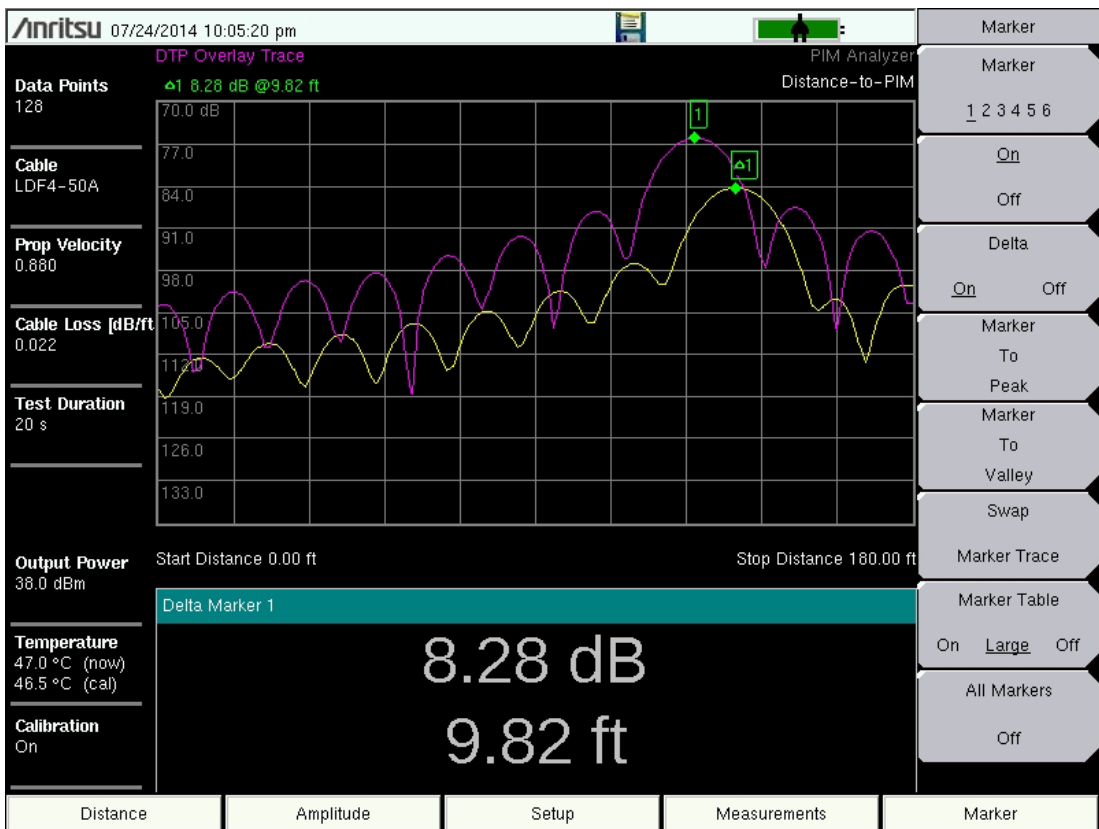

Figure 5-4. DTP/DTP Trace Overlay Example – PIM Source 10 Ft from End of Cable

## DTP/DTF Overlay (Manual Method)

Comparing the PIM location to known reflections on the line is also useful for troubleshooting PIM locations. Before beginning PIM measurements, the cable system sweep tests should already have been performed. Often, operators require a system DTF measurement and a cable length measurement (DTF with a short circuit at the end of the cable) as part of the close-out package. If these measurements were made using a PIM Master with Option 331, then these measurements are available in memory for future overlays.

Use the Trace function to select the desired DTF trace (refer to [Chapter 6](#)). Using the Trace Overlay submenu key, select DTF. The selected DTF trace appears on the screen along with the active Distance-to-PIM trace (site PIM). A delta marker is automatically generated and shows the relative distance between the DTF peak and the DTP peak.

The example in [Figure 5-5](#) shows an active Distance-to-PIM measurement (site PIM) with a Cable Length DTF trace. The DTF trace accurately identifies the end of the cable. In this case, the PIM source is 18.65 ft beyond the end of the cable, indicating that the site PIM is likely beyond the antenna.

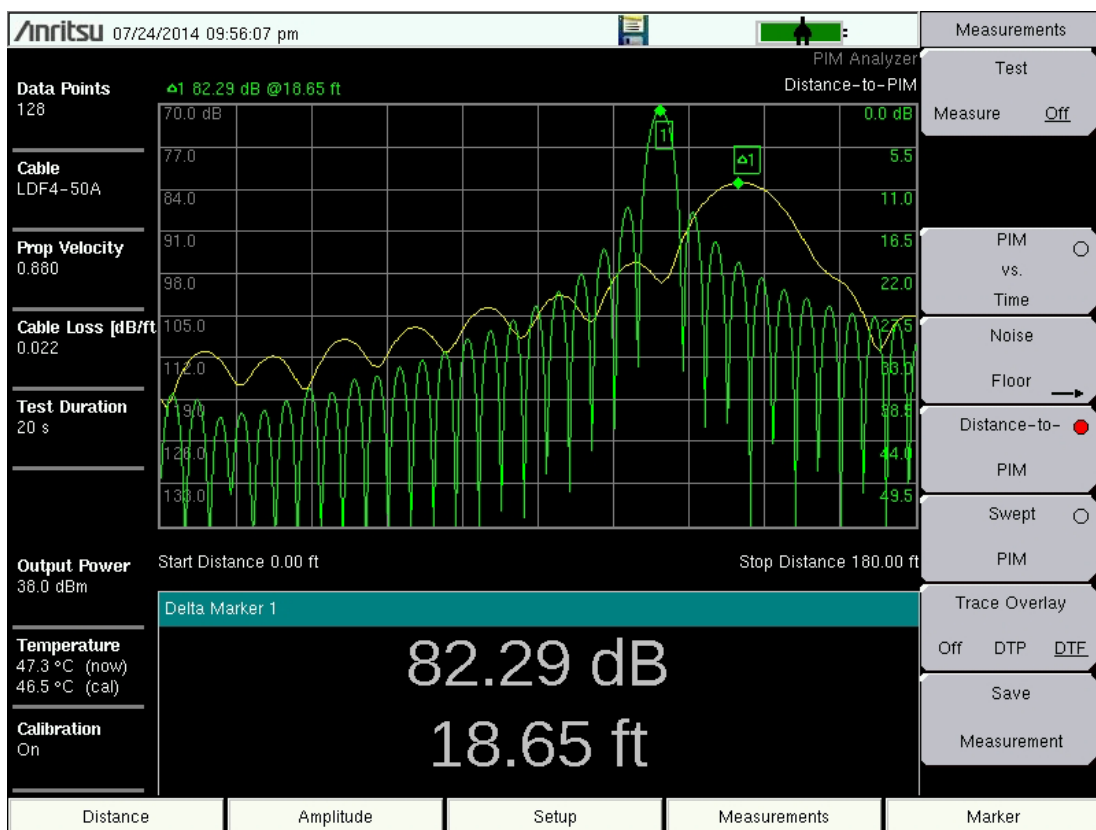

**Figure 5-5.** DTP/DTF Trace Overlay Example – PIM Source Beyond End of Cable

### DTP/DTF Overlay (Automatic Method)

In cases where high resolution DTF traces are not available to import, low resolution DTF traces can be generated through the PIM test port. By default, Distance-to-PIM measurements have this low resolution DTF measurement turned on. If not desired, then the automatic DTF overlay can be turned off in the Setup menu.

DTF measurements made through the PIM test port have limited swept frequency range due to filters inside the PIM analyzer. Each PIM analyzer has a different internal filter, resulting in different swept frequency ranges for each model number. As a result, the DTF resolution is different for each PIM Master model. For short measurement distances, an imported DTF measurement may be preferred in order to distinguish closely spaced connections. For longer measurement distances, the automatic DTF overlay is usually sufficient.

Figure 5-6 shows an example of an automatic DTP/DTF overlay made at 900 MHz in a distributed antenna system (DAS), where the length of the system was more than 140 m. As can be seen, the DTF resolution in this case is sufficient to identify splitters and antenna locations along the DAS branch. The PIM locations can be compared to these known reflections to help isolate PIM faults in the sector. The red bars seen here are the DTP enhanced resolution feature described in Section 5-7 on page 5-12.

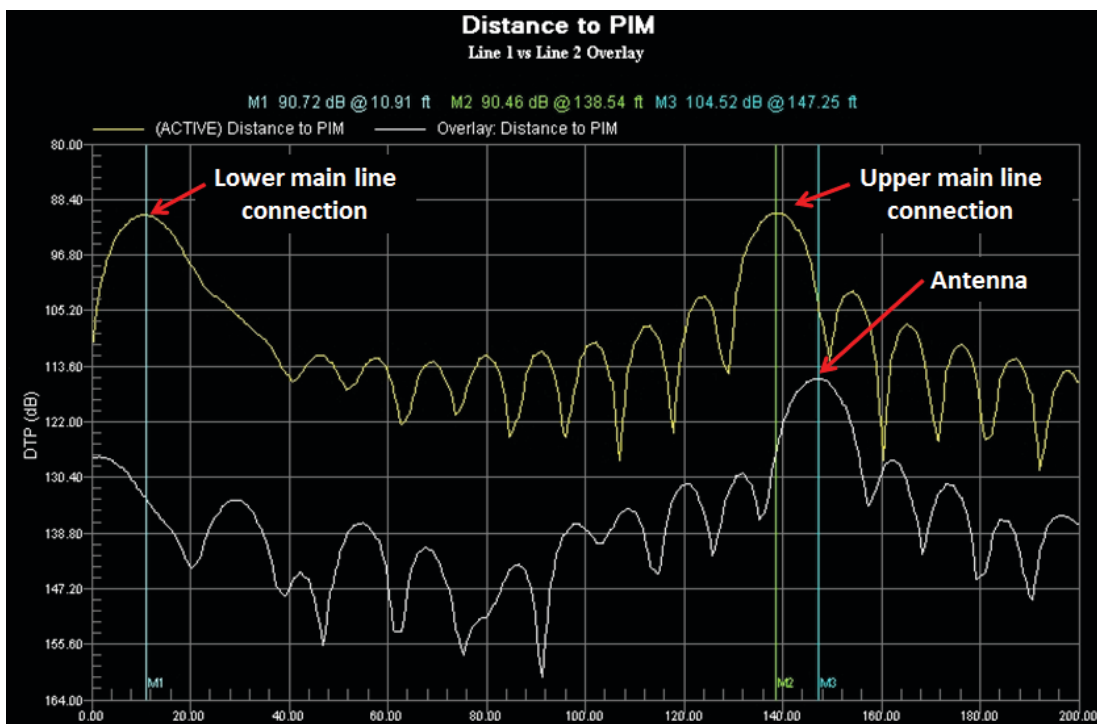

Figure 5-6. DTP/DTF Trace Overlay Example



## Overlay Using Line Sweep Tools Software

After you leave the site, Anritsu Line Sweep Tools (LST) also provides a method to overlay multiple DTP results. [Figure 5-7](#) shows an overlay of two DTP measurements from the main receive path and the diversity receive path of a sector. One line has very good PIM performance, but the other line needs repair. Using the good line (lower trace) as a reference, you can clearly see that the PIM problems on the bad line are 11 feet away from the radio at the main line connection and 9 feet behind the antenna at the top (also at a main line connection). LST also could be used to report site improvements by creating an overlay of saved measurements that are taken before and after repairs.



**Figure 5-7.** Distance-to-PIM Overlay of Sector Main and Diversity Paths

## 5-7 Enhanced Resolution

When making Distance-to-PIM measurements, the ability to individually resolve two PIM sources that are physically close together is determined by the swept bandwidth of the IM (intermodulation product) product being measured. The more IM product frequency bandwidth available, the closer together two PIM sources can be resolved. [Table 5-1](#) shows the calculated resolution for several of the MW82119B frequency bands, assuming a propagation velocity factor of 0.88. As can be seen in the table, some frequency bands have inherently better resolution than others.

**Table 5-1.** Typical Calculated Resolution of Sample Frequency Bands<sup>a</sup>

Frequency Band	Standard Resolution
850 MHz	5.5 m (18.0 ft)
900 MHz	5.3 m (17.3 ft)
1800 MHz	2.4 m ( 7.9 ft)
1900 MHz	3.3 m (10.8 ft)

a. With propagation velocity factor of 0.88

The Enhanced Resolution feature typically improves the standard resolution by a factor of two during Distance-to-PIM measurements. This feature is enabled by default (refer to [Figure 5-20 on page 5-25](#)). In Enhanced Resolution mode, the location of PIM sources on the line is estimated, and up to 4 impulse bars are displayed. The impulse bars mark the predicted location of the measured PIM sources. The vertical impulse bars are easy to read, and they clearly identify the location of multiple PIM sources (when they exist). See [Figure 5-8 on page 5-13](#).

An error checking function is employed to compare the magnitude of the enhanced resolution prediction to the magnitude of the standard resolution prediction. If correlation between the two estimates is not good, then the impulse bars are not displayed.

Occasionally, false PIM locations will be predicted by the enhanced resolution algorithm. False predictions are more likely to occur when measuring an unstable PIM source (magnitude changing versus time), when measuring very low magnitude PIM signals, or when testing in a noisy RF environment. Even with the occasional false prediction, this technology can help operators find and eliminate PIM sources more quickly in the field.

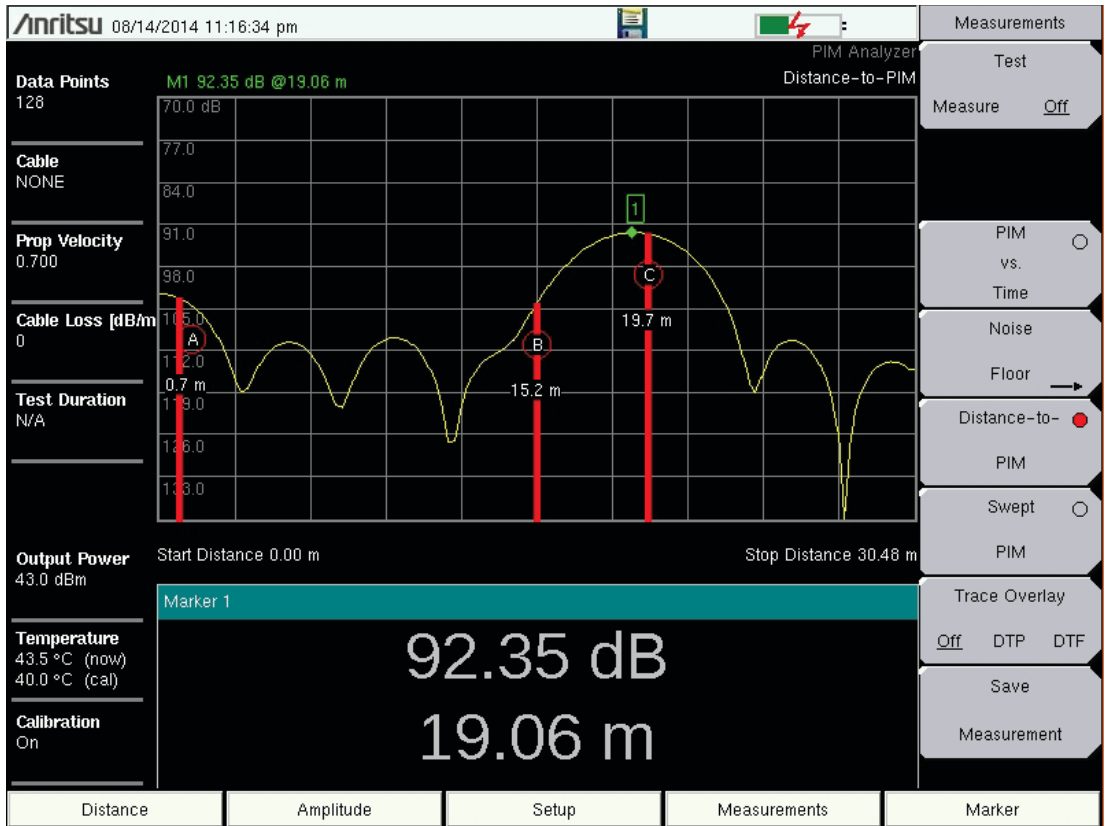

Figure 5-8. Example of Impulse Bars with Enhanced Resolution

## 5-8 Menu Map 1

Figure 5-9 shows a map of the Distance-to-PIM Analyzer mode menus. Menu maps typically display all possible submenu keys, although some keys are displayed on the instruments only under special circumstances (refer to menu descriptions on the following pages). The following sections describe main menus and associated submenus.

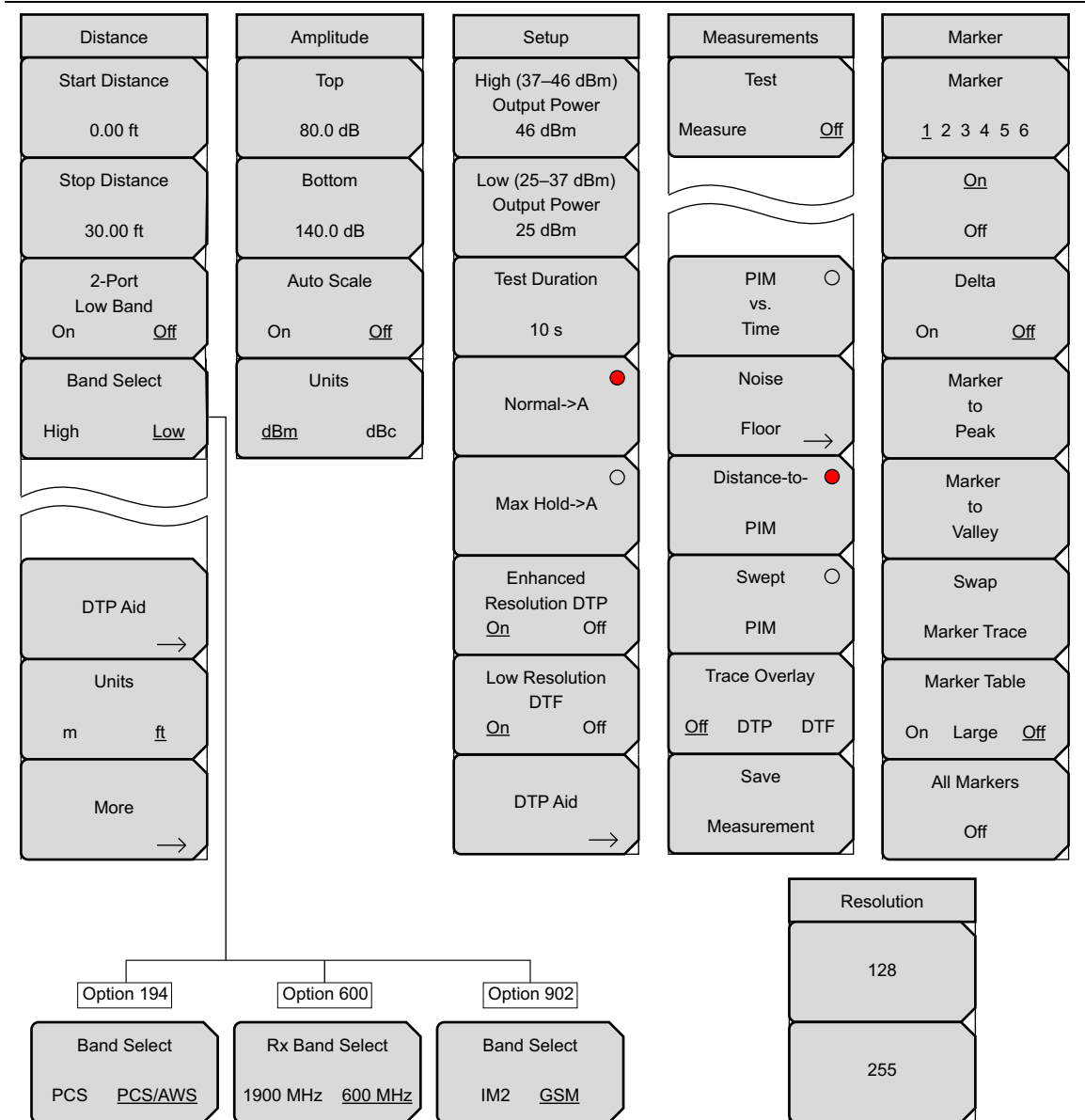

Figure 5-9. DTP Analyzer Menu Map 1

## 5-9 Menu Map 2

Figure 5-10 shows a map of the supplemental menus for the Distance-to-PIM Analyzer mode.

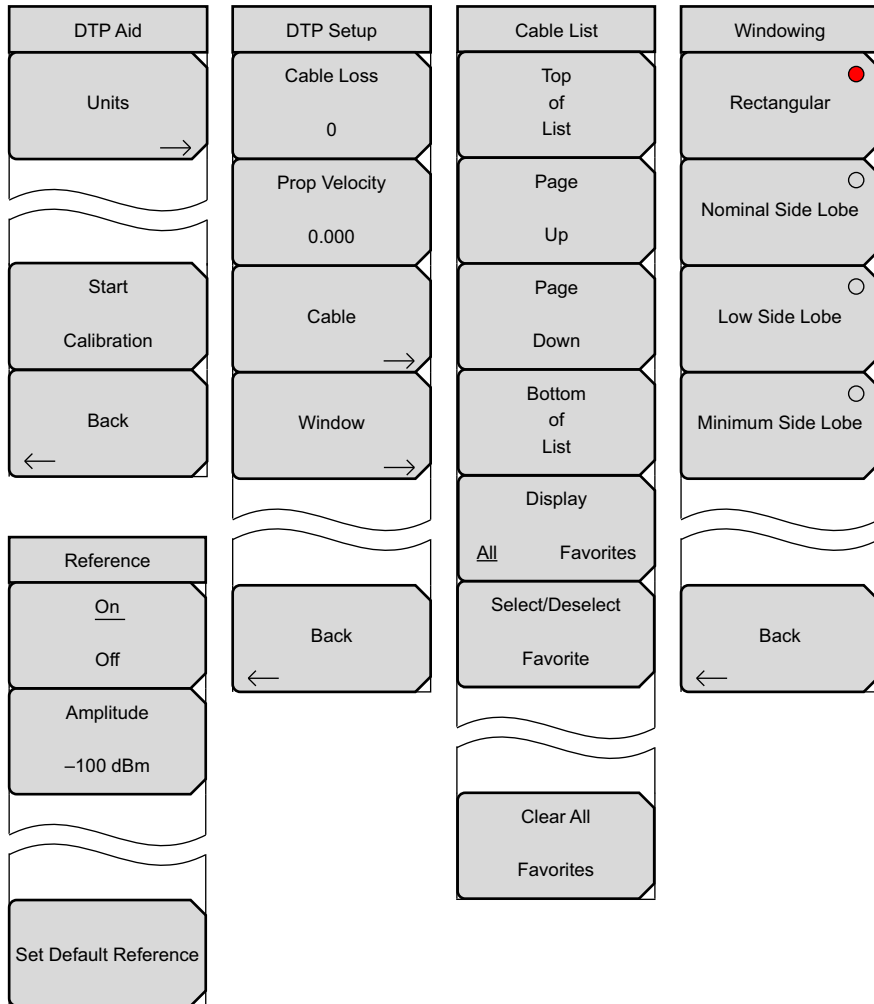

Figure 5-10. DTP Analyzer Menu Map 2

## 5-10 Distance Menu

Key Sequence: **Distance**

Distance	<b>Start Distance:</b> Press the <b>Distance</b> main menu key followed by the Start Distance submenu key and enter the desired length in feet by using the keypad or the <b>Arrow</b> keys. The maximum Start Distance setting is equal to the Stop Distance setting.
Start Distance 0.00 ft	
Stop Distance 30.00 ft	<b>Stop Distance:</b> Press this submenu key to set the desired length in feet by using the keypad or the <b>Arrow</b> keys. The minimum Stop Distance setting is equal to or greater than the Start Distance setting. Refer to the Dmax value reported in the DTP Parameters window. Dmax is influenced by factors such as the number of data points and the propagation velocity of the cable. Refer to <a href="#">Step 6 in Section 5-4 "DTP Measurement Setup" on page 5-4.</a>
2-Port Low Band On <u>Off</u>	<b>Note:</b> The Start Distance and Stop Distance can be the same, but neither setting can override the other. Change settings in an order that avoids any overlap. The <b>Up/Down</b> arrow keys change the distance settings by 1 ft increments, and the <b>Left/Right</b> arrow keys change the distance settings by 0.1 ft increments. With the number keypad, you can set distances by 0.01 ft increments (or by 0.01 m increments). If the settings include a digit other than zero in the second decimal position, then the <b>Up/Down</b> arrow keys cannot change a value if that change would exceed a limit. Use the <b>Left/Right</b> arrow keys or the number keypad to increase or decrease the remaining value.
Band Select High <u>Low</u>	<b>2-Port Low Band:</b> Selects the 2-Port mode when On and hides the Band Select key from view.
<hr/>	
DTP Aid →	<b>DTP Aid:</b> Press this submenu key to open the DTP Parameters window and the DTP Aid submenu to set up the test parameters for DTP testing.
Units m <u>ft</u>	<b>Units:</b> Press this submenu key to toggle the units setting between meters and feet. The selection is underlined.
More →	<b>More:</b> Press this submenu key to open the DTP Setup menu.
<hr/>	
Option 194	
Band Select PCS <u>PCS/AWS</u>	<b>DTP Aid:</b> Press this submenu key to open the DTP Parameters window and the DTP Aid submenu to set up the test parameters for DTP testing.
<hr/>	
Option 600	
Rx Band Select 1900 MHz <u>600 MHz</u>	<b>Units:</b> Press this submenu key to toggle the units setting between meters and feet. The selection is underlined.
<hr/>	
Option 902	
Band Select IM2 <u>GSM</u>	

**Figure 5-11.** Distance Menu

**Distance Menu Settings**

Start Distance and Stop Distance settings can also be initiated by highlighting their values in the DTP Parameters window. Refer to [Figure 5-2 on page 5-4](#).

<b>Note</b>	The left-most main menu key is labeled <b>Freq</b> in the PIM vs. Time and the Swept PIM measurement settings. It is labeled <b>Distance</b> in the Distance-to-PIM measurement setting.
-------------	--

## 5-11 DTP Aid Menu

Key Sequence: **Distance** > DTP Aid

or

Key Sequence: **Setup** > DTP Aid

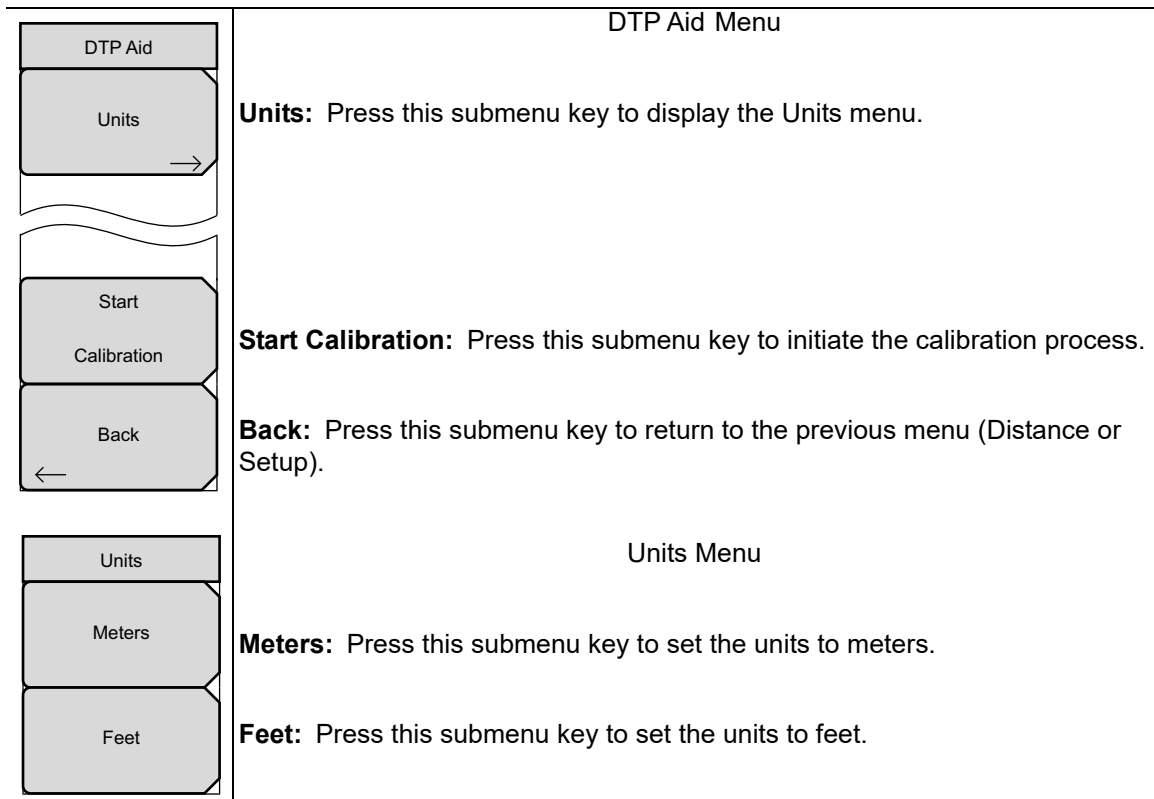

**Figure 5-12.** DTP Aid Menu



## 5-12 DTP Setup Menu

Key Sequence: **Distance** > More

DTP Setup	
Cable Loss 0	<b>Cable Loss:</b> Press this submenu key to enter the loss in dB/ft or dB/m for the selected cable by using the keypad or the <b>Arrow</b> keys, and then press <b>Enter</b> .
Prop Velocity 0.000	<b>Prop Velocity:</b> Press this submenu key to enter the applicable propagation velocity for the selected cable by using the keypad or the <b>Arrow</b> keys, and then press <b>Enter</b> .
Cable →	<b>Cable:</b> Press this submenu key to open a list of available cable specifications (see <a href="#">Figure 5-16 on page 5-21</a> ). Using the <b>Arrow</b> keys or the touch screen, select the desired cable and then press <b>Enter</b> .
Window →	If a cable is selected from this list, then the cable loss and propagation velocity are set automatically, and you do not need to set those values with the other submenu keys.
	<b>Window:</b> Press this submenu key to open the Windowing menu. The options are: Rectangular, Nominal Side Lobe, Low Side Lobe, and Minimum Side Lobe. Refer to <a href="#">Appendix B, "Windowing"</a> for more information.
Back ←	<b>Back:</b> Press this submenu key to return to the Distance menu.

**Figure 5-13.** DTP Setup Menu

Settings for Cable Loss, Propagation Velocity, and the Cable list box can also be initiated by highlighting their values in the DTP Parameters window. See [Figure 5-2 on page 5-4](#).

## 5-13 Cable List Menu

Key Sequence: **Distance** > More > Cable

or

Touch **Cable** in the DTP Parameters window:

**Distance** > DTP Aid > Cable

**Setup** > DTP Aid > Cable

The Cable List Box and the Cable List menu are displayed simultaneously (see Cable List in [Figure 5-16 on page 5-21](#)). Select a Cable in the list box and then press the **Enter** key to use those cable loss and propagation velocity values in your measurement. Press the **Esc** key to return to the Distance menu without making a selection.

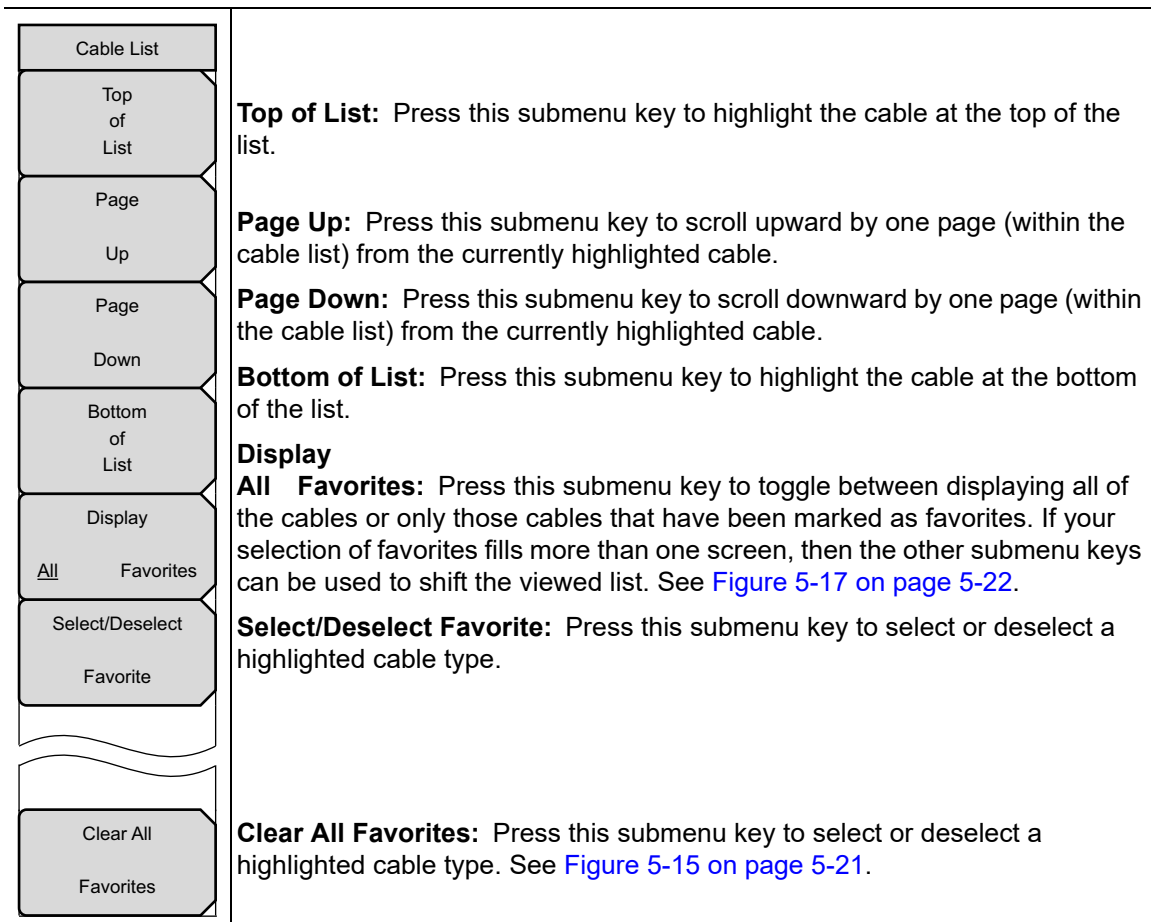
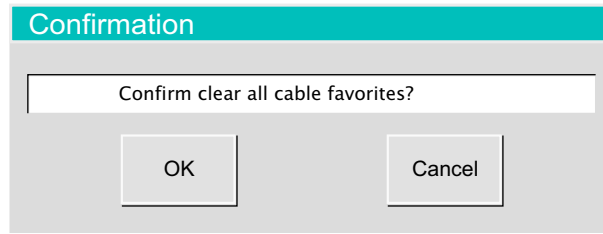

**Figure 5-14.** Cable List Menu

You can add cables to the list, remove cables, and modify cable specifications by using Line Sweep Tools.

## Confirmation Clear All Favorites

Key Sequence: **Distance** > More > Cable > Clear All Favorites



**Figure 5-15.** Clear All Favorites Confirmation Message

## Cable List

Key Sequence: **Distance** > More > Cable

Cable Name	[ Prop Vel	, (F1	, CL1(dB/m)	(F2	, CL2(dB/m)	(F3	, CL3(dB/m) ]]
NONE	[ 1.000,	( 1000	, 0.000)	( 2000	, 0.000)	( 2500	, 0.000)
FSJ1-50A (6 GHz)	[ 0.840,	( 1000	, 0.196)	( 2500	, 0.322)	( 6000	, 0.527)
FSJ2-50 (6 GHz)	[ 0.830,	( 1000	, 0.133)	( 2500	, 0.223)	( 6000	, 0.374)
FSJ4-50B (6 GHz)	[ 0.810,	( 1000	, 0.118)	( 2500	, 0.201)	( 6000	, 0.344)
EFX2-50 (6 GHz)	[ 0.850,	( 1000	, 0.121)	( 2500	, 0.202)	( 6000	, 0.341)
LDF1-50 (6 GHz)	[ 0.860,	( 1000	, 0.136)	( 2000	, 0.200)	( 6000	, 0.377)
LDF2-50 (6 GHz)	[ 0.880,	( 1000	, 0.115)	( 2000	, 0.170)	( 6000	, 0.323)
LDF4-50A (6 GHz)	[ 0.880,	( 1000	, 0.073)	( 2500	, 0.121)	( 6000	, 0.200)
HJ4-50 (6 GHz)_	[ 0.914,	( 1000	, 0.092)	( 2500	, 0.156)	( 6000	, 0.257)
HJ4.5-50 (6 GHz)	[ 0.920,	( 1000	, 0.054)	( 2500	, 0.089)	( 6000	, 0.148)
310801_____	[ 0.821,	( 1000	, 0.115)	( 1000	, 0.115)	( 1000	, 0.115)
311201_____	[ 0.820,	( 1000	, 0.180)	( 1000	, 0.180)	( 1000	, 0.180)
311501_____	[ 0.800,	( 1000	, 0.230)	( 1000	, 0.230)	( 1000	, 0.230)
311601_____	[ 0.800,	( 1000	, 0.262)	( 1000	, 0.262)	( 1000	, 0.262)
311901_____	[ 0.800,	( 1000	, 0.377)	( 1000	, 0.377)	( 1000	, 0.377)
352001_____	[ 0.800,	( 1000	, 0.377)	( 1000	, 0.377)	( 1000	, 0.377)
AVA5-50 7/8__	[ 0.910,	( 1000	, 0.038)	( 2000	, 0.055)	( 2500	, 0.063)
AVA7-50 1-5/8__	[ 0.920,	( 1000	, 0.022)	( 2000	, 0.034)	( 2500	, 0.038)
CR50 540PE____	[ 0.880,	( 1000	, 0.069)	( 2000	, 0.103)	( 2500	, 0.116)
CR50 1070PE____	[ 0.880,	( 1000	, 0.037)	( 2000	, 0.055)	( 2500	, 0.064)

**Figure 5-16.** Cable List Box, Table of Specifications

## Favorites (in Cable List)

Key Sequence: **Distance** > More > Cable > Display

Press Display, if necessary, until Favorites is underlined in the submenu key.

Cable Name	[ Prop Vel , ( F1 , CL1(dB/m) ) ( F2 , CL2(dB/m) ) ( F3 , CL3(dB/m) ) ]
* LDF4-50A (6 GHz	[ 0.880, ( 1000 , 0.073) ( 2500 , 0.121) ( 6000 , 0.200)]
* AVA5-50 7/8_____	[ 0.910, ( 1000 , 0.038) ( 2000 , 0.055) ( 2500 , 0.063)]
* AVA7-50 1-5/8__	[ 0.920, ( 1000 , 0.022) ( 2000 , 0.034) ( 2500 , 0.038)]
* LMR400_____	[ 0.850, ( 1000 , 0.135) ( 2000 , 0.196) ( 2500 , 0.222)]
* RF1 5/8-50GHF__	[ 0.880, ( 1000 , 0.024) ( 2000 , 0.036) ( 2500 , 0.042)]
* RF2 1/4-50_____	[ 0.880, ( 1000 , 0.021) ( 2000 , 0.032) ( 2500 , 0.041)]
* LCF78-50JA_____	[ 0.900, ( 1000 , 0.039) ( 2000 , 0.058) ( 2500 , 0.066)]
* AR158J50_____	[ 0.910, ( 1000 , 0.026) ( 2000 , 0.042) ( 2500 , 0.052)]
* AT114FX50_____	[ 0.910, ( 1000 , 0.029) ( 2000 , 0.044) ( 2500 , 0.052)]
* AT158FX50_____	[ 0.910, ( 1000 , 0.022) ( 2000 , 0.033) ( 2500 , 0.039)]

Figure 5-17. Cable List Box Showing Favorites

## 5-14 Windowing Menu

For a description of these windowing features, refer to [Appendix B, “Windowing”](#).

Key Sequence: **Distance** > More > Window

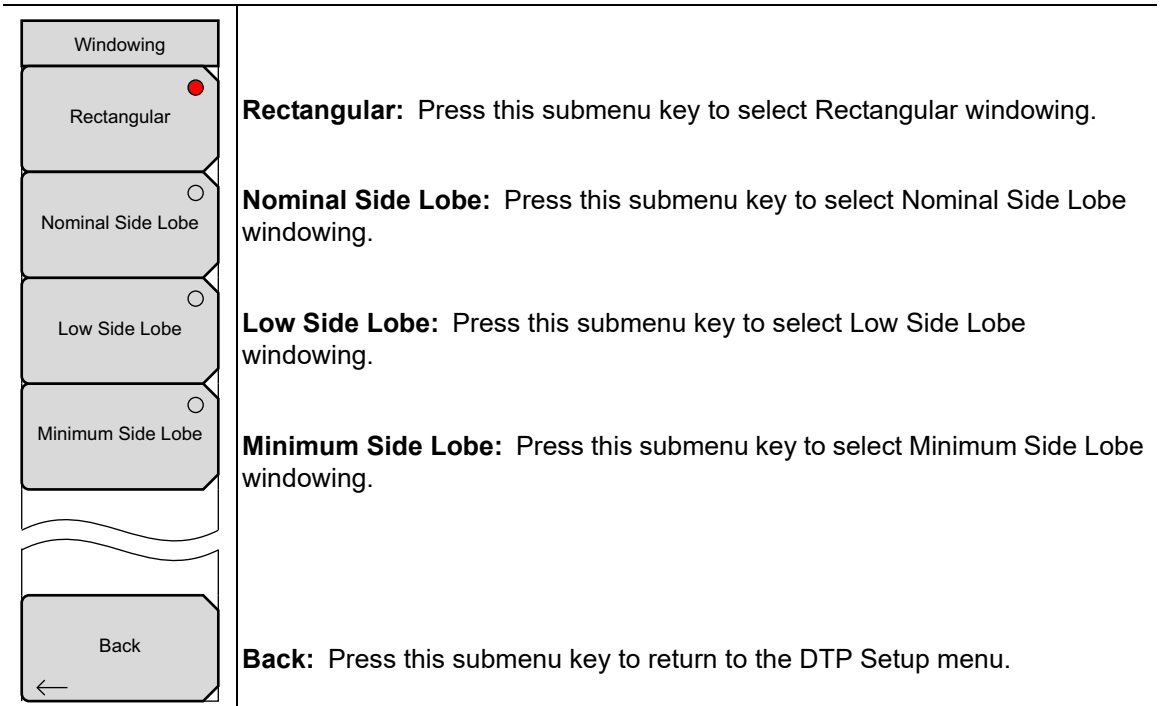

**Figure 5-18.** DTP Windowing Menu

## 5-15 DTP Amplitude Menu

Key Sequence: **Amplitude**

Amplitude	<b>Top:</b> Press this submenu key to set the top amplitude value. 0.0 dB is the upper limit.
Top 80.0 dB	<b>Bottom:</b> Press this submenu key to set the bottom amplitude value. 260 dB is the lower limit.
Bottom 140.0 dB	<b>Auto Scale:</b> Press this submenu key to toggle Auto Scale On or Off.
Auto Scale On      Off	<b>Units</b> <b>dBm dBc:</b> Toggles the measurement display units between dBm and dBc. The amplitude for upper and lower limits automatically adjusts to the equivalent level for the selected units.
Units dBm      dBc	

**Figure 5-19.** DTP Amplitude Menu

## 5-16 Setup Menu

Key Sequence: **Setup**

Setup	
High (37–46 dBm) Output Power 46 dBm	<b>High (37–46 dBm) Output Power:</b> Press this submenu key to set the output power level within the higher range for both carrier frequencies, F1 and F2.
Low (25–37 dBm) Output Power 25 dBm	<b>Low (20–37 dBm) Output Power:</b> Press this submenu key to set the output power level within the lower range for both carrier frequencies, F1 and F2.
Test Duration 10 s	<b>Note:</b> Power output value from the test port is twice the set output value. For example, when <b>Setup</b> > Output Power is set to 20 W, total output power is 40 W. $20\text{ W (F1)} + 20\text{ W (F2)} = 40\text{ W}$
~	
High Reflection Bypass On Off	<b>Test Duration:</b> Press this submenu key to set the length of time that the test port will deliver power after Test is pressed. Range for the test is 1 second to 1200 seconds. Use the <b>Arrow</b> keys or the number keypad. If you use the number keypad, then the “Units Menu” on page 5-26 is displayed.
Enhanced Resolution DTP On Off	<b>Note:</b> When Enhanced Resolution is <b>On</b> , Test Duration does not apply, and <b>N/A</b> is displayed. Refer to the Enhanced Resolution submenu key description.
Low Resolution DTF On Off	<b>High Reflection Bypass:</b> When on it disables the auto shutoff when a high reflection event occurs.
DTP Aid →	<b>Enhanced Resolution DTP</b> <b>On Off:</b> Press this submenu key to toggle Enhanced Resolution On and Off. The default setting is <b>On</b> . Use this feature to resolve PIM sources that are physically close together. Up to 4 vertical impulse bars in the sweep window mark the predicted distance location of the measured PM sources.

When **On**, DTP measurements are conducted one time only, then the measurement stops, and the results are displayed.

**Low Resolution DTF**  
**On Off:** Press this submenu key to toggle On and Off Distance-to-Fault measurements through the PIM test port. The default setting is **On**.

**DTP Aid:** Press this submenu key to display [Figure 5-2, “DTP Parameters” on page 5-4](#) and the DTP Aid menu.

**Figure 5-20.** DTP Setup Menu

The Output Power setting can also be initiated by highlighting its value in the DTP Parameters window. Refer to [Figure 5-2 on page 5-4](#).

## 5-17 Units Menu

This menu is displayed when the **Test Duration** submenu key is pressed followed by the use of the number keypad to enter a number of seconds for the desired test duration. The **Test Duration** submenu key is in the **Setup** menu.

Key Sequence: **Setup > Numerals** (from number keypad)

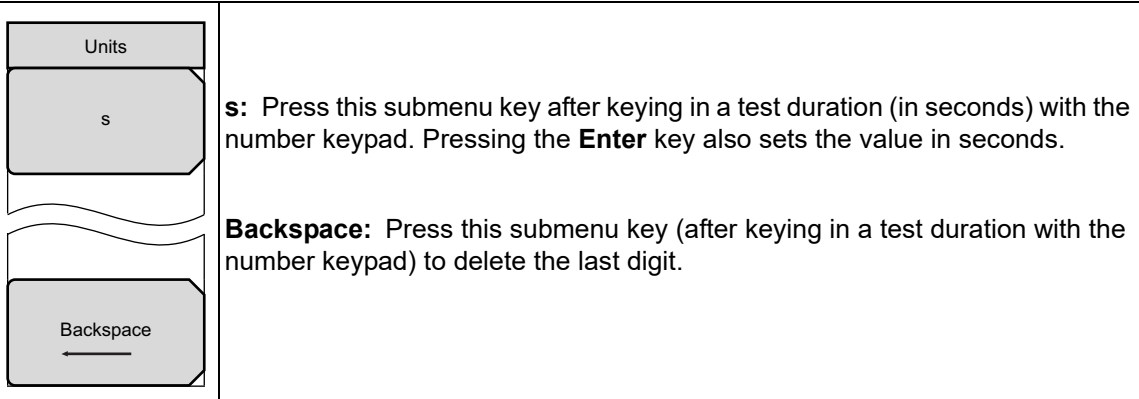

**Figure 5-21.** DTP Test Duration (Units) Menu

## 5-18 Measurements Menu

Refer to [“Measurements Menu” on page 2-18.](#)



## 5-19 Marker Menu

Key Sequence: **Marker**

Press the **Marker** main menu key to open the Marker menu. The instrument is equipped with six markers. Any or all markers can be employed simultaneously.

Marker	<b>Marker:</b> Press this submenu key to select which marker (1, 2, 3, 4, 5, 6) is active. The underlined marker number is the active marker. See <a href="#">Figure 5-23</a> .
Marker <u>1</u> 2 3 4 5 6	<b>On/Off:</b> Press this submenu key to turn On or Off the selected (underlined) marker in the <b>Marker</b> submenu key.
On Off	
Delta	<b>Delta</b>
On <u>Off</u>	<b>On Off:</b> Press this submenu key to turn on a delta marker and to prompt for a delta offset frequency, either positive or negative from the frequency of the currently active marker.
Marker to Peak	<b>Marker to Peak:</b> Press this submenu key to place the currently active marker on the highest signal amplitude that is currently displayed on screen.
Marker to Valley	<b>Marker to Valley:</b> Press this submenu key to place the currently active marker on the lowest signal amplitude that is currently displayed on screen.
Swap Marker Trace	<b>Swap Marker Trace:</b> Press this submenu key to move markers from one trace to another (when Trace Overlay is On). See <a href="#">Figure 6-4 on page 6-5</a> .
Marker Table	<b>Marker Table</b>
On   Large <u>Off</u>	<b>On Large Off:</b> Press this submenu key to toggle the marker table On, Off, or on and Large. The Large marker display shows only the x-axis and y-axis values of the active marker.
All Markers Off	<b>All Markers Off:</b> Turns off all displayed markers.

**Figure 5-22.** Marker Menu

Select Marker		
M1	M2	M3
M4	M5	M6

**Figure 5-23.** Marker Selection Box

## 5-20 Resolution Menu

This menu is displayed when the Data Points button is highlighted in the DTP Parameters window (Figure 5-2 on page 5-4).

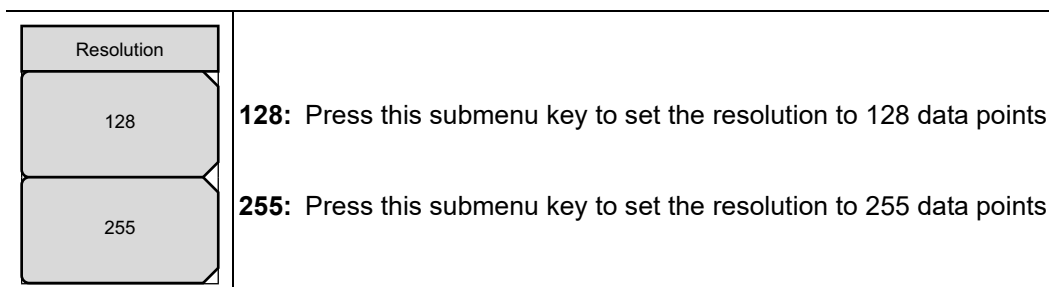

Figure 5-24. DTP Resolution Menu

## 5-21 Cable Menu

This menu is displayed when the Cable button in the DTP Parameters window is highlighted (by using the **Arrow** keys). See Figure 5-26.

Key Sequence: **Distance** > DTP Aid > **Arrow Key**

Key Sequence: **Setup** > DTP Aid > **Arrow Key**

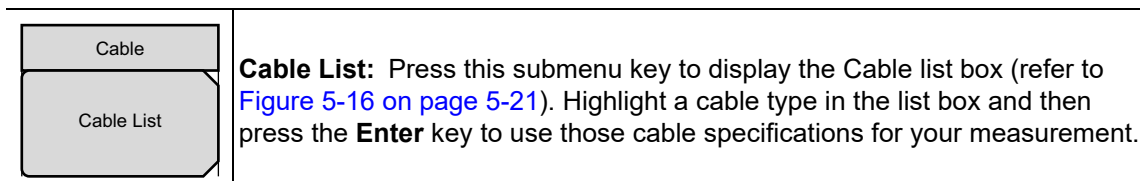

Figure 5-25. DTP Cable Menu

## DTP Parameters Window

Cable edit box selected via **Arrow** keys

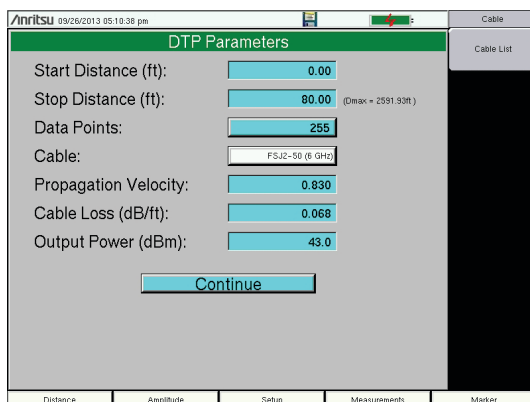
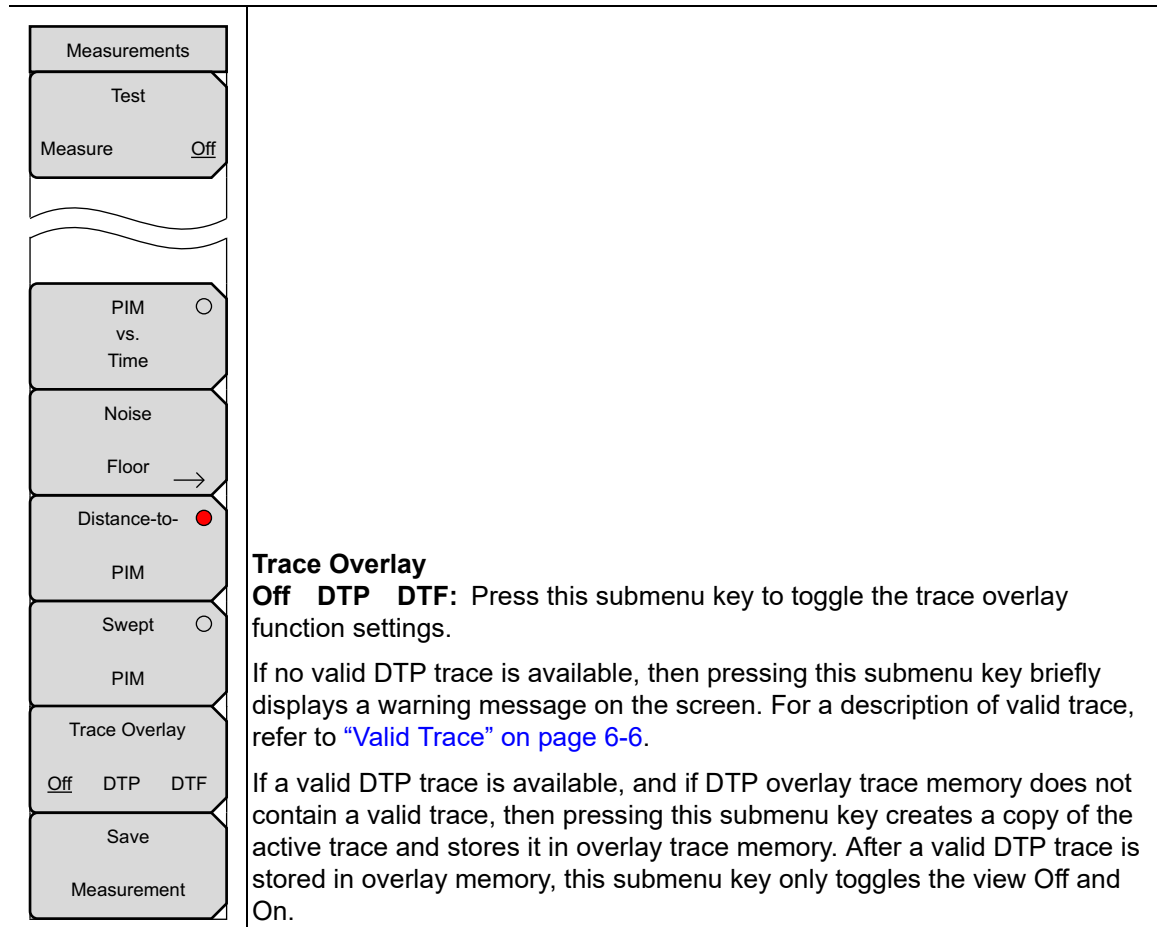

Figure 5-26. Cable List Submenu Key

## 5-22 Trace Submenu Key

For the complete Measurements menu description, refer to [“Measurements Menu” on page 2-18](#). For the Trace menu description, refer to [“Trace Menu, Distance-to-PIM” on page 6-5](#). The Measurements menu Trace Overlay submenu key is described here:



**Figure 5-27.** Trace Menu – Distance-to-PIM

## 5-23 Reference (Limit) Menu

When measurement type is Distance-to-PIM:

Key Sequence: **Shift > Limit (6)** key

A reference limit is available for Distance-to-PIM measurements to place a visual reference line on the screen for evaluating PIM magnitudes. This line is for reference only and cannot be used for PASS/FAIL indication.

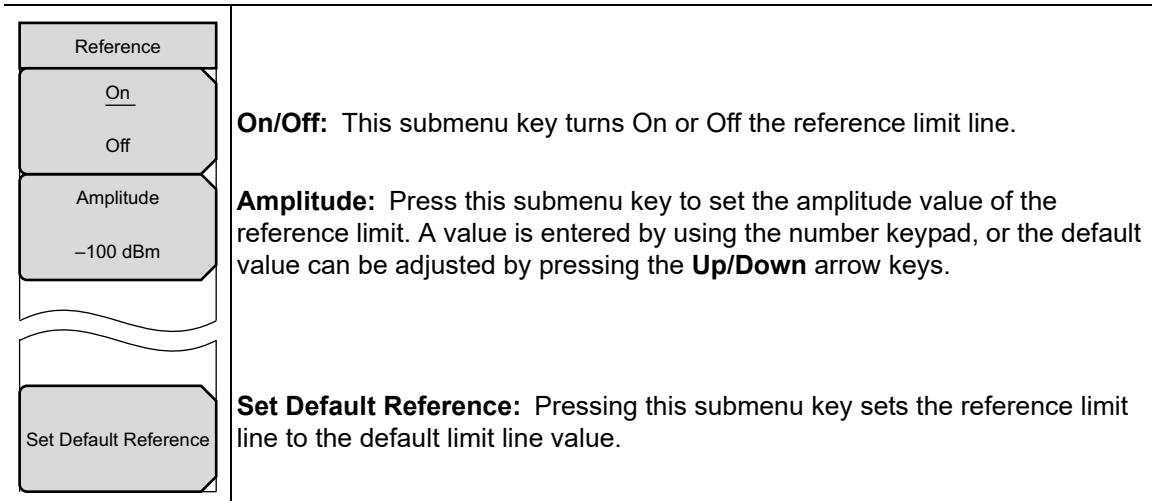

**Figure 5-28.** Reference (Limit) Menu

# Chapter 6 — Trace

## 6-1 Introduction

The Trace menu is available only in Distance-to-PIM (DTP) measurement mode and in the Noise Floor Spectrum - View mode. For DTP measurements, the PIM Master can display two different traces simultaneously in the sweep window. The active trace is the current measurement. The overlay trace is the trace of a previous DTP or DTF measurement that is stored in memory. This capability is particularly useful for identifying the location of an unknown PIM source relative to a known PIM marker or reflection placed in the system.

## 6-2 DTP/DTP Trace Overlay

Perform a Distance-to-PIM measurement with a known PIM marker in place. Remove that PIM marker and perform the same measurement again. Then compare measurement traces to determine a PIM location.

### DTP/DTP Trace Overlay Example

1. Set your PIM Master measurement type to Distance-to-PIM by pressing **Measurements** > Distance-to-PIM.
2. Set up DTP measurement parameters.
3. Press **Measurements** > Test.
4. When the measurement is completed, press **Shift** then **Trace (5)**.
5. In the Trace menu (see [Figure 6-4 on page 6-5](#)), press Copy Active Trace to Overlay. When an active trace is copied to overlay, the Trace Overlay submenu key is automatically toggled to On (if not already On).

See [Figure 6-1 on page 6-2](#) for an example of DTP/DTP Trace Overlay.

When the trace has been copied to overlay, the trace color immediately changes to the color that has been set in the Select Color choice box (see [Figure 6-5 on page 6-6](#)).

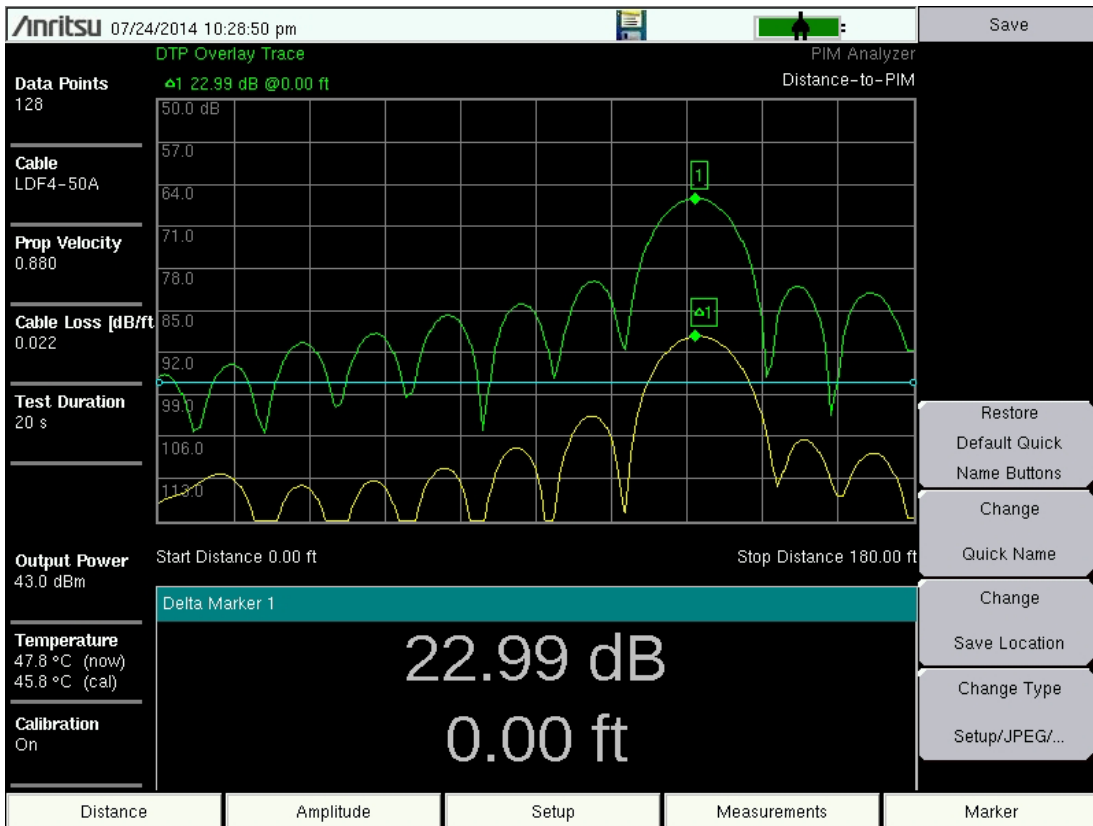

Figure 6-1. DTP/DTP Trace Overlay Example

6. Press **Select Trace Color**, if desired, to set a specific color for the overlay trace.
7. Set up for the next measurement. Press **Measurements > Test**.

The active trace is displayed along with the stored trace, and markers are automatically placed on the peaks. The marker table displays the relative distance between peaks. Refer to [Section 5-19 “Marker Menu” on page 5-27](#) and the marker menu for additional information. To view the table, toggle the Marker Table submenu key to On or to Large.

**Note** Trace Overlay can be toggled On and Off from the Trace menu or from the Measurements menu. Refer to [Section 5-22 “Trace Submenu Key” on page 5-29](#) and [Section 6-4 “Trace Menu, Distance-to-PIM” on page 6-5](#).

## 6-3 DTP/DTF Trace Overlay

Perform the normal DTF measurements required on a line. If Option 331 is installed, then these files will be in instrument memory and will be available to overlay onto subsequent Distance-to-PIM measurements. DTF traces provide useful information, such as the exact length of the line and the location of RF connectors on the line.

### DTP/DTF Trace Overlay Example

1. Press **Shift** then **Trace (5)**.
2. In the Trace menu, press Load DTF Trace. The displayed Recall menu allows you to select any saved DTF trace to load into memory.
3. Set the PIM Master measurement type to Distance-to-PIM by pressing **Measurements** > Distance-to-PIM.
4. Press Test.

In [Figure 6-2](#), the DTF trace selected was DTF-RL, with a precision load installed at the end of the line. This measurement is conducted to reveal the Return Loss level of each of the RF connections in the line. Due to the higher resolution available with DTF traces, each RF connector in the line is clearly visible. In this case, the highest PIM source is clearly coming from the middle RF connector.

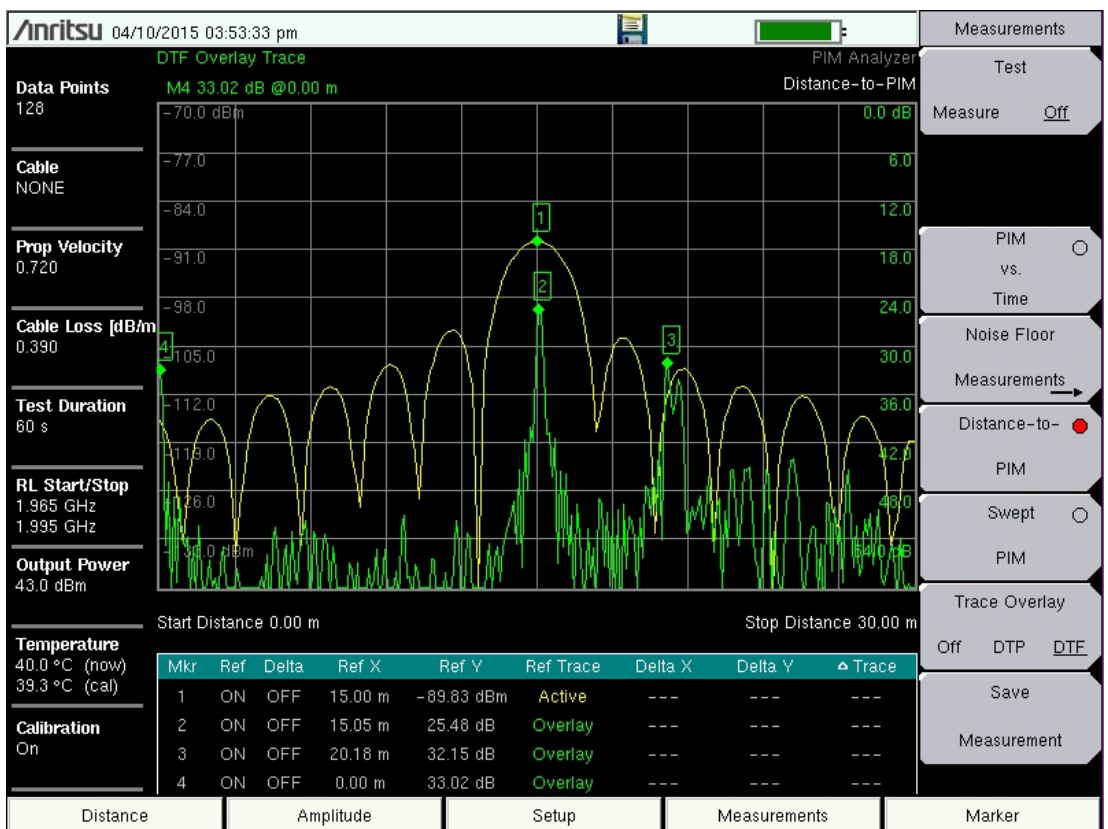

**Figure 6-2.** High resolution DTF Measurement Overlaid with DTP Measurement

### Automatic DTP/DTF Trace Overlay

Figure 6-3 shows the same measurement as Figure 6-2, but Figure 6-3 was made by using the automatic DTP/DTF overlay function. Both measurements identify the RF connector locations, but the reduced resolution here (due to the filter inside the PIM test instrument) is evident over this short test length.

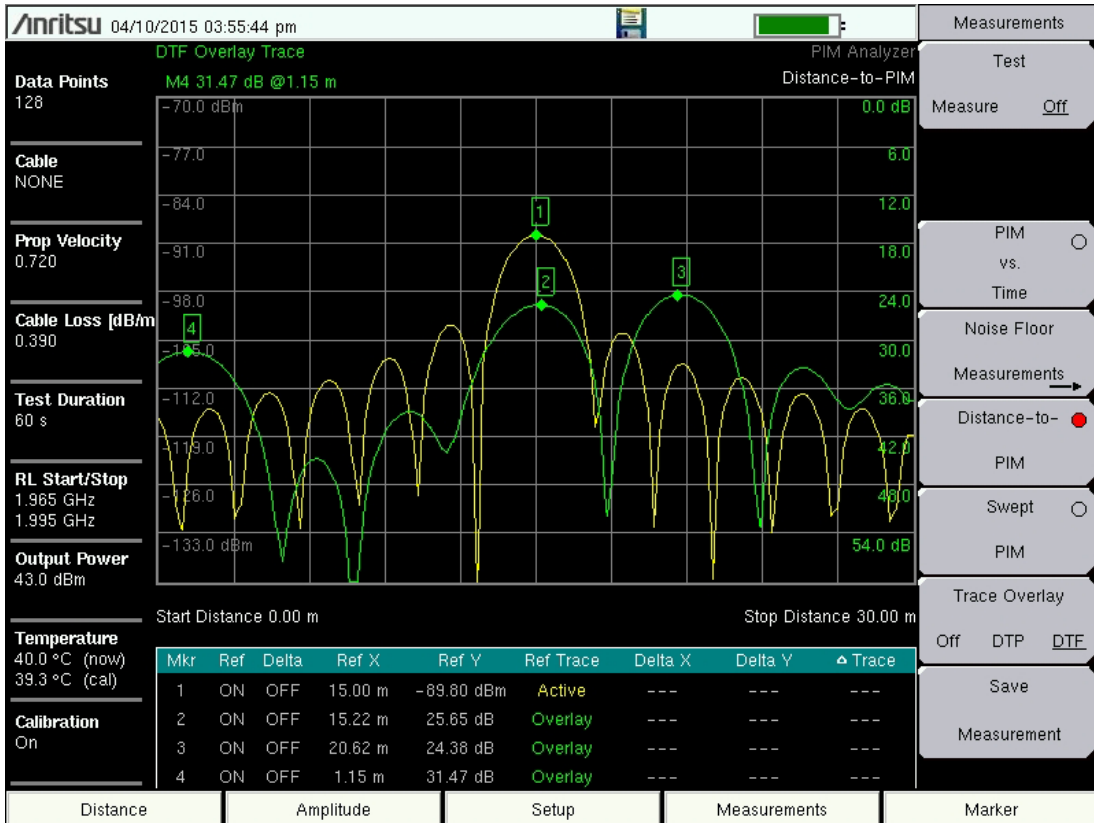

Figure 6-3. Automatic DTP/DTF Overlay



## 6-4 Trace Menu, Distance-to-PIM

Key Sequence: **Shift, Trace (5)**

Trace	<b>Copy Active Trace to Overlay:</b> Press this submenu key to create a copy of the current (active) trace. The trace changes color (refer to Select Trace Color submenu key) when it has been stored to memory. If a valid DTP trace is not available, then pressing this submenu key briefly displays a warning message on the screen. Refer to <a href="#">“Valid Trace”</a> .
Copy Active Trace to Overlay	
Trace Overlay	<b>Trace Overlay</b>
Off DTP DTF	<b>Off DTP DTF:</b> Press this submenu key to toggle the trace overlay functions. If a valid DTP or DTF trace is not available, then pressing this submenu key briefly displays a warning message on the screen.
Select Trace Color	<b>Select Trace color:</b> Press this submenu key to select a color from the Select Color choice box. See <a href="#">Figure 6-5</a> . The chosen color is applied to the stored (overlay) trace. When the active trace is copied, it immediately changes to the color that has been set by this submenu key.
Load	<b>Load DTF Trace:</b> Press this submenu key to display the Recall menu and dialog box. Refer to the PIM Master User Guide for more details.
DTF Trace →	
DTF Trace Top 0.0 dB	<b>DTF Trace Top:</b> Press this submenu key to move the upper portion of the DTF trace by expanding or contracting its vertical scale.
DTF Trace Bottom 60.0 dB	<b>DTF Trace Bottom:</b> Press this submenu key to move the lower portion of the DTF trace by expanding or contracting its vertical scale.

**Figure 6-4.** Trace Menu – Distance-to-PIM

Moving the top or bottom of the DTF trace allows you to visually compare the distances between key peaks of DTP versus DTF.

## Select Color Choice Box



Figure 6-5. Overlay Trace Color Selection

## Valid Trace

A valid active trace is required for using the trace overlay function. An active trace is valid after running a DTP measurement (using the Test submenu key). It remains valid until one of the following changes takes place:

- Changing the measurement mode.
- Performing any function that would require a recalibration.
- Turning the PIM Master Off and back On (rebooting).

## 6-5 Trace Menu, Noise Floor - Spectrum View

Key Sequence: **Shift, Trace (5)**

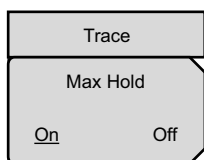

**Max Hold:** Only visible when the Noise Floor - Spectrum View submenu key is selected. When **Off** is underlined, the trace will change during each sweep to show the current signal level for that sweep. When **On** is underlined, the trace level will only be updated if the new signal level is greater than the last signal level for each frequency.

Figure 6-6. Trace Menu – Spectrum View

# Chapter 7 — Swept PIM

The Anritsu PIM Master is capable of producing 80 Watts of RF power in the cellular communications bands. Users must take precautions to minimize exposure to these RF fields:

## **Warning**

Always terminate the PIM output port of the test equipment into a load, a loaded line, or a line that will radiate or absorb the energy before beginning a PIM test.

Confirm that the PIM Master RF power is off after a PIM test.

Always confirm that the PIM RF power is off before disconnecting a coaxial connection, otherwise RF burns may result. Immediate burns to fingers or eyes can result from exposure to live connectors.

Ensure that all antennas under test are placed so that no personnel are exposed to RF levels that exceed the maximum allowable exposure.

## **7-1 Introduction – Swept PIM Analyzer**

PIM measurements are the vector sum of all PIM signals that are generated on a line at the IM frequency being tested. When multiple PIM sources exist, it is possible for the signals to combine out of phase at a particular test frequency to indicate a passing result when the individual PIM levels are actually failures. A Swept PIM test varies the IM frequency over a range of frequencies to provide you with a clearer picture of the true PIM performance of the system.

## 7-2 Swept PIM Setup

**Note**

The default frequency settings for the PIM Master have been chosen to maximize the swept IM product frequency range within the receive range of the instrument. If required, the default sweep frequencies can be changed in the [“Swept PIM Aid Menu”](#) on page 7-8.

1. Turn on power to the PIM Master.
2. Select the PIM Analyzer mode.
3. Select the Swept PIM measurement from the Measurements menu (refer to [“Measurements Menu”](#) on page 2-18).
4. Connect the test cable between the test port connector of the PIM Master to the device under test (DUT).

**Warning**

Confirm that connections are secure. High power RF signals are emitted from the PIM test port and can cause bodily injury. Anritsu recommends using a torque wrench for this connection.

This device (DUT) may be the main feeder cable from the tower or a simple jumper cable. The DUT must be connected to a load device, such as a low PIM load or an Antenna.

**Caution**

Do not use a Site Master precision load as the load device because they are not designed to handle the power of the PIM Master and will become damaged immediately.

## 7-3 Configure the Swept PIM Test

To configure the PIM test:

### 1. Frequency Step Size Setup

- a. Press the **Freq** main menu key to display the frequency menu. Set the **Step Size** and the desired **Intermod Order**.
- b. Press the **Swept PIM Aid** submenu key.

### 2. Swept PIM Parameters Dialog Box

- a. Use the **Arrow** keys or the touch screen to select a **Start** or **Stop** frequency box, then use the number keypad to enter a frequency.
- b. Press **Continue** on the touch screen or press the **Back** submenu key to return to the frequency menu.

### 3. Amplitude Setup

- a. Press the **Amplitude** main menu key to display the Amplitude menu.
- b. Press the **Reference Level** submenu key. The numeric value and units turn red indicating that the settings are ready for editing. Enter the desired reference level using the keypad or the **Arrow** keys. Press **Enter**.
- c. Press the **Scale** submenu key to change the divisions of the grid to a setting other than the default value of 8 dB.
- d. Press the **Units** submenu key to choose dBm or dBc.

### 4. Power and Display Setup

- a. Press the **Setup** main menu key to display the Setup menu.
- b. Press the **High Output Power** or the **Low Output Power** submenu key to enter the power level of the RF test signal.
- c. Press the **Test Duration** submenu key. Enter the desired test time (time that the RF signal from the PIM Master is On) by using the keypad or the **Arrow** keys. Then press **Enter**. The maximum time is 1200 seconds.

### 5. Calibration

If calibration is needed, refer to section [“Calibrating the PIM Analyzer” on page 2-4](#).

## 7-4 Making the Swept PIM Measurement

1. Press the **Measurements** main menu key. The Measurements menu is displayed.

<b>Note</b>	Calibration must be On to make accurate measurements. If the Instrument Settings Summary shows Calibration Off, you must calibrate before measuring.
-------------	--

2. Begin testing by pressing the **Test** submenu key, **Measure** is underlined while the test signal is being transmitted, and the **Test** submenu key is highlighted in Red (see [Figure 2-9 on page 2-19](#)). Two high-power test signals are transmitted from the PIM Master test port to the DUT. PIM generated by the DUT is returned to the PIM Master. The results are displayed. The red RF On light on the PIM Master top panel illuminates during the PIM test, and **RF ON** is displayed in red in the PIM Summary Table on the measurement display screen (see [Figure 3-3 on page 3-6](#) for a sample of the RF ON red indication).

Test duration is specified in the **Setup** main menu. You can terminate the test early by pressing the **Test** submenu key so that **Off** is underlined.

3. Save the current measurement by pressing the **Save Measurement** submenu key. The Save dialog box opens.
4. Type a name for the measurement to be saved and press **Enter**.

## 7-5 Measurement Example

Swept PIM measurements are made by holding one test tone fixed and sweeping the other test tone across a range of transmit frequencies causing the IM frequency to also change. When a system has one dominant PIM source, the magnitude of the PIM tends to be relatively flat versus frequency. When more than one PIM source is present in a system, you may see that the PIM signals add or subtract based on the phase difference between the two signals. This is what is shown in the sample measurement that is shown in [Figure 7-1](#).

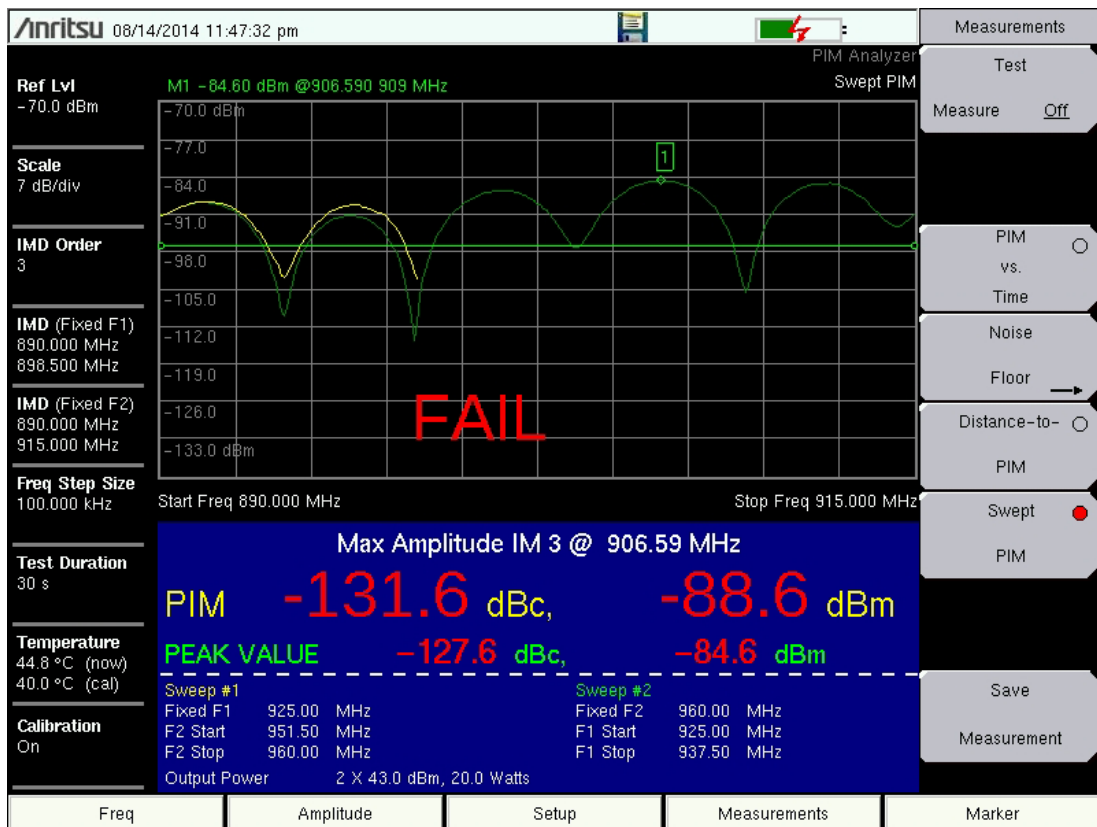

**Figure 7-1.** Swept PIM with More Than One PIM Source

In this measurement, two PIM sources are spaced 5 meters apart. Each source is a loose RF connection, and they create PIM sources of approximately equal magnitude. The limit line is set at  $-97$  dBm ( $-140$  dBc), which is typical for site testing. You can see that at some frequencies, the PIM signals subtract (resulting in a Pass measurement), and at other frequencies, they add together (resulting in a Fail measurement). If this test had used fixed, two-tone testing and happened to select two transmit tones that put the IM signal into one of the nulls, then the trace would have indicated that this site was very good, when it is actually bad. Using Swept PIM is a method to verify this condition.

## 7-6 Menu Map

Figure 7-2 shows the map of the Swept PIM Analyzer menus. Menu maps typically display all possible submenu keys, although some keys are displayed on the instruments only under special circumstances (refer to menu descriptions on the following pages). The following sections describe main menus and associated submenus.

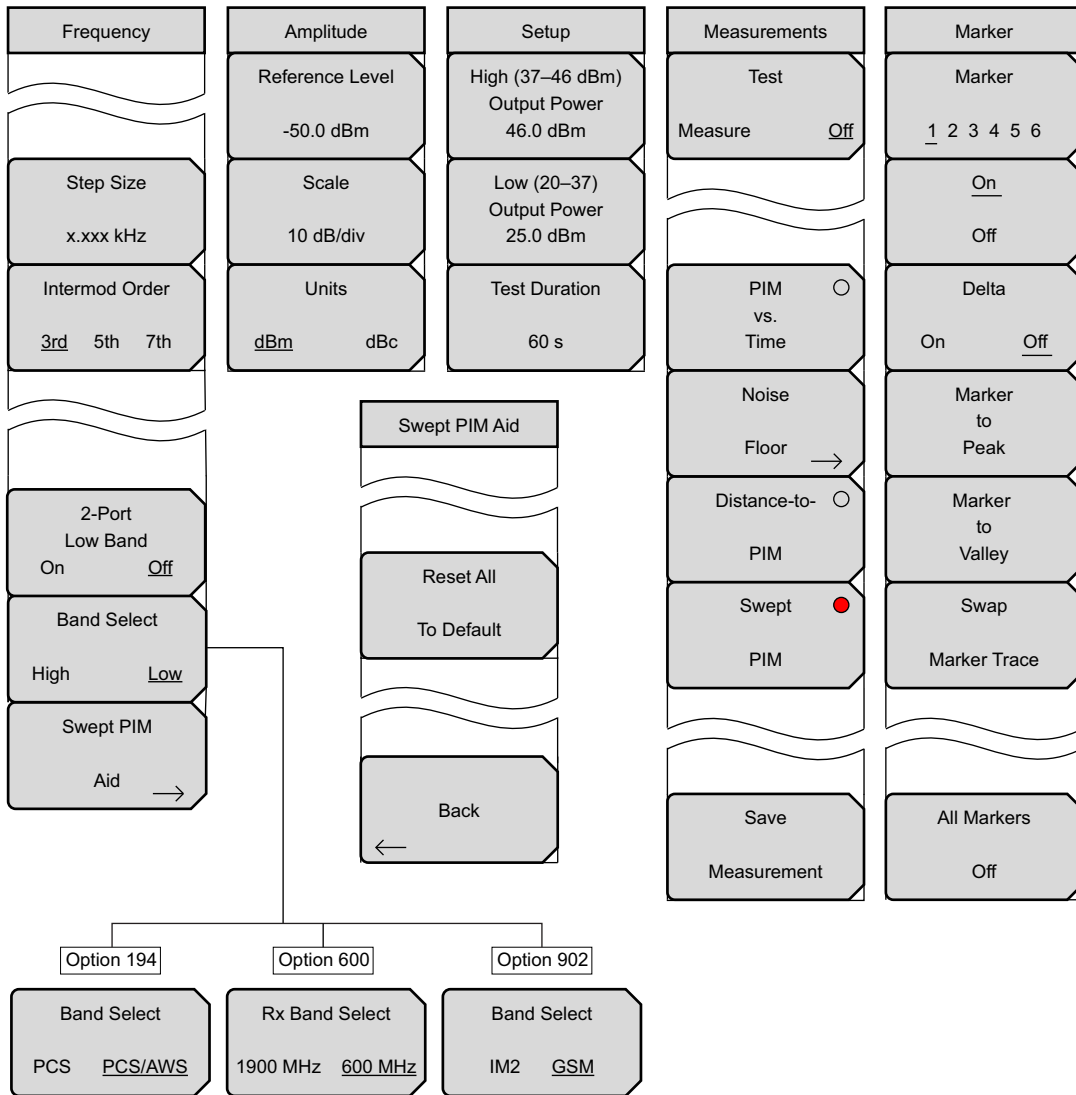
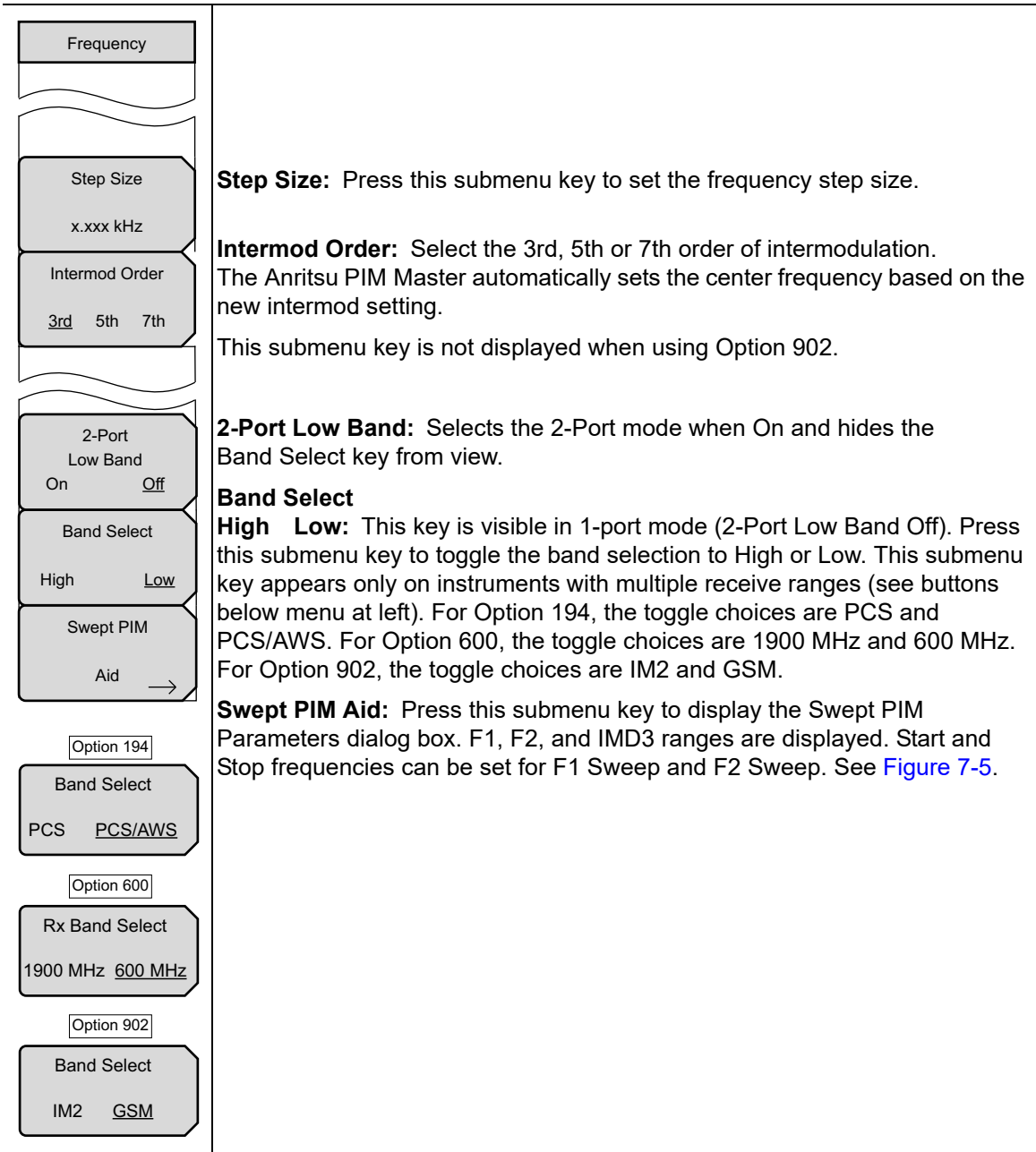

Figure 7-2. Swept PIM Analyzer Menu Map



## 7-7 Frequency (Freq) Menu

Key Sequence: **Freq**

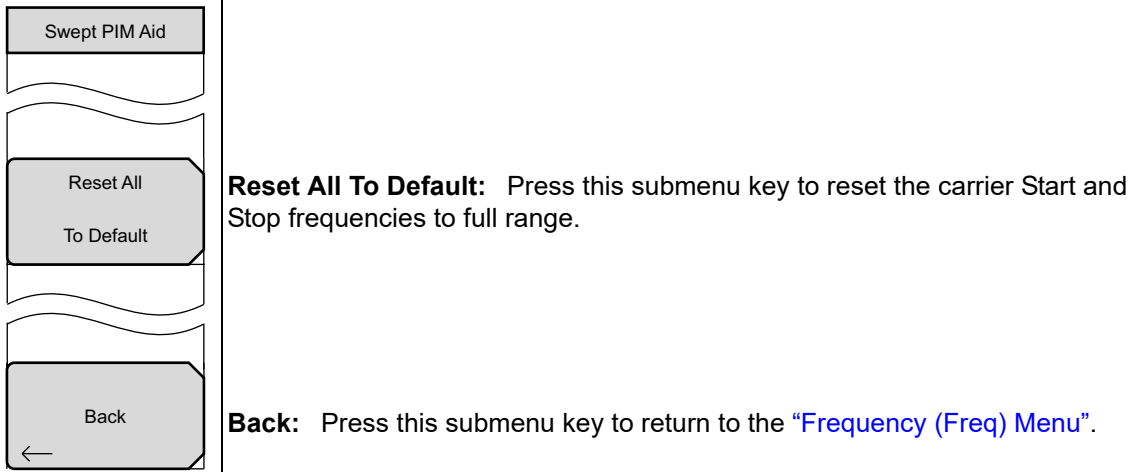

**Figure 7-3.** Frequency Menu

**Note**

The left-most main menu key is labeled **Freq** in the PIM vs. Time and the Swept PIM measurement settings. It is labeled **Distance** in the Distance-to-PIM measurement setting.

## Swept PIM Aid Menu



**Figure 7-4.** Swept PIM Aid Menu

## Swept PIM Parameters Dialog Box

Key Sequence: **Freq** > Swept PIM Aid

Anritsu 08/14/2014 11:46:44 pm Swept PIM Aid

### Swept PIM Parameters

F2 SWEEP		F1 SWEEP	
F2 Start:	951.500	F1 Start:	925.000
F2 Stop:	960.000	F1 Stop:	937.500
IMD 3 Range:	890.00 - 898.50	IMD 3 Range:	890.00 - 915.00

F1 Range: 925.00–937.50 MHz  
F2 Range: 951.50–960.00 MHz  
IMD Range: 880.00–915.00 MHz

Continue

Reset All To Default

Back

Freq Amplitude Setup Measurements Marker

**Figure 7-5.** Swept PIM Parameters Dialog Box

## 7-8 Amplitude Menu

Key Sequence: **Amplitude**

<div style="border: 1px solid black; padding: 2px; margin-bottom: 2px;">Amplitude</div> <div style="border: 1px solid black; padding: 2px; margin-bottom: 2px;">Reference Level -50.0 dBm</div> <div style="border: 1px solid black; padding: 2px; margin-bottom: 2px;">Scale 10 dB/div</div> <div style="border: 1px solid black; padding: 2px;">Units dBm      dBc</div>	<p><b>Reference Level:</b> The reference level is the top graticule line on the display, and can be set from -50 dBm to -140 dBm. A value may be entered from the keypad, use the ± key for a minus sign. After entering the value press the dBm submenu key or the <b>Enter</b> key. The <b>Up/Down</b> arrow keys change the reference level in 10 dB steps, and the <b>Left/Right</b> arrow keys change the value by 1 dB.</p> <p><b>Scale:</b> The scale can be set in 1 dB steps from 1 dB per division to 15 dB per division. The value can be changed using the keypad or the <b>Arrow</b> keys.</p> <p><b>Units</b> <b>dBm   dBc:</b> Toggles the measurement display units between dBm and dBc. The amplitude for upper and lower limits automatically adjusts to the equivalent level for the selected units.</p>
--	---

Figure 7-6. Amplitude Menu

## 7-9 Setup Menu

Key Sequence: **Setup**

<div style="border: 1px solid black; padding: 2px; margin-bottom: 2px;">Setup</div> <div style="border: 1px solid black; padding: 2px; margin-bottom: 2px;">High (37–46 dBm) Output Power 46.0 dBm</div> <div style="border: 1px solid black; padding: 2px; margin-bottom: 2px;">Low (20–37) Output Power 20.0 dBm</div> <div style="border: 1px solid black; padding: 2px; margin-bottom: 2px;">Test Duration 60 s</div> <div style="border: 1px solid black; padding: 2px; margin-bottom: 2px;">High Reflection Bypass On      <u>Off</u></div>	<p><b>High (37–46 dBm) Output Power:</b> Press this submenu key to set the output power level within the higher range for both carrier frequencies, F1 and F2.</p> <p><b>Low (25–37 dBm) Output Power:</b> Press this submenu key to set the output power level within the lower range for both carrier frequencies, F1 and F2.</p> <p><b>Note:</b> Power output value from the test port is twice the set output value. For example, when <b>Setup &gt; Output Power</b> is set to 20 W, total output power is 40 W.</p> $20 \text{ W (F1)} + 20 \text{ W (F2)} = 40 \text{ W}$ <p><b>Test Duration:</b> Press this submenu key to set the length of time that the test port will deliver power after Test is pressed in the <b>Measurements</b> menu. Range for the test is 1 second to 1200 seconds. Use the <b>Arrow</b> keys or the number keypad. If you use the number keypad, then the Units menu of the Test Duration menu is displayed.</p> <p><b>High Reflection Bypass:</b> When on it disables the auto shutoff when a high reflection event occurs.</p>
---	---

Figure 7-7. Setup Menu for Swept PIM

## 7-10 Marker Menu

Marker 1 is always On and always set to the trace peak.

Key Sequence: **Marker**

Marker	
Marker <u>1</u> 2 3 4 5 6	<b>Marker:</b> Press this submenu key to select which marker (1, 2, 3, 4, 5, 6) is active. The underlined marker number is the active marker. See <a href="#">Figure 7-9</a> .
<u>On</u> Off	<b>On/Off:</b> Press this submenu key to turn On or Off the selected (underlined) marker in the <b>Marker</b> submenu key.
Delta On <u>Off</u>	<b>Delta On Off:</b> Press this submenu key to turn on a delta marker and to prompt for a delta offset value, either positive or negative from the value of the currently active marker.
Marker to Peak	<b>Marker to Peak:</b> Press this submenu key to place the currently active marker on the highest signal amplitude that is currently displayed on screen.
Marker to Valley	<b>Marker to Valley:</b> Press this submenu key to place the currently active marker on the lowest signal amplitude that is currently displayed on screen.
Swap Marker Trace	<b>Swap Marker Trace:</b> Press this submenu key to move the active marker from one trace to another (between F1 and F2).
~~~~~	
All Markers Off	<b>All Markers Off:</b> Turns off all displayed markers.

**Figure 7-8.** Setup Menu for Swept PIM

Select Marker		
M1	M2	M3
M4	M5	M6

**Figure 7-9.** Marker Selection Box

### Measurements Menu

Refer to [“Measurements Menu” on page 2-18](#).



# Appendix A — PIM Carrier Bands

## A-1 Introduction

PIM tests are conducted by transmitting two test signals, F1 and F2, into the system under test and then measuring intermodulation products created by those test signals that fall within the receive band of the system. The PIM Master transmit signals are user adjustable within the range shown in [Table A-1](#).

## A-2 PIM Master Carrier Bands

**Table A-1.** PIM Master Carrier Bands and Frequencies

Carrier Band	Frequency Range		Option Number	Rx Frequency Range, MHz
	F1	F2		
LTE 600 MHz	617 MHz to 618 MHz	633 MHz to 652 MHz	MW82119B-0600	663 to 698 1867 to 1888
LTE 700 MHz	731 MHz to 734.5 MHz	746 MHz to 768 MHz	MW82119B-0700	698 to 717 777 to 806
APT 700 MHz	758 MHz to 776 MHz	788 MHz to 803 MHz	MW82119B-0701	710 to 748 825 to 845
APT 700 MHz	768 MHz to 776 MHz	788 MHz to 807 MHz	MW82119B-0702	713 to 738 825 to 845
LTE 700 MHz	731 MHz to 734.5 MHz	746 MHz to 768 MHz	MW82119B-0703	698 to 717 777 to 806
LTE 800 MHz	791 MHz to 795 MHz	811.5 MHz to 821 MHz	MW82119B-0800	832 to 862
Cellular 850 MHz	869 MHz to 871 MHz	881.5 MHz to 894 MHz	MW82119B-0850	824 to 849
E-GSM 900 MHz	925 MHz to 937.5 MHz	951.5 MHz to 960 MHz	MW82119B-0900	880 to 915
E-GSM 900 MHz	925 MHz to 937.5 MHz	951.5 MHz to 960 MHz	MW82119B-0902	885 to 915 1877 to 1920

**Table A-1.** PIM Master Carrier Bands and Frequencies

Carrier Band	Frequency Range		Option Number	Rx Frequency Range, MHz
	F1	F2		
DCS 1800 MHz	1805 MHz to 1837 MHz	1857.5 MHz to 1880 MHz	MW82119B-0180	1710 to 1785
PCS 1900 MHz	1930 MHz to 1945 MHz	1965 MHz to 1995 MHz	MW82119B-0194	1850 to 1910
PCS/AWS 1900/2100 MHz	1930 MHz to 1945 MHz	2110 MHz to 2155 MHz	MW82119B-0194	1710 to 1755
UMTS 2100 MHz	2110 MHz to 2112.5 MHz	2130 MHz to 2170 MHz	MW82119B-0210	1920 to 1980 (IM7) 2050 to 2090 (IM3)
LTE 2600 MHz	2620 MHz to 2630 MHz	2650 MHz to 2690 MHz	MW82119B-0260	2500 to 2570



# Appendix B — Windowing

## B-1 Introduction

The theoretical requirement for inverse FFT is for the data to extend from zero frequency to infinity. Side lobes appear around a discontinuity because the spectrum is cut off at a finite frequency. Windowing reduces the side lobes by smoothing out the sharp transitions at the beginning and at the end of the frequency sweep. As the side lobes are reduced, the main lobe widens, thereby reducing the resolution.

## B-2 Distance-to-PIM (DTP) Windowing Examples

In situations where a small discontinuity may be close to a large one, side lobe reduction windowing should be used. When distance resolution is critical, Rectangular windowing should be used.

The types of windowing in order of increasing side lobe reduction are: **rectangular**, **nominal side lobe**, **low side lobe**, and **minimum side lobe**. [Figure B-1](#) through [Figure B-4](#) show examples of these types of windowing.

These four measurements were taken on a line with two PIM sources that were spaced 100 feet apart. Rectangular windowing provides the highest resolution, or ability to distinguish closely spaced PIM sources.

## DTP Rectangular Windowing

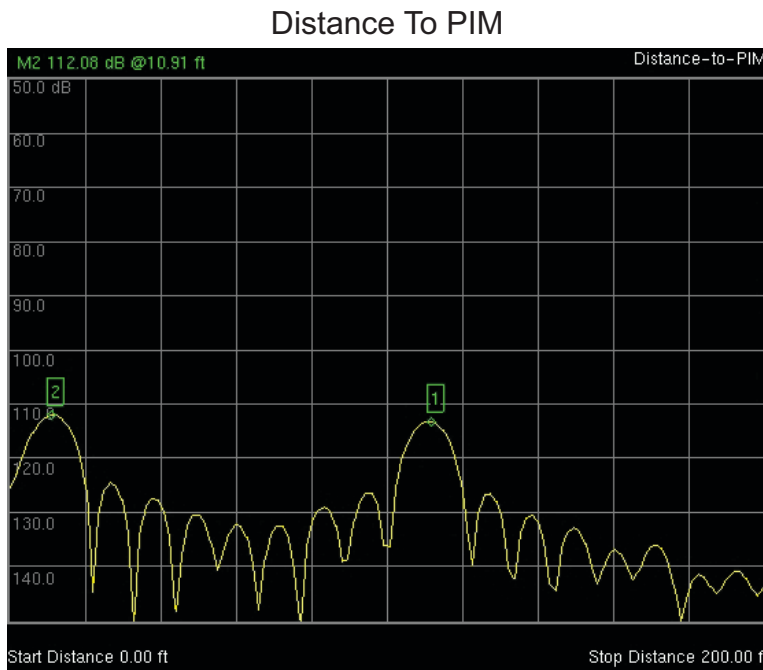
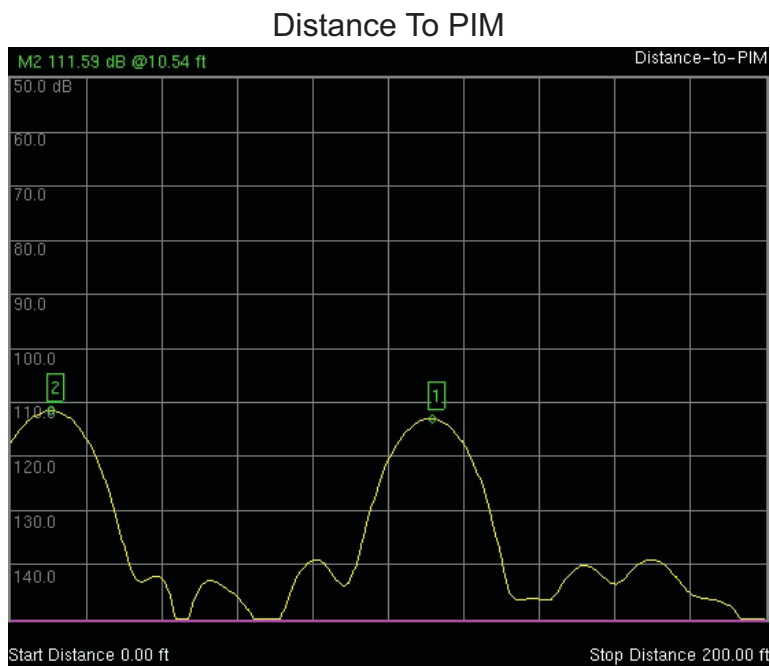

**Figure B-1.** Rectangular Windowing

Total distance is 200 feet. The PIM sources are separated by 100 feet.

This view of Rectangular Windowing shows the maximum side lobe display and the greatest waveform resolution.

### DTP Nominal Side Lobe Windowing

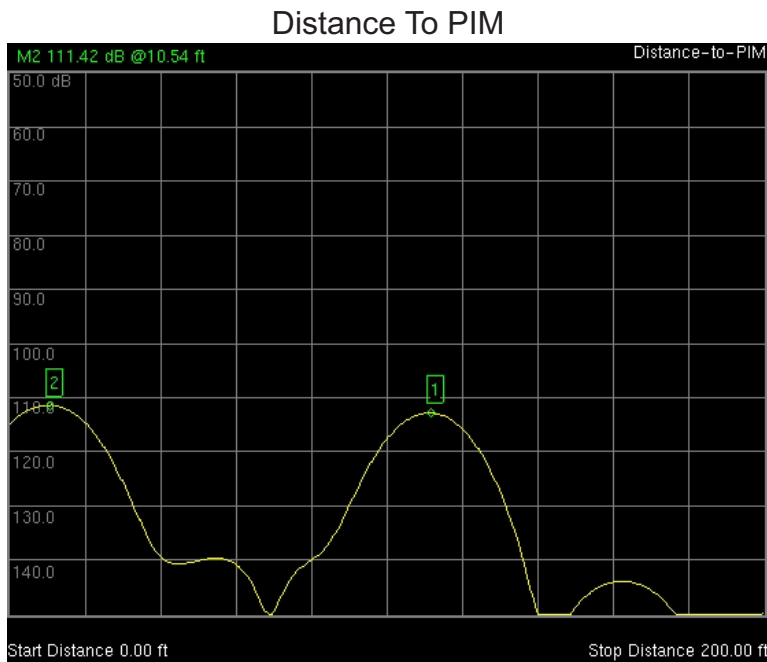

**Figure B-2.** Nominal Side Lobe Windowing

Total distance is 200 feet. The PIM sources are separated by 100 feet.

This view of Nominal Side Lobe Windowing shows less side lobe resolution than Rectangular Windowing and more side lobe resolution than Low Side Lobe Windowing. This level of windowing displays intermediate resolution.

## DTP Low Side Lobe Windowing

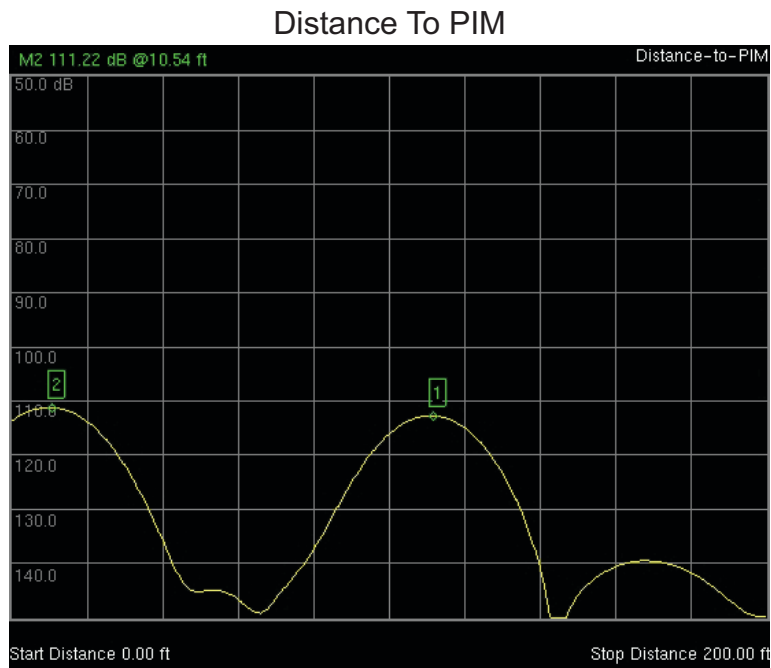

**Figure B-3.** Low Side Lobe Windowing

Total distance is 200 feet. The PIM sources are separated by 100 feet.

This view of Low Side Lobe Windowing shows less side lobe resolution than Nominal Side Lobe Windowing and more side lobe resolution than Minimum Side Lobe Windowing. This level of windowing displays intermediate resolution.

### DTP Minimum Side Lobe Windowing



**Figure B-4.** Minimum Side Lobe Windowing

Total distance is 200 feet. The PIM sources are separated by 100 feet.

This view of Minimum Side Lobe Windowing shows less side lobe resolution than Low Side Lobe Windowing and displays the lowest side lobe and waveform resolution.



# Index

- A**
- active trace ..... 6-6
  - adapter, AC ..... 2-1
  - Amplitude menu
    - DTP ..... 5-24
    - PIM vs. Time ..... 3-14
    - Swept PIM ..... 7-10
  - amplitude setup ..... 3-4, 7-3
  - Anritsu contact ..... 1-1
  - Anritsu, contact ..... 1-1
- B**
- bad load detect, cal ..... 2-6
  - band, carrier bands ..... A-1
  - bars, impulse, enhanced resolution .. 5-12
- C**
- cable
    - cable list dialog box ..... 5-20
    - cable list example ..... 5-21
    - cable list, favorites, example .... 5-22
    - change list with LST ..... 5-20
    - menu, DTP ..... 5-28
  - Cable List menu, DTP ..... 5-20
  - calibrate
    - bad load detect ..... 2-6
    - caution, RF On during calibration 2-4
    - menu ..... 2-21
    - PIM analyzer details ..... 2-4
    - PIM standard, selection ..... 2-5
    - post cal verification ..... 5-3
    - test equipment ..... 2-7
    - verify cal and test cable ..... 2-13
  - carrier bands for PIM ..... A-1
  - causes of PIM ..... 1-3
  - cautions
    - 12VDC adapter ..... 2-1
    - precision load damage ..... 3-3, 7-2
    - RF On during calibration ..... 2-4
  - cell receive band, PIM effects ..... 1-3
  - color selector for overlay trace ..... 6-6
  - compare DTP traces ..... 6-1, 6-3
  - contacting Anritsu ..... 1-1
- D**
- data points described ..... 5-2
  - dBc versus dBm ..... 1-2
  - delta marker
    - DTP Analyzer ..... 5-27
    - PIM vs. Time Analyzer .... 3-16, 7-11
  - description of PIM ..... 1-2
  - dialog box
    - cable list ..... 5-21
    - DTP Parameters ..... 5-4
    - PIM Parameters, PIM vs. Time .. 3-8
    - Swept PIM parameters ..... 7-9
  - display
    - bar graph view ..... 3-7
    - DTP measurement ..... 5-7
    - DTP Parameter window ..... 5-4
    - parameter setup ..... 3-8
    - spectral trace view ..... 3-5
  - distance
    - menu, DTP ..... 5-16
    - windowing resolution ..... B-1
  - Dmax
    - defined ..... 5-2
    - displayed in DTP Parameters .... 5-4
  - DTP
    - analysis chapter ..... 5-1
    - analyzer menu map 1 ..... 5-14
    - analyzer menu map 2 ..... 5-15
    - data points described ..... 5-2
    - distance menu ..... 5-16
    - DTP Aid menu ..... 5-18
    - DTP Parameters dialog box ..... 5-4
    - DTP/DTF trace overlay example .. 6-3
    - DTP/DTP trace overlay example .. 6-1
    - DTP/DTF overlay ..... 5-8
    - limit line, visual reference ..... 5-30
    - marker menu ..... 5-27
    - measurement setup ..... 5-4
    - parameter settings ..... 5-2
    - Parameter Window ..... 5-4
    - post cal verification ..... 5-3
    - setup menu, distance ..... 5-19
    - setup menu, measurement ..... 5-25
    - stationary carrier F1 ..... 5-2
    - swept carrier F2 ..... 5-2
    - trace menu ..... 6-5
    - trace overlay submenu key ..... 5-29
  - dual traces ..... 5-8

**E**

enhanced resolution  
 impulse bars, DTP ..... 5-12  
 main topic ..... 5-12  
 screen image with impulse bars . 5-13  
 submenu key ..... 5-25

error messages  
 IMx Frequency Range ..... 3-4

example  
 amplitude setup .....3-4, 7-3  
 configuring PIM test .....3-3, 7-3  
 DTP meas of PIM Standard ..... 5-3  
 DTP meas overlay ..... 5-11  
 DTP meas setup ..... 5-4  
 DTP meas, antenna & feed line ... 5-7  
 DTP/DTF trace overlay ..... 6-3  
 DTP/DTP trace overlay ..... 6-1  
 DTP/DTF overlay ..... 5-8  
 frequency setup ..... 7-3  
 IM2 and IM3 calculations ..... 1-5  
 IM2 measurements ..... 1-8  
 LST overlay of measurements ... 5-11  
 making DTP measurement ..... 5-7  
 making PIM vs Time measurement 3-9  
 making Swept PIM measurement . 7-4  
 power and display setup .....3-4, 7-3

external interference ..... 2-13

**F**

F1 and F2 ranges ..... A-1

fail indication, PvT ..... 3-11

fast mode  
 PIM vs. Time ..... 3-2

favorites, cable list ..... 5-22

file  
 cable list example ..... 5-21  
 cable list favorites example ..... 5-22

flatten noise floor, PvT ..... 3-2

formula for intermodulation distortion 1-5

frequency  
 menu, PIM vs. Time ..... 3-13  
 menu, Swept PIM ..... 7-7  
 PIM Standards ..... 2-12  
 ranges for F1, F2, and IM ..... A-1  
 setup, Swept PIM ..... 7-3

**H**

http, contacting Anritsu ..... 1-1

**I**

IM frequency ranges ..... A-1

IM2 measurements example ..... 1-8

IM2, IM3 example calculations ..... 1-5

improving range, PvT ..... 3-2

impulse bars  
 enhanced resolution button ..... 5-25  
 enhanced resolution, DTP ..... 5-12  
 screen image ..... 5-13

insertion loss attenuates PIM ..... 1-3

instantaneous measurement values  
 sample PvT measurement ..... 3-5

instrument settings summary ..... 3-2

interference, external ..... 2-13

intermodulation distortion (IMx)  
 formula ..... 1-5

**L**

limit  
 limit line settings ..... 2-15  
 menu ..... 2-20  
 visual reference limit line, DTP . 5-30

line  
 reference limit ..... 5-30

Line Sweep Tools (LST)  
 cable list ..... 5-20  
 overlay measurements example . 5-11  
 test reports ..... 1-11

line sweeping  
 testing work flow ..... 1-7

line sweeping versus PIM testing .... 1-3

links  
 contacting Anritsu ..... 1-1

links, contact ..... 1-1

load detect, cal bad ..... 2-6

low noise mode  
 PIM vs. Time ..... 3-2

**M**

marker  
 menu, DTP ..... 5-27  
 menu, PvT ..... 3-16  
 setup ..... 2-16

Marker menu  
 Swept PIM ..... 7-11



measurements			
basic procedure	2-14		
IM2 example	1-8		
menu, DTP	2-18		
saving			
location	2-16		
submenu	2-16		
type	2-16		
setup, DTP	5-4		
setup, Noise Floor	4-2		
setup, PIM vs Time	3-3		
setup, Swept PIM	7-2		
menu			
calibrate	2-21		
other calibrations	2-22		
trace, DTP	6-5		
menu map			
DTP analyzer, 1	5-14		
DTP analyzer, 2	5-15		
PIM analyzer	2-17		
PIM vs Time	3-12		
Swept PIM	7-6		
menu, DTP			
Amplitude	5-24		
Cable	5-28		
Cable List	5-20		
Distance	5-16		
DTP Aid	5-18		
DTP Setup	5-19		
Marker	5-27		
Measurements	2-18		
Resolution	5-28		
Setup, distance	5-19		
Setup, measurement	5-25		
Test Duration	5-26		
Trace	6-5		
Windowing	5-23		
menu, Noise Floor	4-6		
menu, PIM vs. Time			
Amplitude	3-14		
Frequency	3-13		
Marker	3-16		
Setup	3-15		
menu, Swept PIM			
Aid	7-8		
Amplitude	7-10		
Frequency	7-7		
Limit	2-20		
Marker	7-11		
Reference Limit	5-30		
Setup	7-10		
<b>N</b>			
noise floor			
flattening, PvT	3-2		
measurement setup	4-2		
measurement type	2-14, 4-1		
menu, PIM vs. Time analysis	4-6		
sample spectrum view meas	4-5		
sample time view meas	4-3		
saving measurements	4-5		
views, time versus spectrum	4-1		
<b>O</b>			
o-ring			
save wear	2-13		
other calibrations			
menu	2-22		
overlay trace			
color selector	6-6		
overlay trace uses	6-1		
overlay traces	5-8		
<b>P</b>			
parameter setup dialog box			
DTP	5-4		
PIM vs Time	3-8		
Swept PIM	7-9		
peak PIM values			
sample PvT measurement	3-5		

**PIM**

- analyzer menu map .....2-17, 3-12
- carrier bands .....A-1
- causes of false pass ..... 1-3
- causes of PIM ..... 1-3
- description ..... 1-2
- DTP Parameter window ..... 5-4
- high return loss masks PIM ..... 1-3
- insertion loss attenuation ..... 1-3
- line sweeping and PIM testing ... 1-3
- measurements ..... 7-4
- reasons for testing ..... 1-3
- resolving sources ..... 5-12
- standards, frequencies ..... 2-12
- standards, in calibration ..... 2-5
- standards, power in dBm dBc ... 2-12
- testing procedure, general ..... 1-6
- verifying PIM Standard ..... 2-7
- verifying residual PIM ..... 2-7, 2-11

**PIM summary table** ..... 3-6

**PIM vs Time**

- amplitude menu ..... 3-14
- amplitude setup ..... 3-4
- analysis chapter ..... 3-1
- example intermod calculation .... 3-3
- fast mode ..... 3-2
- frequency menu ..... 3-13
- marker menu ..... 3-16
- measurement setup ..... 3-3
- measurements ..... 3-9
- menu map ..... 3-12
- PIM Parameters dialog box ..... 3-8
- PIM Summary table ..... 3-6
- power and distance setup ..... 3-4
- sample measurement ..... 3-10
- setup menu ..... 3-15
- spikes of short duration ..... 3-2
- trace mode ..... 3-2

**power**

- PIM Standards ..... 2-12
- setup .....3-4, 7-3
- true vs relative ..... 1-2

**precision load caution** .....3-3, 7-2

**Q**

- quick name matrix ..... 2-16

**R**

- range improvement, PvT ..... 3-2
- reasons for PIM testing ..... 1-3
- red numerals
  - limit exceeded, sample ..... 3-5
- reference limit
  - menu ..... 5-30
- relative power ..... 1-2
- reports, LST ..... 1-11
- residual PIM verification ..... 2-7, 2-11
- resolution
  - enhancement, DTP ..... 5-12
  - impulse bars, image ..... 5-13
  - menu, DTP ..... 5-28
  - windowing ..... B-1
- resolving PIM sources ..... 5-12
- return loss can mask PIM ..... 1-3

**S**

**save**

- noise floor measurements ..... 4-5

**setting limit line values** ..... 2-15

**setting summary** ..... 3-2

**setup for measurement**

- DTP ..... 5-4
- Noise Floor ..... 4-2
- PIM vs Time ..... 3-3
- Swept PIM ..... 7-2

**Setup menu**

- DTP, distance ..... 5-19
- DTP, measurement ..... 5-25
- PIM vs. Time ..... 3-15
- Swept PIM ..... 7-10

**sources of PIM** .....1-2, 1-3

**spectrum view, noise floor** ..... 4-5

**spikes of short duration, PvT** ..... 3-2

**standards**

- PIM, calibration, choosing ..... 2-5
- PIM, frequencies ..... 2-12
- PIM, verifying ..... 2-7

**summary table, PIM** ..... 3-6

Swept PIM			
aid menu	7-8		
amplitude menu	7-10		
amplitude setup	7-3		
analysis chapter	7-1		
frequency menu	7-7		
frequency step size setup	7-3		
making a measurement	7-4		
marker menu	7-11		
measurement examples	7-5		
measurement setup	7-2		
menu map	7-6		
parameters dialog box	7-9		
power and display setup	7-3		
setup menu	7-10		
test configuration	7-3		
<b>T</b>			
Test Duration menu, DTP	5-26		
test port			
save wear	2-13		
test reports, LST	1-11		
testing			
for external interference	2-13		
testing setup			
DTP	5-4		
Noise Floor	4-2		
PIM vs Time	3-3		
Swept PIM	7-2		
time view, noise floor	4-3		
torque wrench recommended for safety	7-2		
trace			
color selector	6-6		
function description	6-1		
menu, DTP	6-5		
overlay			
features	6-1		
overlay DTP/DTF example	6-3		
overlay DTP/DTP example	6-1		
valid	6-6		
trace mode			
fast	3-2		
low noise	3-2		
PIM vs. Time	3-2		
submenu key	3-15		
trace overlay	5-8		
example display	6-2		
submenu key	2-18, 5-29, 6-5		
true power	1-2		
two-port			
calibration	2-8		
mode	2-8		
option 703	2-12		
<b>U</b>			
URL contacting Anritsu	1-1		
<b>V</b>			
valid trace	6-6		
verifying			
calibration and test cable	2-13		
calibration and test equipment	2-7		
instrument setup	2-7, 2-13		
PIM Standard	2-7		
post cal, DTP	5-3		
residual PIM	2-7, 2-11		
<b>W</b>			
warnings			
high reflection, measurement path	2-14		
injury from			
RF power	2-1, 3-1, 3-3, 5-1, 7-1, 7-2		
web links, contact	1-1		
Web site, contacting Anritsu	1-1		
windowing			
description and examples	B-1		
menu, DTP	5-23		





# Anritsu



Anritsu utilizes recycled paper and environmentally conscious inks and toner.

Anritsu Company  
490 Jarvis Drive  
Morgan Hill, CA 95037-2809  
USA  
<http://www.anritsu.com>