

Operation Manual

# VectorStar™ MS464xB Series Microwave Vector Network Analyzer

MS4642B VNA, 10 MHz to 20 GHz, K Connectors

MS4644B VNA, 10 MHz to 40 GHz, K Connectors

MS4645B VNA, 10 MHz to 50 GHz, V Connectors (No longer available)

MS4647B VNA, 10 MHz to 70 GHz, V Connectors



**Anritsu**

## **NOTICE**

Anritsu Company has prepared this manual for use by Anritsu Company personnel and customers as a guide for the proper installation, operation and maintenance of Anritsu Company equipment and computer programs. The drawings, specifications, and information contained herein are the property of Anritsu Company, and any unauthorized use or disclosure of these drawings, specifications, and information is prohibited; they shall not be reproduced, copied, or used in whole or in part as the basis for manufacture or sale of the equipment or software programs without the prior written consent of Anritsu Company.

## **UPDATES**

The latest service and sales contact information, and updated documents can be downloaded from the Anritsu Website at: <http://www.anritsu.com>

# Table of Contents

---

## Chapter 1 — Overview

1-1	Introduction . . . . .	1-1
1-2	Contacting Anritsu for Sales and Service . . . . .	1-1
1-3	VectorStar MS464xB Series VNA Description . . . . .	1-2
1-4	VectorStar MS464xB Series VNA Models . . . . .	1-3
1-5	VNA Instrument Control . . . . .	1-3
	Graphical User Interface . . . . .	1-4
	Front Panel Hard Keys . . . . .	1-4
	System Identification and Computer Name . . . . .	1-4
	Precision Component and Calibration Kits . . . . .	1-4
	Automatic Calibrators . . . . .	1-4
1-6	Related Documentation . . . . .	1-5
	Product Information, Compliance, and Safety . . . . .	1-5
	VectorStar MS464xB Series Vector Network Analyzers . . . . .	1-5
	VectorStar ME7838 Series 2-Port BB/mmWave VNA Measurement System . . . . .	1-5
	VectorStar ME7838 Series 2-Port BB/mmWave VNA Measurement System (cont.) . . . . .	1-6
	VectorStar ME7838 Series Multiport BB/mmWave VNA Measurement System . . . . .	1-6
	VectorStar MN469xC Series Multiport VNA Measurement System . . . . .	1-6
	Optoelectronic Network Analyzer Systems and Components . . . . .	1-6
	Calibration, Verification, and System Performance Verification . . . . .	1-7
1-7	Documentation Conventions . . . . .	1-8
1-8	Operating System . . . . .	1-9
	Maintaining Operating System Integrity . . . . .	1-9
	Antivirus Protection . . . . .	1-9
	Windows Updates . . . . .	1-9

## Chapter 2 — Installation

2-1	Introduction . . . . .	2-1
2-2	Unpacking the Product . . . . .	2-1
	Initial Inspection . . . . .	2-1
	Preparation for Use . . . . .	2-1
2-3	Operating Environment and Power Requirements . . . . .	2-2
2-4	Power-On/Power-Off Procedures . . . . .	2-3
	Procedure – Power-On to Standby Mode . . . . .	2-4
	Procedure – Standby Mode to Operate Mode . . . . .	2-4
	Procedure – Operate Mode to Standby Mode . . . . .	2-5
	Procedure – Standby Mode to Power-Off . . . . .	2-6
2-5	Connecting External Devices . . . . .	2-6
	Connecting an External Mouse or Keyboard . . . . .	2-6
	Connecting an External XGA/VGA Monitor . . . . .	2-7
	Connecting an External Printer . . . . .	2-8
	Connecting Other USB Peripherals . . . . .	2-8

## Table of Contents (Continued)

---

2-6	GPIB Setup . . . . .	2-9
	Configuring the Dedicated GPIB Port . . . . .	2-9
	Configuring the IEEE 488.2 GPIB Port . . . . .	2-14
	Configuring the VectorStar VNA GPIB Address . . . . .	2-15
2-7	Ethernet LAN TCP/IP and USB Setup . . . . .	2-16
	Default Plug-and-Play Configuration . . . . .	2-16
	Manually Configuring TCP/IP Ethernet LAN Settings . . . . .	2-18
2-8	Configuring the Remote Language . . . . .	2-19
2-9	Calibration/Verification Interval . . . . .	2-19

### Chapter 3 — Front and Rear Panels

3-1	Chapter Overview . . . . .	3-1
3-2	Front Panel Touch Screen . . . . .	3-1
3-3	Front Panel Hard Keys and Connectors . . . . .	3-2
	Front Panel Hard Key and Connector Description . . . . .	3-4
3-4	Rear Panel Ports and Connectors . . . . .	3-12
	Rear Panel Port and Connector Descriptions . . . . .	3-14

### Chapter 4 — User Interface Display

4-1	Chapter Overview . . . . .	4-1
4-2	User Interface Main Screen . . . . .	4-1
	User Interface Control and Display Areas . . . . .	4-2
	Function Access . . . . .	4-5
4-3	Using the Front Panel Keys . . . . .	4-7
4-4	Using the Menu Bar Interface . . . . .	4-8
	Menu Bar Overview . . . . .	4-8
	Menu Bar General Operation . . . . .	4-9
	Menu Bar Drop-Down Menus and Commands . . . . .	4-9
4-5	Icon Toolbar . . . . .	4-21
	Overview . . . . .	4-21
	Using the Icon Toolbar Interface . . . . .	4-21
	Available Icon Functions . . . . .	4-21
	CUSTOMIZE (ICON) TOOLBAR Dialog Box . . . . .	4-28
4-6	MAIN Menu and Application Menus . . . . .	4-29
	MAIN Menu . . . . .	4-29



## Table of Contents (Continued)

---

4-7	Using the Main Menu Interface . . . . .	4-31
	Types of Menus, Menu Buttons, and Menu Toolbars . . . . .	4-31
	Menu Title . . . . .	4-32
	Menu Buttons . . . . .	4-32
	Menu Navigation Buttons . . . . .	4-32
	Back Button . . . . .	4-32
	Next Button . . . . .	4-32
	Home Button . . . . .	4-32
	Menu Buttons . . . . .	4-32
	Display Button . . . . .	4-32
	Plain Buttons . . . . .	4-33
	Toggle Buttons . . . . .	4-33
	Field Selection Buttons . . . . .	4-33
	Field Toolbars . . . . .	4-34
	Button Selection Icon. . . . .	4-34
	Button Selection Groups . . . . .	4-35
	Auto-Return Button Groups. . . . .	4-36
	Completion Checkmark Button . . . . .	4-37
4-8	Using Dialog Boxes . . . . .	4-37
	Standard Dialog Box Buttons . . . . .	4-37
4-9	Setting the Main Display as Resizable, and/or Task Bar . . . . .	4-38
	Procedure . . . . .	4-39
4-10	Instrument Status Display Area . . . . .	4-40
	Instrument Status Messages . . . . .	4-41
4-11	Channel Status Display Area . . . . .	4-42
4-12	Working with the Number of Points . . . . .	4-43
	Maximum Points Set to 25,000 . . . . .	4-43
	Maximum Points Set to 100,000 . . . . .	4-43
	To Change the Number of Points . . . . .	4-43
4-13	Working with Channels. . . . .	4-44
	25,000 Point Mode . . . . .	4-44
	100,000 Point Mode . . . . .	4-44
	Channel Detach. . . . .	4-45
	Channel Sweep Control. . . . .	4-46

## Table of Contents (Continued)

---

4-14	Working with Traces	4-47
	Types of Trace Displays	4-47
	Trace Data Types	4-47
	Trace Display Graphs	4-47
	Trace Labels	4-51
	Trace Label Abbreviations	4-52
	Rectilinear Single Graph	4-54
	Rectilinear Paired Graphs	4-57
	Smith Charts	4-58
	Smith Chart with Impedance (Circuit Resistance and Reactance)	4-58
	Smith Chart with Admittance (Conductance and Susceptance)	4-59
	Polar Graphs	4-60
	Group Delay Graphs	4-60
	Power Graphs	4-62
	Trace Management	4-62
4-15	Working with Reference Lines and Reference Position	4-64
4-16	Working with Limit Lines	4-65
4-17	Working with Frequency Blanking	4-66

### Appendix A — Vector Network Analyzer Primer

A-1	Appendix Overview	A-1
A-2	General Description	A-2
A-3	Instrument Description	A-3
	Source Module	A-3
	Test Set Module	A-3
	Analyzer Module	A-3
A-4	Network Analyzers	A-4
	Scalar Analyzer Comparison	A-4
	Vector Network Analyzer Basics	A-5
A-5	Polar Display	A-13
	Resistive and Reactive Terms	A-13
A-6	Smith Chart	A-14
	Measurement Error Correction	A-14

### Appendix B — Initial Checkout Procedures

B-1	Introduction	B-1
B-2	Checkout Introduction	B-1
B-3	Required Equipment	B-1
B-4	Self Test Procedure	B-1
	Overview	B-1
	Procedure	B-2
B-5	Non-Ratio Power Procedure	B-4
	Overview	B-4
	Procedure	B-4

## Table of Contents (Continued)

---

B-6	High Level Noise Test . . . . .	B-9
	Overview . . . . .	B-9
	Procedure . . . . .	B-9
B-7	System Noise Floor Test . . . . .	B-13
	Overview . . . . .	B-13
	Procedure . . . . .	B-13

### Appendix C — Security and Maintenance

C-1	Information Security . . . . .	C-1
	Storage and Memory Overview . . . . .	C-1
C-2	Operating System Restore . . . . .	C-2
	Procedure . . . . .	C-2
C-3	Installing and Configuring an Additional Solid State Drive . . . . .	C-3
	Procedure . . . . .	C-3
C-4	Optional Rack Mount Installation . . . . .	C-4
C-5	Fuse Maintenance . . . . .	C-7
	Fuse Summary . . . . .	C-7
	External Rear Panel AC Input Fuses . . . . .	C-7
	Bias Fuse Replacement . . . . .	C-8
C-6	Preparation for Storage or Shipment . . . . .	C-9
	Preparation for Storage . . . . .	C-9
	Preparation for Shipment . . . . .	C-9

### Appendix D — Terms and Abbreviations Glossary

D-1	Appendix Overview . . . . .	D-1
D-2	Glossary . . . . .	D-1

### Index



# Chapter 1 — Overview

## 1-1 Introduction

The *VectorStar Operation Manual* is part of a set of manuals that cover all of the instrument functions and their use. This manual covers the instrument overview, system functions, and other common features, along with a brief guide to basic measurement concepts and setups.

Read the *VectorStar Product Information, Compliance, and Safety Guide (PN: 10100-00063)* for important safety, legal, and regulatory notices *before* operating the equipment. For additional information and literature covering your product, visit the product page of your instrument and select the Library tab.

This chapter provides an overview of the VectorStar™ MS464xB Series Vector Network Analyzer (VNA) and a description of its major functions and available documentation. A summary of available precision component kits including AutoCal™ calibration kits, mechanical calibration kits, and verification kits is included.

## 1-2 Contacting Anritsu for Sales and Service

To contact Anritsu, please visit:

<https://www.anritsu.com/contact-us>

From here, you can select the latest sales, service, and support contact information in your country or region, provide online feedback, complete a *Talk to Anritsu* form to get your questions answered, or obtain other services offered by Anritsu.

Updated product information can be found in the Library tab on your product page:

<https://www.anritsu.com/test-measurement/products/ms4640b-series>

On this web page, you can select various tabs for more information about your instrument. Included is a Library tab which contains links to all the latest technical documentation related to this instrument.

## 1-3 VectorStar MS464xB Series VNA Description

The VectorStar MS464xB Series VNA is an instrument system that contains a built-in source, test set, and analyzer. Test results are displayed real time on a front panel touch screen or also to a separate video monitor. Screen captures can easily be printed or saved in common graphic file formats.

The VectorStar MS464xB Series VNA provides a maximum frequency range from 70 kHz to 70 GHz, depending on model and options. Through its front panel user interface, the instrument can be quickly configured to provide either:

- **25,000 Points**

The VectorStar MS464xB Series VNA has up to 25,000 total test points available, with up to 16 channels, and each channel with up to 16 trace display graphs where each channel is configured as a virtual separate VNA. Each trace can have up to 12 standard markers and one reference marker.

- **100,000 Points**

The VNA can be configured with up to 100,000 total test points, limited to one channel with up to 16 trace display graphs. Each trace can have up to 12 standard markers and one reference marker.

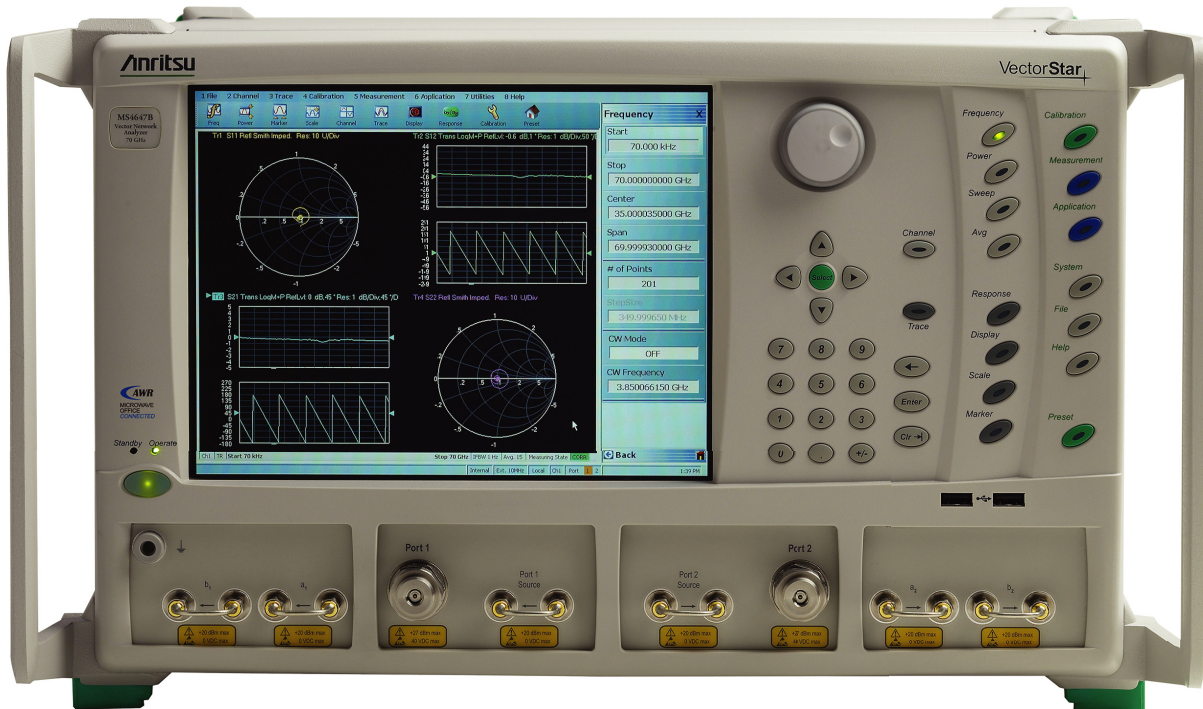


Figure 1-1. VectorStar VNA Front Panel

## 1-4 VectorStar MS464xB Series VNA Models

The VectorStar VNA has four basic models, as shown in [Table 1-1](#).

**Table 1-1.** VectorStar MS464xB Series VNA Models

VNA Model Number	Name	Specifications	Test Port Connectors
MS4642B	Microwave Vector Network Analyzer	10 MHz to 20 GHz	K (m) Connector Test Ports
MS4644B	Microwave Vector Network Analyzer	10 MHz to 40 GHz	K (m) Connector Test Ports
MS4645B	Microwave Vector Network Analyzer (No longer available)	10 MHz to 50 GHz	V (m) Connector Test Ports
MS4647B	Microwave Vector Network Analyzer	10 MHz to 70 GHz	V (m) Connector Test Ports

For additional technical specifications and configuration data, see the following publication:

- VectorStar MS464xB Series VNA Technical Data Sheet and Configuration Guide – 11410-00611

## 1-5 VNA Instrument Control

Most menu functions can be directly accessed by pressing the front panel hard keys. Other than test connectors, I/O connectors, and the main power switch, there are no user controls on the back panel.

The VectorStar MS464xB Series VNA is equipped with an internal drive for storing and recalling front panel and calibration setups, along with measurement information and data. The instrument can be controlled via:

- the front panel buttons and touch screen
- an attached USB keyboard and mouse
- an Ethernet LAN
- a USB LAN
- an IEEE 488.2 General Purpose Interface Bus (GPIB)

**Note**

When operating the VectorStar VNA through remote programming, the front panel user interface and controls are disabled. To return to local front panel control, press the front panel Clear/Tab key [Clr -->], keyboard **Esc** key, or send the `RTL` command. For more information about remote programming, refer to the **VectorStar MS464xB Series VNA Programming Manual**.

The VectorStar MS464xB Series VNA **does not** support Microsoft's Remote Desktop interface.

## Graphical User Interface

The graphical user interface (GUI) provides a combination of a menu command bar, icon task bar, and right-side navigation menu for most system functions. All of the on-screen navigation elements can be accessed by the instrument touch screen or an attached USB mouse and keyboard.

<b>Note</b>	<p>When using the touch screen, a recommended best practice is to use a positive hard press to make sure the required setting is input into the system. A light touch may not change the instrument setting as required.</p> <p>To recalibrate the touch screen, navigate to the CALIBRATE TOUCH SCREEN dialog box located at <b>MAIN   System   SYSTEM   Utility   UTILITY   Calibrate Touch Screen   TOUCH SCREEN CONTROL PANEL dialog box</b>. The procedure is described in the <b>User Interface Reference Manual</b>.</p> <p>A more detailed touch screen calibration and adjustment procedure is described in the <b>VectorStar MS464xB Series VNA Maintenance Manual</b>.</p>
-------------	---

## Front Panel Hard Keys

Most menu functions can be directly accessed by pressing the front panel hard keys. Other than test connectors, I/O connectors, and the main power switch, there are no user controls on the back panel.

## System Identification and Computer Name

All Anritsu instruments are assigned a unique six-digit identification (ID) number such as “080101.” This number is affixed to a decal on the back panel of each unit. Please use this number in any correspondence with Anritsu Customer Service. The computer name is set to SNXXXXXX where XXXXXX is the Anritsu serial number for the instrument.

## Precision Component and Calibration Kits

Two types of precision-component kits are available: calibration and verification. Calibration kits contain components used to identify and separate error sources inherent in microwave test setups. Verification kits consist of components with characteristics traceable to the National Institute of Standards and Technology (NIST) and are used as the most dependable means of checking system accuracy. Each of these kits contains a floppy disk and/or a USB memory device that provides coefficient, characterization, or measurement data for each component. Refer to the relevant data sheet below for detailed specifications on automatic calibrators, mechanical calibration kits, and verification kits:

- **VectorStar MS464xB Series VNA Technical Data Sheet and Configuration Guide**

## Automatic Calibrators

AutoCal modules provide fast and repeatable calibrations with a single connection to the test ports, eliminating susceptibility to user errors and connector wear. The VectorStar MS464xB Series VNA controls the AutoCal module directly for 1- or 2-Port calibrations and Thru Updates. Each AutoCal module is shipped with a characterization file and the necessary serial connection cable.

## Mechanical Calibration Kits

The mechanical calibration kits provide 50 ohm calibrations for SMA, 3.5 mm, K, V, 1 mm, and 0.8 mm devices.



## Verification Kits

Verification kits can be used with the provided software and data to verify the calibration and resulting performance of the VectorStar MS464xB Series VNA. The applicable calibrations are Short-Open-Load-Thru (SOLT) with Sliding Load using the mechanical and AutoCal kits.

<b>Note</b>	Changing the installed location of the front panel Direct Access Loops (13), (15), (16), and (18) (shown in <a href="#">Figure 3-1</a> ) results in changes to the display of the factory RF calibration due to the differing electrical lengths of the loops. Changing locations of these loops have no effect on user RF calibrations.
-------------	--

## 1-6 Related Documentation

All documents listed in this section are available online from the Library tab at:

<https://www.anritsu.com/test-measurement/products/ms4640b-series>, (except for the Calibration, Verification, and System Performance Verification documents, which are included on a USB memory device included in each kit).

On this web page, you can select various tabs for more information about your instrument. Included is a “Library” tab which contains links to all the latest technical documentation related to this instrument.

### Product Information, Compliance, and Safety

- VectorStar Product Information, Compliance, and Safety (PICS) – 10100-00063

### VectorStar MS464xB Series Vector Network Analyzers

- MS464xB Series VNA Technical Data Sheet – 11410-00611
- MS464xB Series VNA Operation Manual – 10410-00317
- MS464xB Series VNA Measurement Guide – 10410-00318
- MS464xB Series VNA User Interface Reference Manual – 10410-00319
- MS464xB Series VNA Maintenance Manual – 10410-00320
- MS464xB Series VNA Programming Manual – 10410-00322
- MS464xB Series VNA Programming Manual Supplement – 10410-00323
- MS464xB Series VNA User Help System – 10450-00040

### VectorStar ME7838 Series 2-Port BB/mmWave VNA Measurement System

- ME7838A Modular BB/mmWave Technical Data Sheet (TDS) – 11410-00593
- ME7838AX/A4X Modular Broadband/mmWave Technical Data Sheet – 11410-02825
- ME7838D Modular BB/mmWave Technical Data Sheet (TDS) – 11410-00778
- ME7838E Modular BB/mmWave Technical Data Sheet (TDS) – 11410-00767
- ME7838EX/E4X Modular Broadband/mmWave Technical Data Sheet – 11410-02827
- ME7838G Modular BB/mmWave Technical Data Sheet (TDS) – 11410-01060
- ME7838A Modular BB/mmWave Quick Start Guide (QSG) – 10410-00292
- ME7838D/G Modular BB/mmWave Quick Start Guide (QSG) – 10410-00732
- ME7838E Modular BB/mmWave Quick Start Guide (QSG) – 10410-00729
- ME7838 Series Modular BB/mmWave Installation Guide (IG) – 10410-00293

## VectorStar ME7838 Series 2-Port BB/mmWave VNA Measurement System (cont.)

- Broadband/Banded mmWave Modules Reference Manual (RM) –10410-00311
- ME7838A-3744 Rx Noise Figure Measurement Guide – 10410-00328
- ME7838 Series Modular BB/mmWave Maintenance Manual (MM) –10410-000306

## VectorStar ME7838 Series Multiport BB/mmWave VNA Measurement System

- ME7838A4 4-Port Broadband VNA Technical Data Sheet (TDS) – 11410-00704
- ME7838AX/A4X Modular Broadband/mmWave Technical Data Sheet – 11410-02825
- ME7838D4 4-Port Broadband VNA Technical Data Sheet (TDS) – 11410-01099
- ME7838E4 4-Port Broadband VNA Technical Data Sheet (TDS) – 11410-01100
- ME7838EX/E4X Modular Broadband/mmWave Technical Data Sheet – 11410-02827
- ME7838G Modular BB/mmWave Technical Data Sheet (TDS) –11410-01060
- ME7838A4 Multiport Broadband/Banded VNA Quick Start Guide (QSG) – 10410-00735
- ME7838D4/G4 Multiport Broadband/Banded VNA Quick Start Guide (QSG) – 10410-00770
- ME7838E4 Multiport Broadband/Banded VNA Quick Start Guide (QSG) – 10410-00771
- ME7838x4 Multiport Broadband/Banded VNA Installation Guide (IG) – 10410-00734
- ME7838A-3744 Rx Noise Figure Measurement Guide – 10410-00328
- ME7838A4 4-Port Broadband VNA Maintenance Manual (MM) – 10410-00736
- Broadband/Banded mmWave Module Reference Manual (RM) – 10410-00311

## VectorStar MN469xC Series Multiport VNA Measurement System

- MN469xC Series Multiport VNA Measurement System Technical Data Sheet – 11410-00777
- MN469xC Series Multiport Test Set Installation Guide – 10410-00737
- MN469xC Series Multiport Test Set Quick Start Guide – 10410-00738
- MN469xC Series Multiport Test Set Maintenance Manual – 10410-00730

## Optoelectronic Network Analyzer Systems and Components

- MN4765B O/E Calibration Module Technical Data Sheet (TDS) – 11410-00843
- MN4765B O/E Calibration Module Operation Manual (OM) – 10410-00742
- MN4775A E/O Converter Operation Manual – 10410-00774
- MN4775A E/O Converter Technical Data Sheet – 11410-01144
- ME7848A Opto-electronic Network Analyzer Quick Start Guide – 10410-00777
- ME7848A Opto-electronic Network Analyzer Maintenance Manual – 10410-00778
- ME7848A Opto-electronic Network Analyzer Technical Data Sheet – 11410-01145

**Calibration, Verification, and System Performance Verification**

- 36585K and 36585V Precision Auto Calibrator (AutoCal) Module Reference Manual – 10410-00279
- 365xx-x Mechanical Calibration Kit Reference Manual – 10410-00278
- 366X-1 Verification Kits (3666-1 3.5mm Connectors, 3668-1 K Connectors, 3669B-1 V Connectors) and 2300-579 Performance Verification Software (PVS) User Guide – 10410-00270
- 366X-1 Verification Kit and 2300-579 PVS Quick Start Guide – 10410-00285
- 3656B W1 (1 mm) Calibration/Verification Kit and 2300-584-R System Performance Verification Software User Guide – 10410-00286
- 3659 Calibration/Verification Kit and 2300-580-R Performance Verification Software (PVS) User Guide – 10410-00327
- 3656C W1 (1 mm) Calibration/Verification Kit and Performance Verification Software User Guide – 10410-00784

## 1-7 Documentation Conventions

The following conventions are used throughout the entire MS464xB Series VNA documentation set:

### Instrument Identification

Throughout this manual, the following term definitions are used:

- VectorStar VNA refers to any VectorStar VNA instrument or system.
- VNA refers to any VectorStar standalone VNA instrument.
- MS464xB Series VNA or MS464xB Series VNA refers to the MS4642B, MS4644B, MS4645B, or the MS4647B models.
- MN469xB/C refers to the test set and software changes to convert the 2-Port VNA into a 4-Port VNA.
- ME7838x refers to VectorStar VNA systems for mmWave and/or broadband testing. ME7838x-ready refers to standalone VNAs that have the necessary internal options to later connect to the required test set and modules.
- When required to identify a specific VNA model, the specific model number is used, such as MS4647B.

<b>Note</b>	Many of the images in this document are used as typical representations of the product or of the product features. Your instrument and instrument displays may vary slightly from these images.
-------------	---

### Hard Keys or Front Panel Keys

Front panel hard keys are denoted with a bold Sans Serif font such as “Press the front panel **Frequency** key.”

### User Interface, Menus, and Soft Buttons

The VectorStar MS464xB Series VNA user interface consists of menus, button lists, sub-menus, toolbars, and dialog boxes. All of these elements are denoted with a special font, such as the CALIBRATION menu or the AutoCal button.

### User Interface Navigation

- **Previous**

The prior object such as a menu or dialog box that was used to navigate to the current object is always identified with a “Previous” cross reference line. In some cases, multiple menus can link to the same sub-menu/dialog.

- **Navigation**

Elements in navigation shortcuts or paths (identified as “Navigation”) are separated with the pipe symbol (“|”). Menu and dialog box names are distinctive Sans Serif font in CAPITALS. Button names are in Title Case. For example, the path to the AUTOCAL menu is:

- MAIN | Calibration | CALIBRATION | Calibrate | CALIBRATE | AutoCal | AUTOCAL

### User Input

User input such as entering values or other information is denoted in a mono-spaced font such as:

`This font denotes a string of user input.`

## 1-8 Operating System

The VectorStar software runs on Microsoft® Windows XP, Windows 7 (32-bit), and Windows 10 IoT (32-bit).

- Windows 7 only supports VectorStar software version 2.1.3 and higher.
- Windows 10 IoT only supports VectorStar software version 2020.5.1 and higher.

### Maintaining Operating System Integrity

The Microsoft Windows operating system on the VectorStar MS464xB Series VNA is configured for optimum performance when the instrument leaves the factory. To maintain the system's operating integrity, follow proper Windows shutdown procedures and DO NOT modify the operating system configuration, the firewall settings, the system registry, the internal drive partitions, or the Anritsu user accounts.

**Caution**

If a VectorStar VNA internal drive restore is required, contact Anritsu Customer Service.

Restoring the system software may adversely affect some user data or programs that are loaded onto the internal drive. The instrument operating system will be configured as it was on the selected restore date, including the original option configuration. Before starting the system restore procedure, back up all user data, applications, and ensure that the installation files of any additional software or instrument options are available for reinstallation.

### Antivirus Protection

The VectorStar MS464xB Series VNA is tested with most antivirus software, but stability is not guaranteed with all antivirus software. Anritsu recommends connecting the instrument only to a secure network. The user assumes the responsibility to provide virus protection because this is not supplied with the instrument. Contact your network administrator for information about your network security and antivirus protection policies.

### Windows Updates

Not all Microsoft updates are compatible with the VectorStar MS464xB Series VNA and, if installed, may affect the performance of the instrument.

**Caution**

Changing some of the default Windows settings may cause a loss of instrument control or undesired instrument behavior. Changing the Windows Regional and Language Options settings may cause unstable front panel operation. These settings must be maintained as English (United States) as is set at the factory by default.

As such, the ability of the VNA to automatically receive and install updates has been turned off. Anritsu Company recommends not allowing automatic updates from Microsoft. Ensure that the Windows update feature of the operating system remains off. Consult Anritsu customer service for procedures on how to safeguard the instrument from undesired conditions that could result from Windows updates. Updates deemed critical are available for download from the Anritsu website.



# Chapter 2 — Installation

## 2-1 Introduction


This chapter provides information for the initial inspection and preparation for use of the VectorStar MS464xB Series VNA and includes information on instrument installation, required operating environment, power requirements, and initial inspection.

After power up, the various power modes are described with general warm-up and calibration time intervals. The preventive maintenance section includes information on cleaning and fuse replacement along with preparation for storage or shipment. General set up procedures are provided for remote programming control over GPIB and Ethernet or USB only networks.

## 2-2 Unpacking the Product

### Initial Inspection

Inspect the shipping container for damage. If the container or cushioning material is damaged, retain until the contents of the shipment have been checked against the packing list and the instrument has been checked for mechanical and electrical operation. If the VectorStar MS464xB Series VNA is physically damaged, notify your local sales representative or Anritsu Customer Service. If either the shipping container is damaged or the cushioning material shows signs of stress, notify the carrier as well as Anritsu. Keep the shipping materials for the carrier's inspection.

<b>Warning</b>	
 CAUTION	
<b>&gt;18 kg</b>	
HEAVY WEIGHT	

Use two or more people to lift and move this equipment, or use an equipment cart. There is a risk of back injury if this equipment is lifted by one person.

### Preparation for Use

The VectorStar MS464xB Series VNA requires no special setup. After unpacking, the VNA is ready for use.

## 2-3 Operating Environment and Power Requirements

Before installing the VectorStar MS464xB Series VNA in its operating environment, ensure that all airflow passages at the sides and rear of the instrument are clear. Proper ventilation is of particular importance whenever the unit is being rack mounted. Keep the cooling fan filters clean so that the ventilation holes are not obstructed. A blocked fan filter can cause the instrument to overheat and shut down. The VectorStar MS464xB Series VNA can be operated within the following environmental limits:

**Table 2-1.** Operational Environmental Specifications and Power Requirements

Parameter	Specification
<b>Environmental Specifications</b>	
Operating Temperature Range:	0 to +50 degrees Celsius (per MIL-PRF-28800F)
Relative Humidity:	5% to 95% (per MIL-PRF-28800F)
Altitude:	4,600 meters, 43.9 cm Hg
Vibration:	Sinusoidal 5 Hz to 55 Hz on 3 axes
<b>Power Requirements</b>	
Voltages:	90 to 264 VAC maximum (single phase)
Frequency:	47 to 63 Hz (power factor controlled)
Power:	350 VA maximum
Installation Category:	The VectorStar MS464xB Series VNA is intended for Installation Category (Overvoltage Category) II

### Warning



or



When supplying power to this equipment, connect the accessory 3-pin power cord to a 3-pin grounded power outlet. If power is supplied without grounding the equipment, there is a risk of receiving a severe or fatal electric shock.



## 2-4 Power-On/Power-Off Procedures

The power-on procedure involves connecting the instrument to AC Mains, using the back panel **AC Power Rocker Switch** to turn the instrument on, and then using the front panel **Standby/Operate key** to toggle the instrument into operate mode. The power-off procedure involves using the front panel **Standby/Operate key** to toggle the instrument into standby mode, and then using the back panel **AC Power Rocker Switch** to turn the instrument off.

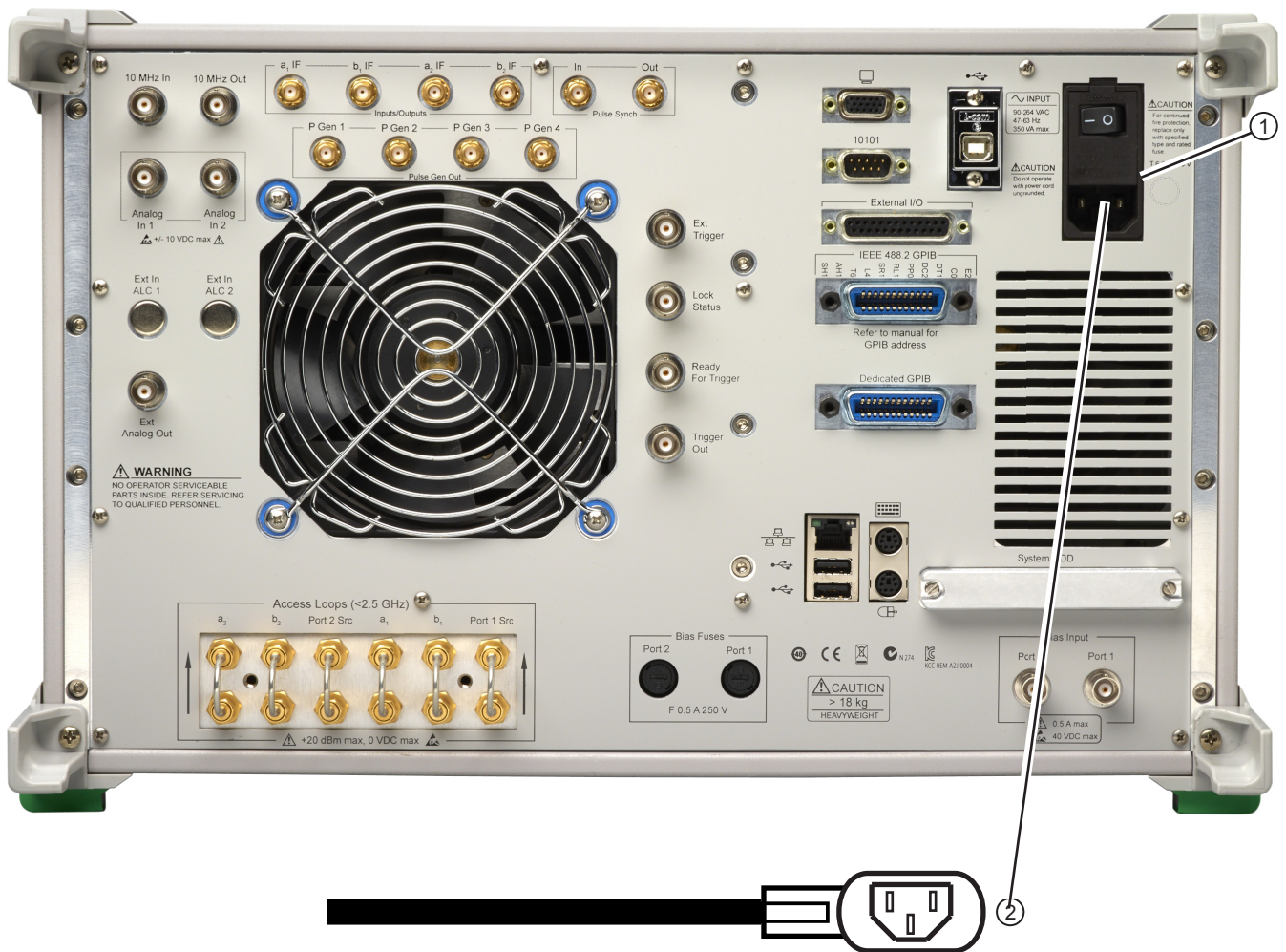
During the transition from operate to standby, first the **green Operate LED** blinks and then the **orange Standby LED** blinks. Finally, the **Standby LED** stops blinking and goes into a steady state of illumination.

**Note**

Do not turn the instrument off or unplug it while it is changes from standby to operate, or from operate to standby.

Do not turn the instrument off or unplug it when it is in operate mode.

Doing so may cause the Windows application to improperly close.



1. The AC Power Entry Module contains the rear panel AC Power Rocker Switch (at top) and the IEC C14 AC Power Socket (m) (at bottom).

2. The AC Mains Connection is made with an AC Input Cable connected to local AC mains power at one end and to the instrument using the IEC C13 AC Line Socket at the other end.

**Figure 2-1.** Rear Panel Power Connection to AC Mains Power

## Procedure – Power-On to Standby Mode

To turn the instrument on:

1. Connect the supplied AC power cord to local AC mains power.
2. Connect the other end of the power cord to the rear panel **IEC C14 Chassis AC Power Socket** located in the upper right corner of the rear panel.
3. Switch the instrument on by changing the **AC Power Rocker Switch** to “I” (or **ON**). The orange **Standby LED** illuminates. The instrument is now in standby mode.

**Note**

Whenever the VNA is not being used, it should be left connected to the power source and placed in standby mode. This keeps the internal time-base frequency reference at the correct operating temperature.

When the instrument is in standby mode, it is safe to turn it off from the rear panel **AC Power Rocker Switch**.

After turning off the instrument, you must wait at least 15 seconds before turning the instrument back on again. This delay is required to allow the internal power supplies to discharge and to assure a reliable cold start.

## Procedure – Standby Mode to Operate Mode

To set the instrument to operate mode:

1. Press and hold the front panel **Standby/Operate key** for at least one second. The orange **Standby LED** turns off and the green **Operate LED** illuminates. The VectorStar VNA information splash screen is displayed during the change to operate mode process and is shown below in [Figure 2-2, “VectorStar MS464xB Series VNA Startup Splash Screen”](#).

**Note**

The VectorStar MS464xB Series VNA requires at least two minutes to load the system software and perform a series of internal calibrations. The system uses a self-test to check all sub-systems for proper operation and download firmware into the various peripheral devices.

2. When fully in operate mode, the VectorStar MS464xB Series VNA displays the main channel and trace display with the application menus on the right side. See [Figure 4-1, “User Interface - Single Channel - Four Traces - Frequency Menu”](#) for a typical full screen display.

**Note**

When the instrument is in operate mode, do not use the rear panel **AC Power Rocker Switch** to turn off the instrument nor disconnect the instrument from the AC power. Doing so will cause the Windows application to close improperly.

When placing the VectorStar MS464xB Series VNA in operation, allow at least 90 minutes of warm-up time in the operate mode before using the VNA to assure stable operation and the highest possible accuracy.



**Figure 2-2.** VectorStar MS464xB Series VNA Startup Splash Screen

### Procedure – Operate Mode to Standby Mode

To set the instrument to standby mode from operate mode:

1. Press and hold the front panel **Standby/Operate key** for at least one second. The green **Operate LED** blinks and then the orange **Standby LED** blinks. The instrument switches from operate mode to standby mode.
2. When fully in standby mode, the orange **Standby LED** is illuminated and is not blinking.

**Note**

Do not disconnect the instrument from power nor turn off with the **AC Power Rocker Switch** while the instrument is changing from operate mode to standby mode.

## Procedure – Standby Mode to Power-Off

To turn the instrument off:

1. Make sure that the instrument is in standby mode. The orange **Standby LED** should be illuminated and not blinking.
2. Turn off the instrument by pressing the “**O**” (or **OFF**) on the rear panel **AC Power Rocker Switch**.
3. If necessary, the instrument can now be disconnected from the AC power mains.

<b>Note</b>	After turning off the instrument, you must wait at least 15 seconds before turning the instrument back on again. This delay is required to allow the internal power supplies to discharge and to assure a reliable cold start.
-------------	--

## 2-5 Connecting External Devices

After unpacking, the VectorStar MS464xB Series VNA ready for use although it is strongly recommended that you connect an external keyboard and mouse to facilitate ease of use of the VectorStar VNA application and operating system. The VNA also supports the connection of an XGA/VGA monitor, printer, and many other Windows-based peripherals. In general, most peripherals are rated as plug-and-play with no driver installation or further configuration required.

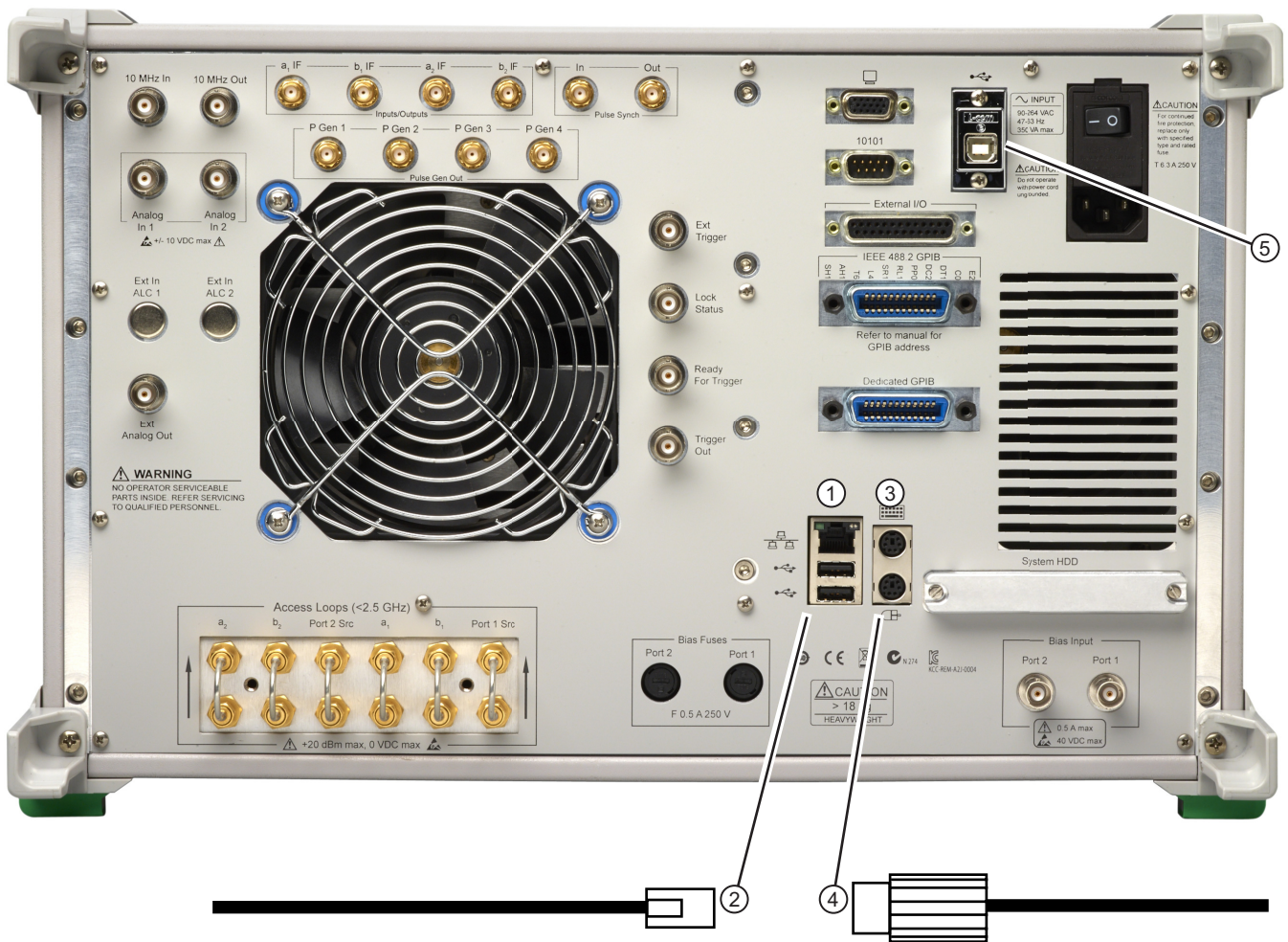
### Connecting an External Mouse or Keyboard

The VNA provides USB Type A and PS/2 DIN connector ports for external keyboard and mouse interfaces. USB Type A connectors are available on both the front and rear panels; PS/2 connectors are only available on the rear panel. If the USB Type A connectors are needed for other devices, a USB keyboard/mouse can be connected through the PS/2 connector by using a user-provided USB to PS/2 adapter connector.

When connecting either a keyboard and/or mouse, ensure that the instrument is set to standby mode before connecting them. When the VectorStar MS464xB Series VNA is set to **Operate**, the keyboard and mouse should be automatically detected by the operating system and be ready for use. To use any advanced features of your external keyboard and mouse, follow the manufacturers installation instructions.

<b>Note</b>	A USB mouse may require a hot connection while the instrument is in the <b>Operate</b> mode with the VectorStar VNA Application software running. If a USB mouse fails to operate when the instrument is started with the mouse plugged into the USB port, reboot the instrument with the mouse disconnected and make the hot connection after the VectorStar VNA Application software is running.
-------------	--





- |  |   |
|--|---|
| <p>1. Rear Panel USB Type A Ports – Also two Type A Ports on Front Panel.</p> <p>2. USB Cable.</p> <p>3. Rear Panel PS/2 Port.</p> | <p>4. PS/2 Cable.</p> <p>5. USB Type B Control Port – For VNA control over a USB network.</p> |
|--|---|

**Figure 2-3.** Rear Panel Keyboard and Mouse Connections

**Note** Advanced keyboard and mouse features may not be supported in the analyzer application, but should function as expected in the Windows environment.

There are two rear panel USB 2.0 Type A Ports (also two on front panel) that can be used for USB connections for a USB mouse or keyboard. In addition, there are two rear panel PS/2 Ports with Mini-DIN (f) connectors for keyboard (top) and mouse (bottom) connections using a PS/2 Mini-DIN (m) connector and cable.

### Connecting an External XGA/VGA Monitor

The rear panel **XGA/VGA Video Port** external monitor interface is a standard XGA/VGA DB-15 Mini-DIN (f) connector. When connecting an external monitor, ensure that the instrument is in standby mode and that the monitor is disconnected from its power source. Once the monitor is connected, turn on its power and then set the VNA to Operate. The monitor should be automatically detected by the operating system and be ready for use.

## Connecting an External Printer

The external printer interface is typically connected through an available front or rear panel **USB Type-A Port**. Many printers will be recognized by the Windows operating system and require no further installation.

If installation and configuration is required, install your printer driver according to the manufacturer's directions. The hardware connection should be made when the VNA is in **Standby** or **Off** mode to allow for proper initialization of the hardware during boot-up of the operating system.

If you attempt to print from the VNA application before a printer is installed, a dialog box appears prompting you to install a printer.

## Connecting Other USB Peripherals

Use any available USB 2.0 Type A Port for connecting other USB devices such as a scanner, external drive, camera, or USB memory device (a "memory stick"). The USB interface offers the same behavior that is typically experienced in the Windows operating system environment.

If connection of multiple USB devices is considered, the use of a user-supplied powered USB hub is recommended. If the USB Type A Ports are required for other devices, an attached USB keyboard and/or USB mouse can be attached to the rear panel **Keyboard/Mouse PS/2** ports by using a user-supplied **USB to PS/2 Adapter**.

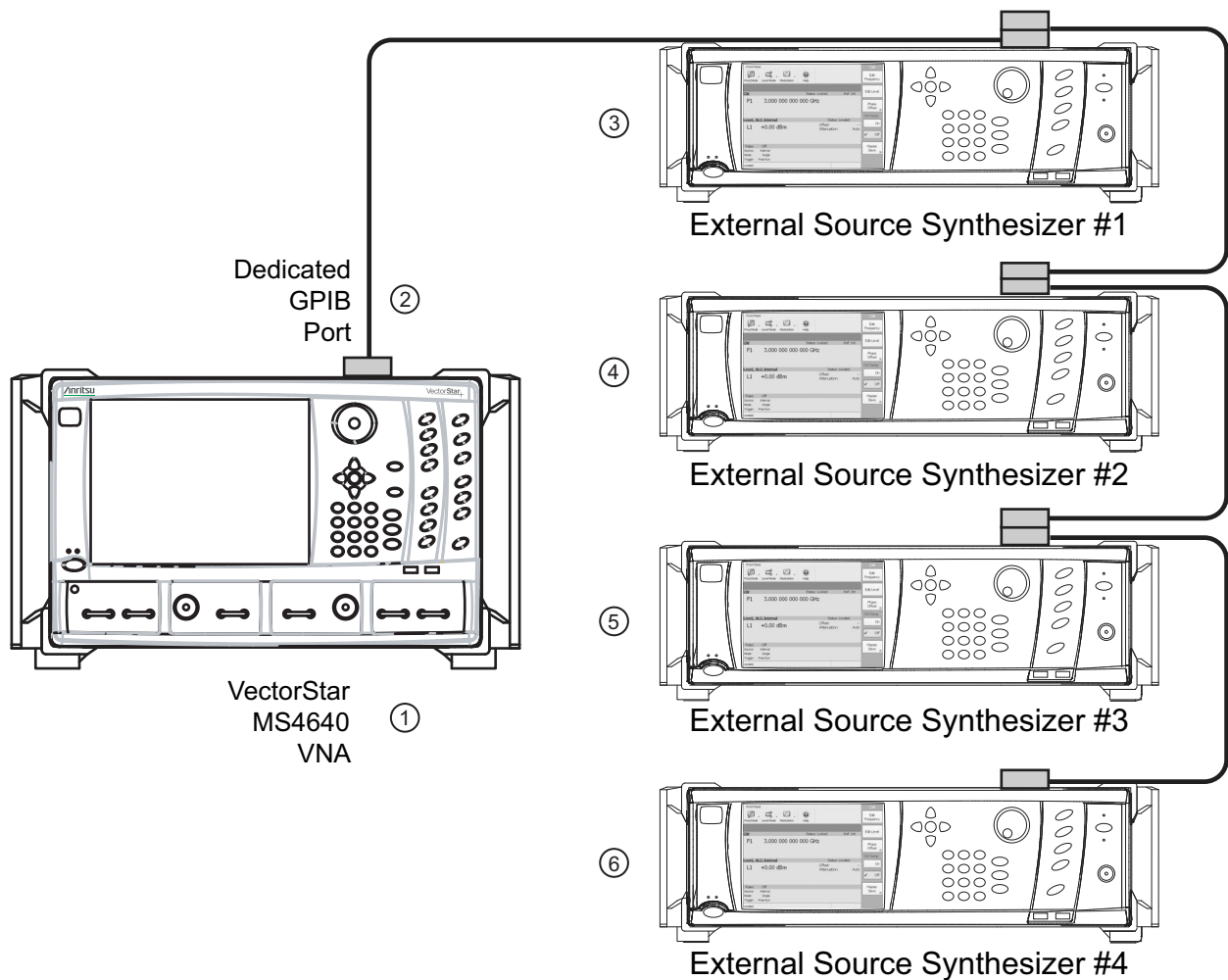
## 2-6 GPIB Setup

The interface between the VectorStar MS464xB Series VNA and other devices on the GPIB is via a standard 24-wire GPIB interface cable. This cable uses a double-sided connector where one connector face is a plug and the other a receptacle. These double-function connectors allow parallel connection of two or more cables to a single instrument connector.

**Caution** When two or more cables are connected in parallel, do not bend the attached connectors as this could damage the rear panel GPIB Port connector.

### Configuring the Dedicated GPIB Port

Use this procedure to set up the dedicated GPIB port to control other GPIB devices such as Power Meters or Signal Generators by using the VNA rear panel **Dedicated GPIB Port**. An example of a complex GPIB configuration with the VNA as the GPIB controller is shown in [Figure 2-4](#).

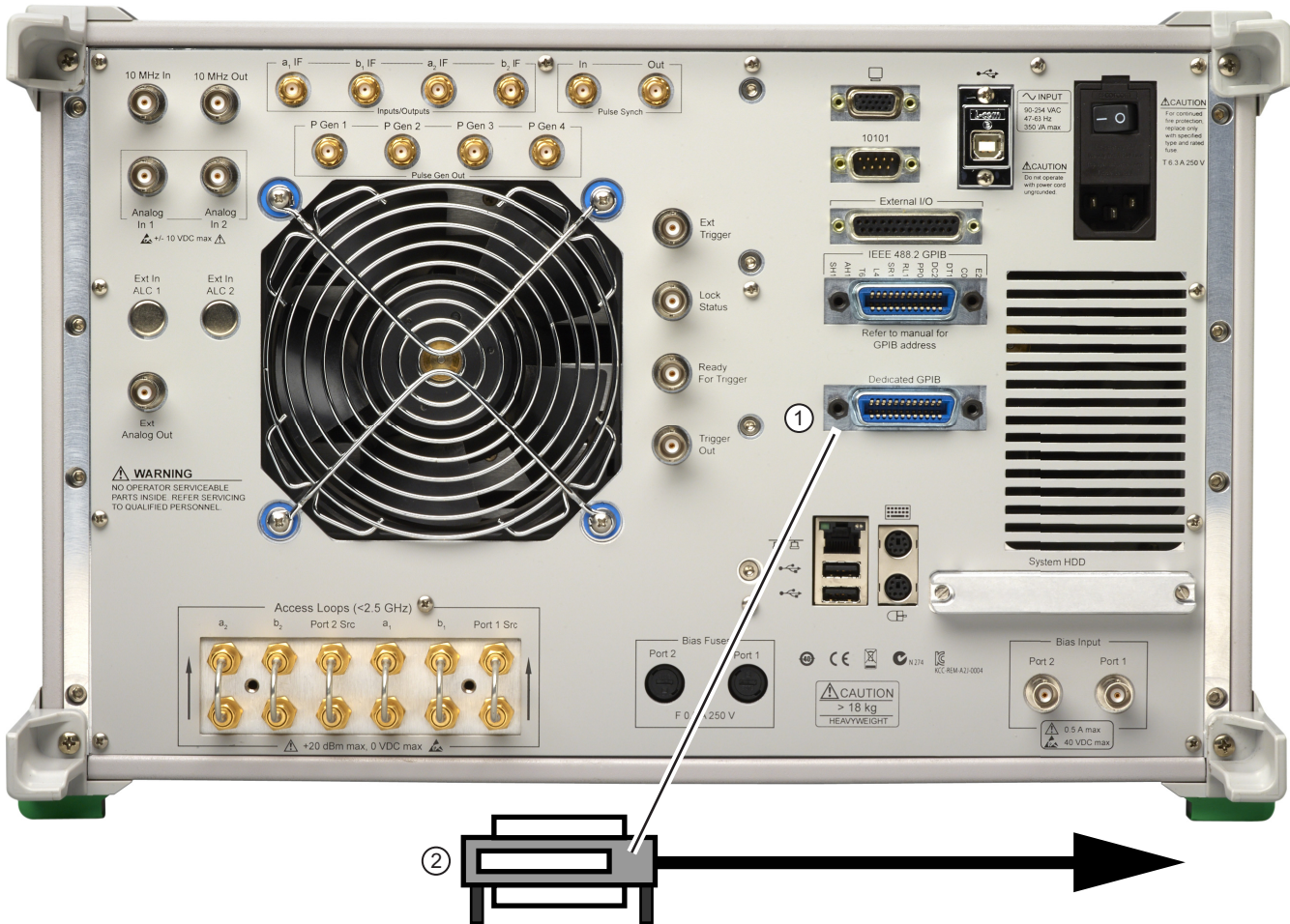


- |  |  |
|--|--|
| 1. VectorStar MS464xB Series VNA.                    | 4. Synthesizer GPIB address 5 as External Source #2. |
| 2. Rear Panel Dedicated GPIB Port and GPIB Cable.    | 5. Synthesizer GPIB address 2 as External Source #3. |
| 3. Synthesizer GPIB address 4 as External Source #1. | 6. Synthesizer GPIB address 3 as External Source #4. |

**Figure 2-4.** VNA as a Remote GPIB Controller for Synthesizers



1. Connect GPIB devices to the VNA rear panel **Dedicated GPIB Port** using the appropriate length GPIB cable.

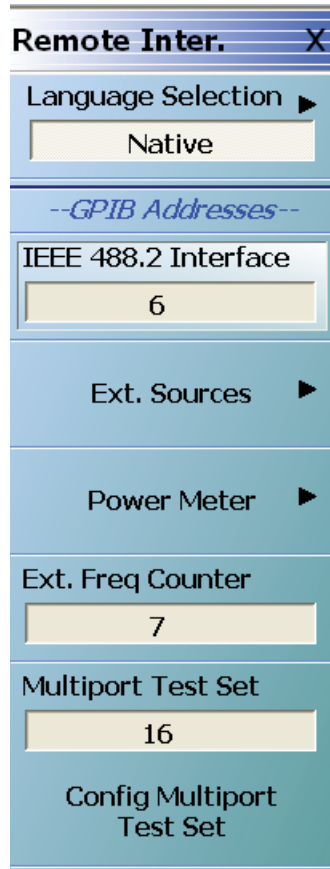


- |  |   |
|--|---|
| <ol style="list-style-type: none"> <li>1. Rear Panel Dedicated GPIB Port for control of connected external sources, power meters, and frequency counters.</li> </ol> | <ol style="list-style-type: none"> <li>2. GPIB Cable Connection to peripheral devices.</li> </ol> |
|--|---|

**Figure 2-5.** VectorStar MS464xB Series VNA Dedicated GPIB Port

2. Power-up the VectorStar MS464xB Series VNA and any attached GPIB devices, and allow the system to warm up for at least 90 minutes.
3. Navigate to the REMOTE INTER menu:
  - MAIN | System | SYSTEM | Remote Interface | REMOTE INTER.
  - [Figure 2-6, “REMOTE INTER \(REMOTE INTERFACE\) Menu” on page 2-11](#)
  - A detailed menu description is located in the **User Interface Reference Manual**.

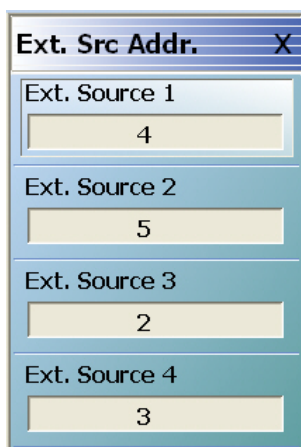




<p>On the REMOTE INTER. (REMOTE INTERFACE) menu: The IEEE 488.2 Interface, Ext. Sources, Ext. Power Meter, Ext. Freq Counter, and the Multiport Test Set buttons control GPIB addresses for the subject devices.</p>	<p>The Ext. Sources button displays the EXT. SRC. ADDR. menu where GPIB addresses are assigned for external source 1 through external source 4.</p> <p>The Power Meter button displays the POWER METERS menu where GPIB addresses are assigned for External, W-Band, and D-Band power meters source.</p>
--	--

**Figure 2-6.** REMOTE INTER (REMOTE INTERFACE) Menu

4. The GPIB address for any controlled device can be kept at the factory default values or changed as required. The default GPIB addresses are:
  - External Source 1 = 4
  - External Source 2 = 5
  - External Source 3 = 2
  - External Source 4 = 3
  - Power Meter (External) = 13
  - Power Meter (W-Band) = 15
  - Power Meter (D-Band) = 17
  - Power Meter (G-Band) = 18
  - Power Meter (110 GHz broadband) = 20
  - Frequency Counter = 7
  - Multiport Test Set = 16
    - Only available when a MN4694C or MN4797C Multiport/4-Port Test Set is installed.
    - The test set must be on and the VNA must be rebooted for any GPIB address change to take effect.
    - See the VectorStar **MN469xC Multiport Test Set Installation Guide** for complete installation and configuration instructions.
  - The VectorStar instrument itself = 6
5. The GPIB addresses for the External Sources are changed on the EXT. SRC ADDR. (EXTERNAL SOURCE ADDRESS) sub-menu shown below in [Figure 2-7](#).
  - MAIN | System | SYSTEM | Remote Interface | REMOTE INTER. | Ext. Sources | EXT. SRC. ADDR
  - A detailed description of the menu is available in the **User Interface Reference Manual**.



**Figure 2-7.** EXT. SRC. ADDR. (EXTERNAL SOURCE ADDRESS) Menu

6. If a change of GPIB address is required, click the device button, and the device field toolbar appears as shown below:



7. Use the front panel keys, a keyboard, or mouse to set the required GPIB address.
8. Click the Enter button to set the new GPIB address.

For information on the programming command sets, refer to the *VectorStar MS464xB Series VNA Programming Manual*.

- 9. The GPIB addresses for Power Meters are changed on the POWER METERS sub-menu shown below in [Figure 2-8](#).
  - MAIN | System | SYSTEM | Remote Interface | REMOTE INTER. | Power Meter | POWER METERS.

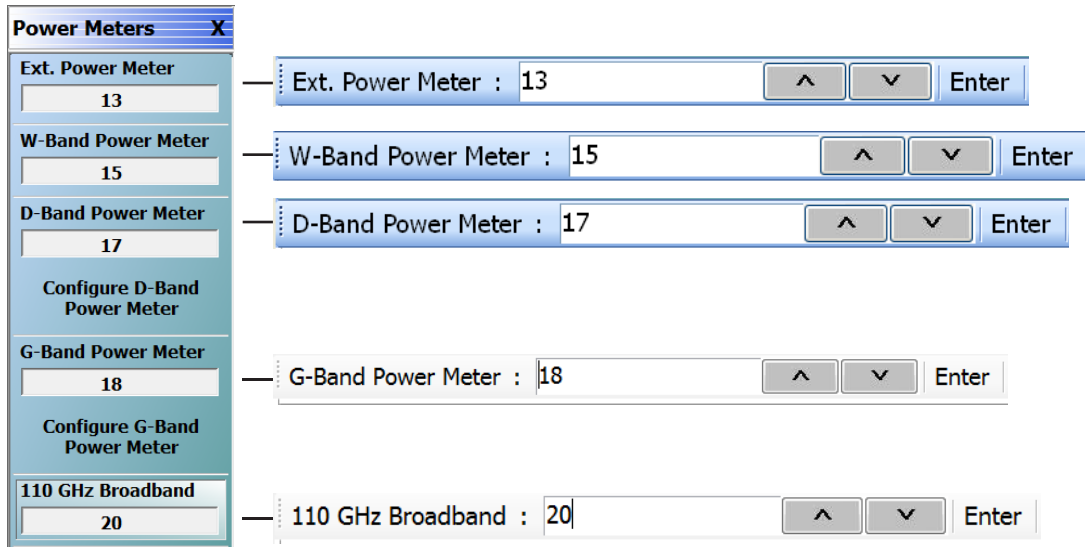
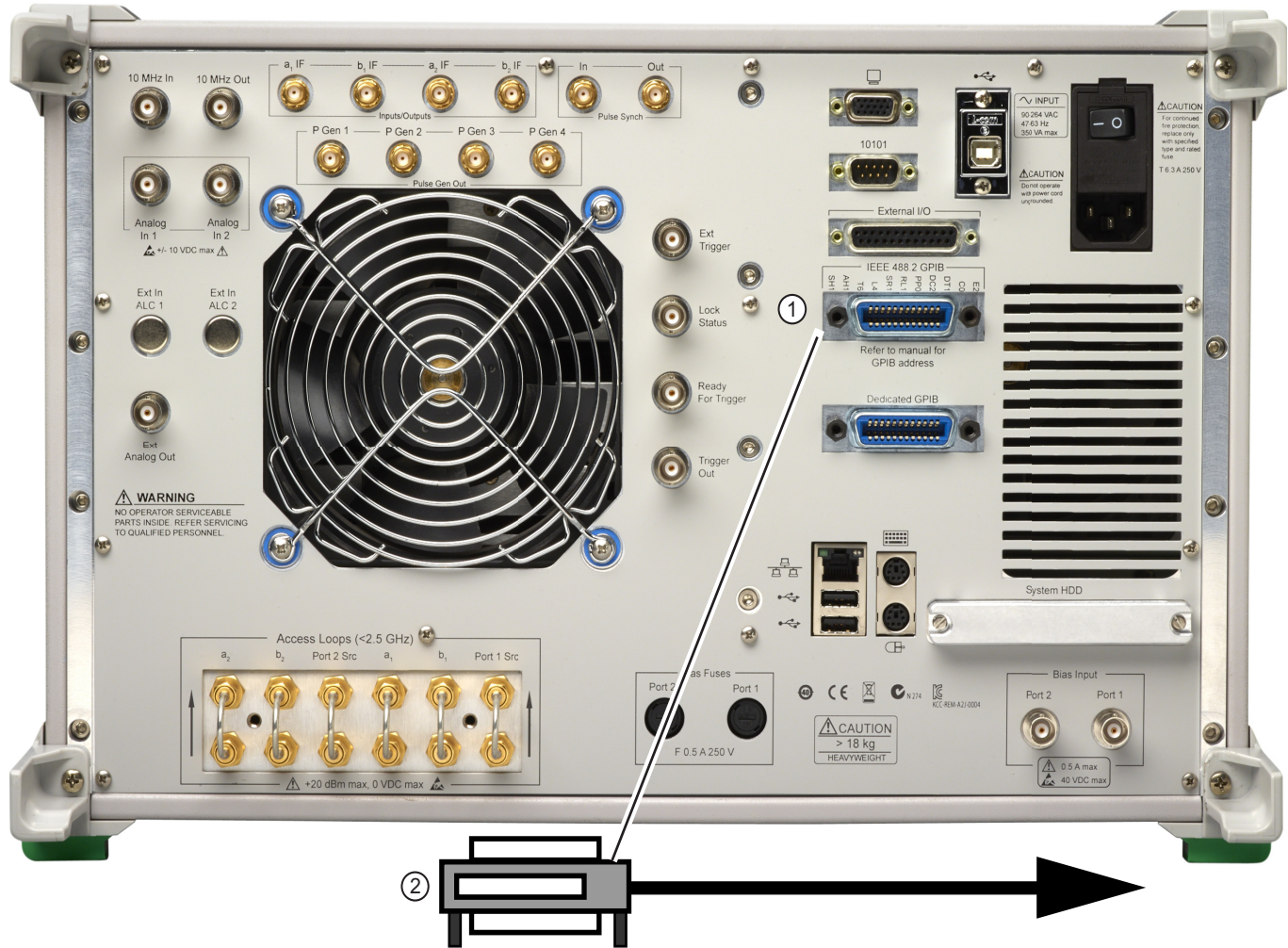


Figure 2-8. Power Meters Menu

## Configuring the IEEE 488.2 GPIB Port

Use this procedure to set up the talker/listener port to control the VNA remotely over an IEEE 488.2 GPIB bus network. In this configuration, an external computer/controller is physically connected to the VNA rear panel **IEEE 488.2 GPIB Port** with a standard GPIB cable. Most of the VectorStar MS464xB Series VNA functions (except power on/off and initialization of the internal drive) can be controlled remotely by an external computer/controller via the IEEE-488.2 GPIB bus network.

1. Connect the VNA to the GPIB Controller using the rear panel **IEEE 488.2 GPIB Port** DB-24 (f) connector and a standard GPIB cable.



1. IEEE 488.2 (Upper) Port

2. GPIB Cable Connection. Note that the Dedicated GPIB Port is not used in this configuration.

**Figure 2-9.** IEEE 488.2 GPIB Talker/Listener Ports

2. Apply power to the VectorStar MS464xB Series VNA and allow the system to warm up for at least 90 minutes.
3. Once the software has finished loading and start-up testing is complete, the instrument is ready to be remotely controlled via the GPIB. The instrument will not respond to GPIB commands until the instrument's software has been loaded.

**Note** The factory default GPIB address for the instrument is six (6).

## Configuring the VectorStar VNA GPIB Address

To change the VectorStar VNA GPIB address:

1. Navigate to the REMOTE INTER. menu:
  - MAIN | System | SYSTEM | Remote Interface | REMOTE INTER.
2. On the REMOTE INTER menu, the IEEE 488.2 GPIB button.

The IEEE 488.2 GPIB toolbar appears below the icon toolbar near the top of the display.



3. Use the front panel keys, a keyboard, or a mouse to set the required GPIB address.
4. Click the Enter button to set the new GPIB address.

For information on the programming command sets, refer to the:

- **VectorStar MS464xB Series VNA Programming Manual**
- **VectorStar MS464xB Series VNA Programming Manual Supplement**

## 2-7 Ethernet LAN TCP/IP and USB Setup

The VectorStar MS464xB Series VNA supports Ethernet 10/100 BASE-T. The instrument is connected directly to the LAN via the rear panel RJ-45 Ethernet Port using a standard CAT-5 Ethernet cable. The MS464xB Series VNA VNAs can also be controlled remotely across a Universal Serial Bus (USB) Type 2 network by a PC equipped with a USB control application using the rear panel **USB Control Port**.

### Default Plug-and-Play Configuration

The VectorStar MS464xB Series VNA and its Windows operating system comes pre-configured and ready to plug into and connect with an existing Ethernet or USB network. The Ethernet network must provide DNS/DHCP and be configured with a gateway. USB networks are typically auto-detecting without the need for configuration; however, a special USB network cable (described in the note below) is required.

**Note**

The required PC-to-Instrument USB 2.0 networking cable (also called a USB-USB cable, USB networking cable, or USB bridge cable) has a small electronic circuit module in the middle of the cable that allows the PC and the VectorStar VNA to talk to each other at 480 Mbps. The PC-to-Instrument USB cable is user-provided and does not come with the VectorStar MS464xB Series VNA VNA.

Using the wrong type of USB-USB cable can result in damage to the PC and/or VectorStar USB ports and/or power supplies. Do NOT use a so-called "USB A / A" cable that is similar to a serial port cross-over null-modem cable.



Connect the VNA to the network with an Ethernet cable between the VNA rear panel **RJ-45 Ethernet Port** and your local network port or a USB network cable between the VNA rear panel **USB Type 2 Port** and your local network hub.



- |   |   |
|---|---|
| 1. Rear Panel Ethernet Port (at top) and USB Ports (at bottom). | 2. Matching USB or Ethernet Connection Cable. |
|---|---|

**Figure 2-10.** VectorStar MS464xB Series VNA Ethernet and USB Ports

The VectorStar MS464xB Series VNA has one **Ethernet RJ45 (f) connector** and two (2) with **USB 2.0 Type A port connectors**. There are two additional **USB 2.0 Type A ports** on the instrument front panel. Use the Ethernet port to connect to a LAN (Local Area Network). Windows will automatically detect the network settings and configure the network connection.

## Manually Configuring TCP/IP Ethernet LAN Settings

**Note**

This section is provided for general information about manually configuring an Ethernet connection and does not apply to USB networking. Consult your local network administrator for the exact requirements and settings that are required for your network installation.

To see the current network settings for your VectorStar MS464xB Series VNA, with the VectorStar Application Software running, navigate to the NETWORK INTERF. (Network Interface) menu as follows (see [Figure 2-11](#)):

- MAIN | System | SYSTEM | Ntwk Interface | NETWORK INTERF.

The detailed description of the menu, its operation, and connected dialog boxes are described in the **User Interface Reference Manual**.



**Figure 2-11.** NETWORK INTERF. (NETWORK INTERFACE) Menu

The top eight (8) display buttons provide information for the current network settings. Changes to these settings must be made through the Microsoft Windows configuration utilities by clicking **Network Connections**.

The **Network Connections** dialog box shows the current available local networks.

**Note**

You may need to consult your network documentation or network administrator for assistance in manually configuring your network setup. The Windows network connections Help may provide information related to computer networking.



## 2-8 Configuring the Remote Language

The VectorStar MS464xB Series VNA command parser responds to either Native SCPI commands or to the legacy Anritsu Lightning-model command set. The MS464xB VNAs also support many HP/Agilent 8510 programming commands.

Regardless of the setting, the MS464xB VNA parser will respond to commands from either source.

Scripts written in older versions of the Lightning command set or in the HP/Agilent 8510 command set may need editing to be fully compatible with the VNA. Not all Lightning and HP/Agilent commands are supported.

Processing and response times will be improved if the Remote Language setting matches the majority of the sent commands.

If necessary, you can change the VNA default GPIB language from Native to Lightning or HP/Agilent 8510x as follows:

1. Navigate to the Remote Lang. menu:
  - This menu is described in greater detail in the **User Interface Reference Manual**.
  - MAIN | System | SYSTEM | Remote Interface | REMOTE INTER. | Language Selection | REMOTE LANG.



**Figure 2-12.** REMOTE LANG. (REMOTE LANGUAGE) Menu

2. Select the interface language being used.
3. The menu auto-returns to the REMOTE INTER menu.

## 2-9 Calibration/Verification Interval

If the VectorStar MS464xB Series VNA requires service or calibration, the system may be returned to factory specifications and re-imaged with a standard software configuration. User installed applications and data may be lost and unable to be retrieved. It is advised that user data be backed up, copied, and retained by the user. Applications will need to be reinstalled from their original installation disks. A complete system restore from a previous user backup is not advised after service or calibration as this will result in the new calibrations being overwritten, thus voiding the calibration accuracy.



# Chapter 3 — Front and Rear Panels

## 3-1 Chapter Overview

The chapter provides an overview of the MS464xB Series VNA hardware user interface including front panel buttons, front panel connectors, and back panel connectors. Included are photographs of the front and rear panels. Each front panel key is described with its function and a cross reference to the menu it activates on the user interface display. Each port and connector is described with its connector type, its function, input/output limits, and a cross-reference to a detailed connector pin-out diagram.

## 3-2 Front Panel Touch Screen

The touch screen display shows the instrument measurement graphs and the system navigation menus. The menus are available by using either the touch screen or a connected mouse and keyboard. A complete description of the various display and menus appears in the chapters below.

When using the touch screen, a recommended best practice is to use a positive hard press to make sure the required setting is input into the system. A light touch may not change the instrument setting as required.

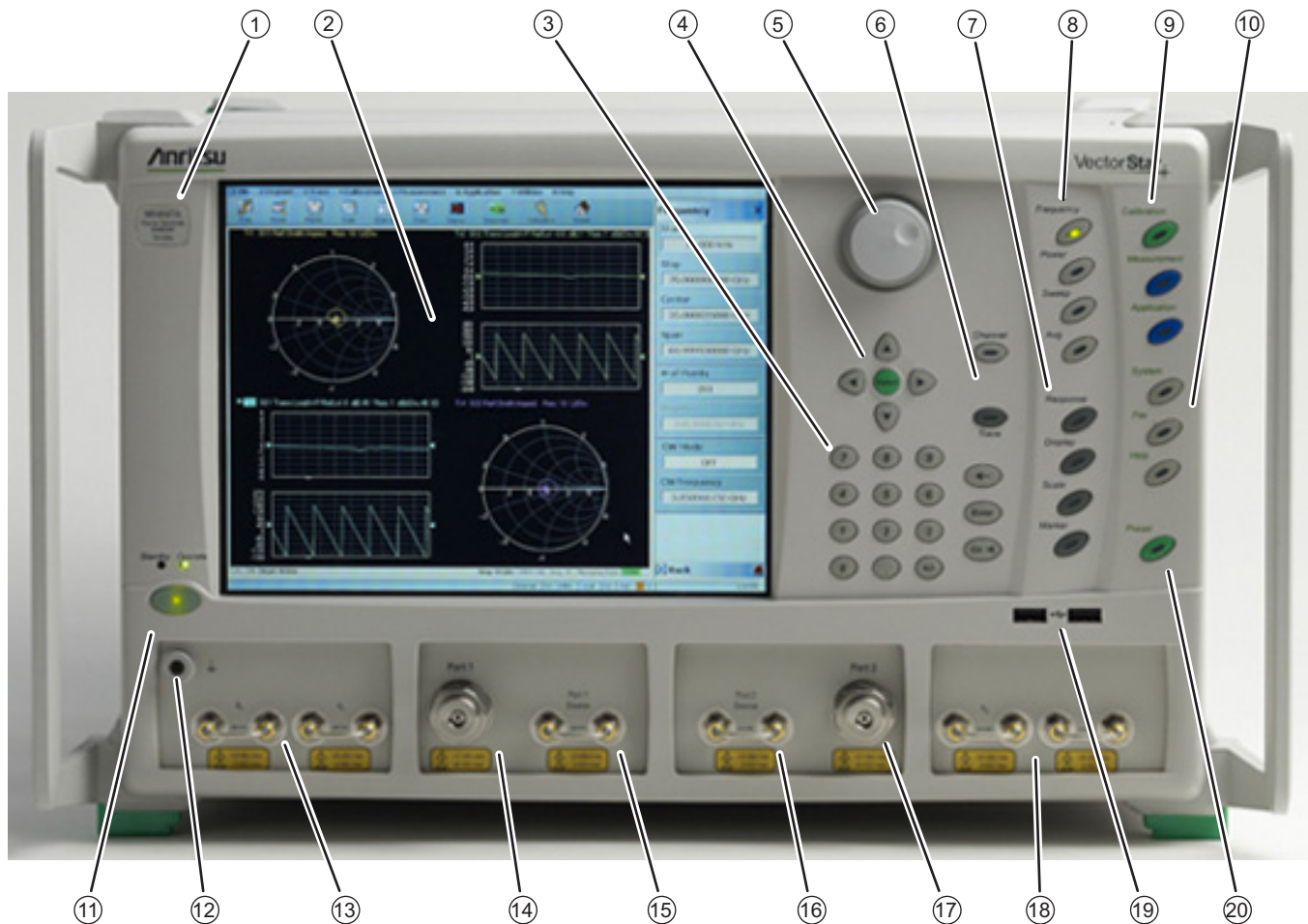
**Note**

To recalibrate the touch screen, navigate to the CALIBRATE TOUCH SCREEN dialog box located at **MAIN | System | SYSTEM | Utility | UTILITY | Calibrate Touch Screen | TOUCH SCREEN CONTROL PANEL dialog box**. The procedure is described in the **User Interface Reference Manual**.

A more detailed touch screen calibration and adjustment procedure is described in the **VectorStar MS464xB Series VNA Maintenance Manual**.

### 3-3 Front Panel Hard Keys and Connectors

The MS464xB Series VNA front panel areas, keys, and port connectors are identified below in [Figure 3-1](#).



Note: Changing the installed location of the front panel Direct Access Loops (13), (15), (16), and (18) results in changes to the display of the factory RF calibration due to the differing electrical lengths of the loops. Changing locations of these loops have no effect on user RF calibrations.

**Figure 3-1.** MS464xB Series VNA Front Panel Hard Keys and Connectors (1 of 2)

<ol style="list-style-type: none"> <li>1. ID Plate – Instrument model number identification</li> <li>2. Display Area – Touch screen with instrument test results and graphics with the MENU BAR at top and the ICON BAR immediately below. The MAIN menu with access to specific-functions menus and dialog boxes is on the right side. This area is also terms the right-side application menus.</li> <li>3. Data Entry – Data entry keypad with numbers from 0 (zero) to 9 (nine), Decimal Point, and +/- (Plus/Minus).</li> <li>4. Navigation Keys – Up, Down, Left, Right arrow navigation keys and the center Select key.</li> <li>5. Rotary Knob – Scrolls through values or changes settings. Pressing it is the same function as the Select key.</li> <li>6. Channel Key – Select displays the Channel menu.</li> <li>7. Analysis Key Group – Response, Display, Scale, and Marker Keys. Select of each displays the named menu.</li> <li>8. Setup Key Group – Power, Sweep, and Avg Keys. Select of each displays the named menu.</li> <li>9. Measurement Key Group – Calibration, Measurement, and Application Keys</li> <li>10. System Key Group – System, File, and Help keys</li> </ol>	<ol style="list-style-type: none"> <li>11. Standby/Operate Key – Pressing and holding the key for more than one (1) second toggles the VNA between standby and operate modes. When in standby mode, the orange Standby LED above the key is illuminated. When in operate mode, the green Operate LED above the key is illuminated.</li> <li>12. Ground – Chassis Ground Port Banana connector</li> <li>13. Direct Access Loops – b1 Front Panel Direct Access Loop (left) and a1 Front Panel Direct Access Loop (right).</li> <li>14. Test Port 1 – K (f) on MS4642B, MS4644B, and MS4645B VNAs – V (f) on MS4647B VNAs.</li> <li>15. Port 1 Direct Access Loop – Port 1 Source Front Panel Direct Access Loop</li> <li>16. Direct Access Loop – Port 2 Source Front Panel Direct Access Loop</li> <li>17. Test Port 2 – Same connector types as for Test Port 1 above.</li> <li>18. Direct Access Loop – a2 Front Panel Direct Access Loop (left) – b2 Front Panel Direct Access Loop (right)</li> <li>19. USB Ports – Two USB 2.0 Type A Ports</li> <li>20. Preset Key – The Preset key restores the instrument to one of three prior states. User Defined: A previously saved user-defined state. Default: The factory as-shipped state. Default 0: The factory original setting. The user selects which preset mode is used.</li> </ol>
--	---

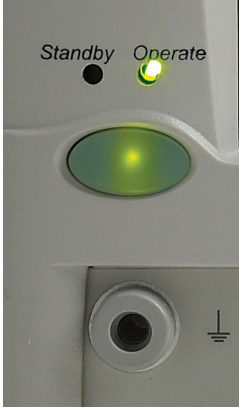
**Figure 3-1.** MS464xB Series VNA Front Panel Hard Keys and Connectors (1 of 2)

**Note** Changing the installed location of the front panel Direct Access Loops (13), (15), (16), and (18) results in changes to the display of the factory RF calibration due to the differing electrical lengths of the loops. Changing locations of these loops have no effect on user RF calibrations.

## Front Panel Hard Key and Connector Description

The front panel hard keys are described in [Table 3-1](#) below. The cross reference links are to related information in this chapter and detailed menu descriptions in separate chapters

**Table 3-1.** Front Panel Hard Keys and Functions (7 of 8)

Key Name	Primary Functions
<b>Power Key and Chassis Ground Connector</b>	
	
<b>Standby/Operate Key</b>	<p>Pressing and holding the Standby/Operate key for at least one (1) second toggles the VNA between operate mode and standby mode.</p> <p><b>Power Up</b></p> <p>To power up the VNA into Standby mode, connect the instrument to AC power and then set the rear panel AC Power Rocker Switch (which is part of the upper right corner AC Power Input Module) to “I” or ON. The orange Standby LED on the front panel is illuminated and the Standby/Operate key is illuminated with an orange LED.</p> <ul style="list-style-type: none"> <li>• <a href="#">“AC Power Connectors and Controls” on page 3-14</a> below.</li> </ul> <p><b>Standby to Operate Mode</b></p> <p>With the VNA in standby mode, to change to operate mode, press and hold the Standby/Operate key for at least one (1) second. The green Operate LED is illuminated and the Standby/Operate key is illuminated with a green LED.</p> <p><b>Operate to Standby Mode</b></p> <p>With the VNA in operate mode, to change to standby mode, press and hold the Standby/Operate key for at least one (1) second. The orange Standby LED is illuminated and the Standby/Operate key is illuminated with an orange LED.</p> <p><b>Power Off</b></p> <p>With the VNA in standby mode, to remove AC power from the VNA and turn the VNA off, set the rear panel AC Power Rocker Switch to “O” or OFF.</p> <p>Do not remove AC Power from the VNA while it is in operate mode. Do not turn off the VNA while it is in operate mode.</p>
<b>Chassis Grounding Port</b>	<p>Provides an instrument chassis and signal grounding (earth) point.</p> <p>Banana (f).</p>

**Table 3-1.** Front Panel Hard Keys and Functions (7 of 8)

Key Name	Primary Functions
----------	-------------------

**Calibration, Measurement, and Application Keys**



<b>Calibration Key</b>	Pressing <b>Calibration</b> displays the user interface CALIBRATION menu. <ul style="list-style-type: none"> <li>• MAIN   Calibration   CALIBRATION</li> </ul>
<b>Measurement Key</b>	Pressing <b>Measurement</b> displays the MEASUREMENT menu in the user interface display. <ul style="list-style-type: none"> <li>• MAIN   Measurement   MEASUREMENT</li> </ul>
<b>Application Key</b>	Pressing <b>Application</b> displays the APPLICATION menu in the user interface display. <ul style="list-style-type: none"> <li>• MAIN   Application   APPLICATION</li> </ul>

**System, File, Help, and Preset Keys**

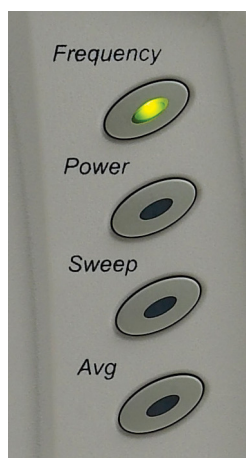


<b>System Key</b>	Pressing <b>System</b> displays the System menu in the user interface display. <ul style="list-style-type: none"> <li>• MAIN   System   SYSTEM</li> </ul>
<b>File Key</b>	Pressing <b>File</b> displays the File menu in the user interface display. <ul style="list-style-type: none"> <li>• MAIN   File   FILE</li> </ul>
<b>Help Key</b>	Pressing <b>Help</b> displays the Help menu in the user interface display. <ul style="list-style-type: none"> <li>• MENU BAR   Help   Context Sensitive Help</li> </ul>

Table 3-1. Front Panel Hard Keys and Functions (7 of 8)

Key Name	Primary Functions
<b>Preset Key</b>	<p>Returns the instrument (or presets it) to the last active configuration preset loaded as defined and set in the PRESET SETUP menu. Depending on the user-set preset configuration, this can be either:</p> <ul style="list-style-type: none"> <li>• User Defined: A previously saved user-defined state.</li> <li>• Default: The factory as-shipped state.</li> <li>• Default 0: The factory original setting.</li> </ul> <p>The user selects which preset mode is used.</p> <ul style="list-style-type: none"> <li>• MENU BAR   Utilities   Preset</li> <li>• MAIN   System   SYSTEM   Setup   SETUP   Preset Setup   PRESET SETUP</li> </ul>

### Frequency, Power, and Sweep Setup Key Group



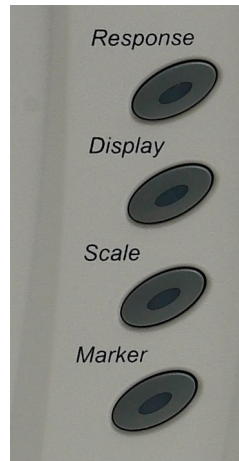
<b>Frequency Key</b>	<p>Pressing <b>Frequency</b> displays the FREQUENCY menu in the user interface display.</p> <ul style="list-style-type: none"> <li>• MAIN   Frequency   FREQUENCY</li> </ul>
<b>Power Key</b>	<p>Pressing <b>Power</b> displays the POWER menu in the user interface display.</p> <ul style="list-style-type: none"> <li>• MAIN   Power   POWER</li> </ul>
<b>Sweep Key</b>	<p>Pressing <b>Sweep</b> displays the SWEEP menu in the user interface display.</p> <ul style="list-style-type: none"> <li>• MAIN   Sweep Setup   SWEEP SETUP</li> </ul>
<b>Average Key</b>	<p>Pressing <b>Avg</b> displays the AVERAGING menu in the user interface display.</p> <ul style="list-style-type: none"> <li>• MAIN   Averaging   AVERAGING</li> </ul>



**Table 3-1.** Front Panel Hard Keys and Functions (7 of 8)

Key Name	Primary Functions
----------	-------------------

**Response, Display, Scale, and Marker Key Group**



<b>Response Key</b>	Pressing <b>Response</b> displays the Response menu in the user interface display. The RESPONSE menu displayed depends on whether the instrument is in 2-Port or 4-Port mode. <ul style="list-style-type: none"> <li>• MAIN   Response   RESPONSE</li> </ul>
<b>Display Key</b>	Pressing <b>Display</b> displays the Display menu in the user interface display. <ul style="list-style-type: none"> <li>• MAIN   Display   DISPLAY</li> </ul>
<b>Scale Key</b>	Pressing <b>Scale</b> displays the Scale menu in the user interface display. <ul style="list-style-type: none"> <li>• MAIN   Scale   SCALE menu</li> </ul>
<b>Marker Key</b>	Pressing <b>Marker</b> displays the Marker menu in the user interface display. <ul style="list-style-type: none"> <li>• MAIN   Marker   MARKERS [1]</li> </ul>

**Channel and Trace Key Group**



<b>Channel Key</b>	Pressing <b>Channel</b> displays the Channel menu in the user interface display. <ul style="list-style-type: none"> <li>• MAIN   Channel   CHANNEL</li> </ul>
<b>Trace Key</b>	Pressing <b>Trace</b> displays the Trace menu in the user interface display. <ul style="list-style-type: none"> <li>• MAIN   Trace   TRACE</li> </ul>

Table 3-1. Front Panel Hard Keys and Functions (7 of 8)

Key Name	Primary Functions
----------	-------------------

### Navigation and Data Entry Keys

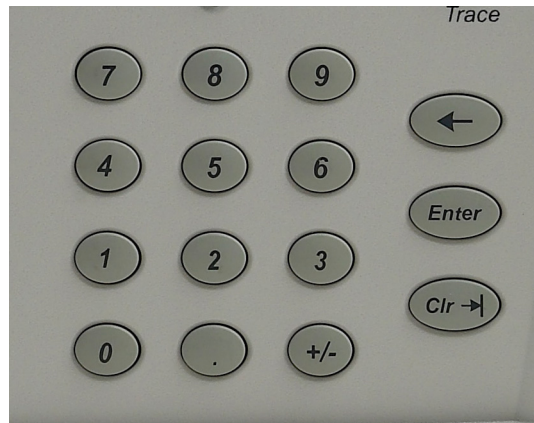


<b>Rotary Knob</b>	<p>The operation of the Rotary Knob varies depending on the cursor focus.</p> <p>On selections, rotating the <b>Rotary Knob</b> clockwise moves the selection down. Rotating counterclockwise moves the selection up.</p> <p>On menus, moves the button focus up or down.</p> <p>On field toolbars, increases or decreases the field value.</p> <p>Pressing the <b>Rotary Knob</b> starts the action of the selected menu button or applies the input value of the selected field toolbar.</p>
<b>Up Arrow Key</b>	Pressing <b>Up</b> moves the cursor or selection up.
<b>Down Arrow Key</b>	Pressing <b>Down</b> moves the cursor or selection down.
<b>Left Arrow Key</b>	Pressing <b>Left</b> moves the cursor or selection to the left.
<b>Right Arrow Key</b>	Pressing <b>Right</b> moves the cursor or selection to the right.
<b>Select Key</b>	<p>Pressing <b>Select</b> starts the action of the selected menu button.</p> <p>Same as pressing the <b>Rotary Knob</b>.</p>

**Table 3-1.** Front Panel Hard Keys and Functions (7 of 8)

Key Name	Primary Functions
----------	-------------------

**Keypad and Data Entry Key Group**



<b>Keypad Digit Keys</b>	Used to enter digits from <b>0 (zero)</b> to <b>9 (nine)</b> .
<b>. (Decimal) Key</b>	Used to enter a decimal point.
<b>+/- (Plus/Minus) Key</b>	Toggles an entered value between <b>+</b> ( <b>plus</b> ) and <b>-</b> ( <b>minus</b> ).
<b>Backspace / Delete Key</b>	Deletes characters and moves the cursor to the left.
<b>Enter Key</b>	Causes the user-defined value or the field toolbar value to be entered into the instrument.
<b>Clear/Tab Key</b>	Clears the value of a field or tabs forward to the next field.

Table 3-1. Front Panel Hard Keys and Functions (7 of 8)

Key Name	Primary Functions
<b>Test Port 1 and Loop Connectors</b>	
<b>Test Port 1</b>	Universal Test Port Connector <ul style="list-style-type: none"> <li>• K (m) for MS4642B and MS4644B</li> <li>• V (m) for MS4645B and MS4647B</li> <li>• Damage Input Levels: +27 dBm max, 40 VDC max</li> <li>• Exchangeable in case of damage.</li> </ul>
<b>Port 1 Source</b>	Source paths, $\geq 2.5$ GHz coverage. <ul style="list-style-type: none"> <li>• K (f) for MS4642B and MS4644B.</li> <li>• V (f) for MS4645B and MS4647B.</li> <li>• Damage Input Levels: +20 dBm max, 0 VDC max</li> <li>• Optional. Included with Option 51 and 6x. This port is also used to interface with MN469xx Series 4-Port Test Sets and ME7838x Series 4-Port Broadband/Millimeter Wave Systems.</li> </ul>
<b>b<sub>1</sub> Test Receiver - Port 1</b>	Test receiver paths. <ul style="list-style-type: none"> <li>• As above.</li> <li>• Optional. Included with Option 51 and 6x.</li> </ul>
<b>a<sub>1</sub> Reference Receiver - Port 1</b>	Reference receiver paths. <ul style="list-style-type: none"> <li>• As above.</li> <li>• Optional. Included with Option 51 and 6x.</li> </ul>

Table 3-1. Front Panel Hard Keys and Functions (7 of 8)

Key Name	Primary Functions
----------	-------------------

**Test Port 2 and Loop Connectors**



<b>Test Port 2</b>	Universal Test Port Connector. <ul style="list-style-type: none"> <li>• K (m) for MS4642B and MS4644B</li> <li>• V (m) for MS4645B and MS4647B</li> <li>• Damage Input Levels: +27 dBm max, 40 VDC max</li> <li>• Exchangeable in case of damage.</li> </ul>
<b>Port 2 Source</b>	Source paths, $\geq 2.5$ GHz coverage. <ul style="list-style-type: none"> <li>• K (f) connectors for the MS4642B and MS4644B VNAs.</li> <li>• V (f) connectors for the MS4645B and MS4647B VNAs.</li> <li>• Damage Input Levels: +20 dBm max, 0 VDC max</li> <li>• Optional. Included with Option 51 and 6x. This port is also used to interface with MN469xx Series 4-Port Test Sets and ME7838x 4-Port Series Broadband/Millimeter Wave Systems.</li> </ul>
<b>b<sub>2</sub> Test Receiver - Port 2</b>	Test receiver paths. <ul style="list-style-type: none"> <li>• As above.</li> <li>• Optional. Included with Option 51 and 6x.</li> </ul>
<b>a<sub>2</sub> Reference Receiver - Port 2</b>	Reference receiver paths. <ul style="list-style-type: none"> <li>• As above.</li> <li>• Optional. Included with Option 51 and 6x.</li> </ul>

**Front Panel USB Ports**



<b>USB Ports</b>	USB 2.0 Type A Ports, two (2) each. <ul style="list-style-type: none"> <li>• For peripherals such as keyboard, mouse, memory stick, or hardware key.</li> <li>• There are two additional USB 2.0 Type A Ports located on the rear panel.</li> </ul>
------------------	---



### 3-4 Rear Panel Ports and Connectors

The MS464xB Series VNA rear panel connectors are shown below in [Figure 3-2, “MS464xB Series VNA Rear Panel Ports and Connectors”](#) on page 3-12 which provides identification of each connector and port.

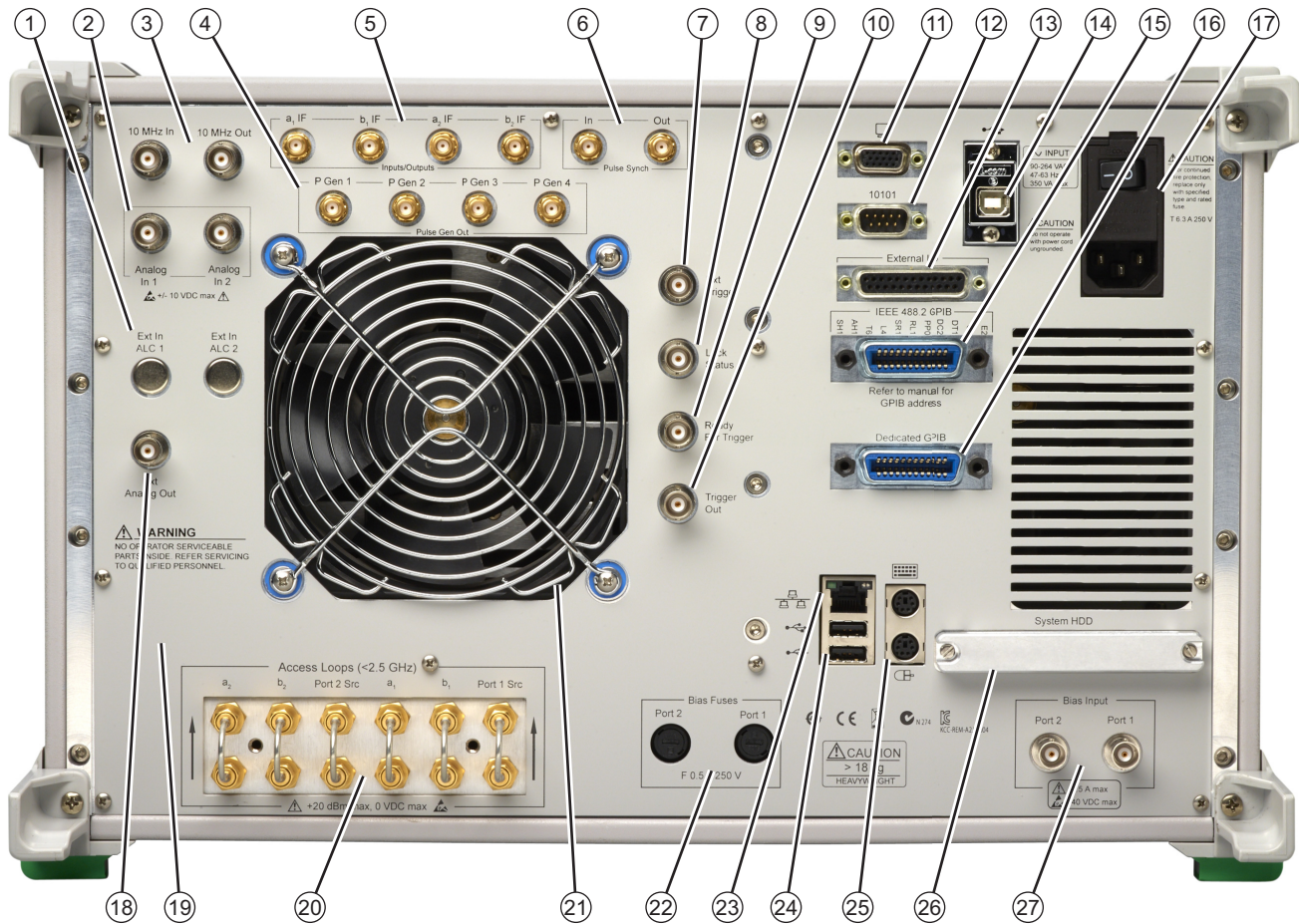


Figure 3-2. MS464xB Series VNA Rear Panel Ports and Connectors (1 of 2)

<p>All ports and controls are standard and equipped on all models unless otherwise noted.</p> <ol style="list-style-type: none"> <li>1. Ext. ALC 1 and ALC 2 BNC (f) – External Automatic Leveling Control, one for each installed source Ext ALC 1 is available with any of Options 53, 80/81/82/83, 86/87. Ext ALC 1 and Ext ALC 2 are both available with Option 31 and any of Options 53, 84/85, 88/89.</li> <li>2. Analog Inputs: Analog In 1 (on left) and Analog In 2 (on right).</li> <li>3. 10 MHz Reference: 10 MHz In BNC (f) (on left) and 10 MHz Out BNC (f) (on right).</li> <li>4. Pulse Generator Output (4 generator outputs).</li> <li>5. IF Input/Outputs: a1 IF Input/Output (on left), b1 IF Input/Output (on left center), a2 IF Input/Output (on right center), and b21 IF Input/Output (on right).</li> <li>6. Pulse Synch In (on left) and Pulse Synch Out (on right).</li> <li>7. Ext. Trigger BNC (f) – External Trigger.</li> <li>8. Lock Status BNC (f).</li> <li>9. Ready for Trigger BNC (f).</li> <li>10. Trigger Out BNC (f).</li> <li>11. XGA/VGA 15-pin D-Sub Connector (f).</li> <li>12. Serial (10101) 9-pin D-Sub Connector (f): A standard RS-232C serial port for computer peripherals. Also for instrument control of special purpose peripherals such as AutoCal calibrator modules.</li> <li>13. External I/O 25-pin D-Sub Connector (f).</li> <li>14. USB 2.0 Type B Port: USB connection when instrument is controlled by a USB controller.</li> <li>15. IEEE 488.2 GPIB (f) Port: GPIB port for GPIB talker/listener.</li> <li>16. Dedicated GPIB (f) Port: GPIB port for control of peripheral devices such as a Power Meter or External Source.</li> </ol>	<ol style="list-style-type: none"> <li>17. AC Input Module Connector: Contains the AC Power Rocker Switch, the AC Power Internal Fuses (located under the switch), and the IEC C14 Chassis AC Power Socket.</li> <li>18. Ext. Analog Out BNC (f) – External Analog Out.</li> <li>19. Anritsu Company Instrument Serial Number and Installed Options Sticker, and Microsoft Windows Software License Sticker.</li> <li>20. Access Loops: Optional. <ul style="list-style-type: none"> <li>• Only equipped with MS464xB VNAs with Option 51 or 6x.</li> <li>• If equipped, the &lt; 2.5 GHz Access Loops are (from left to right): a2 Access Loop, b2 Access Loop, Port 2 Src Access Loop, a1 Access Loop, b1 Access Loop, and Port 1 Src Access Loop.</li> </ul> </li> <li>21. Ventilation Fan and Grill.</li> <li>22. Bias Fuses: Bias Fuse Port 2 (on left) and Bias Fuse Port 1 (on right).</li> <li>23. 10/100BaseT Ethernet Port: RJ-45 LAN port.</li> <li>24. USB 2.0 Type A Ports: USB connection ports for computer peripheral devices such as a printer, keyboard, or mouse. Note that there two (2) additional USB 2.0 Type A Ports on the front panel.</li> <li>25. Keyboard PS/2 Mini-DIN Port and Mouse PS/2 Mini-DIN Port.</li> <li>26. System HDD: The internal Solid State Drive (or Hard Disk Drive on older units).</li> <li>27. Bias Input Ports: Bias Input Port 2 (on left) and Bias Input Port 1 (on right).</li> </ol>
--	--

**Figure 3-2.** MS464xB Series VNA Rear Panel Ports and Connectors (2 of 2)

## Rear Panel Port and Connector Descriptions

A summary of the VectorStar VNA rear panel connectors is available in [Table 3-2](#) below. The table defines each connectors name, its connector type and general specifications. The External I/O Connector also provides a connector pin-out diagram.

**Table 3-2.** VectorStar MS464xB Series VNA Rear Panel Connectors (1 of 13)

Connector Name	Primary Function / Cross References
----------------	-------------------------------------

### AC Power Connectors and Controls



<b>AC Power Input Module</b>	Contains the <b>AC Power Rocker Switch</b> , the <b>AC Power Internal Fuses</b> (under the switch) and the <b>IEC C14 Chassis AC Power Socket</b> , described in rows below.
<b>AC Power Rocker Switch</b>	<p><b>Power On</b></p> <p>Used to the turn the VNA on and off where “I” is ON and “O” is OFF.</p> <p><b>Standby to Operate Mode</b></p> <p>Once turned on, the VNA is in standby mode. On the front panel, press and hold the left side <b>Standby/Operate</b> key for at least one (1) second to place the VNA in operate mode.</p> <p><b>Operate to Standby Mode</b></p> <p>With the VNA in operate mode, press and hold the <b>Standby/Operate</b> key for at least one second to return the VNA to standby mode.</p> <p><b>Power Off</b></p> <p><b>Only turn off the VNA when it is in standby mode. Do not disconnect the AC power while the VNA is in operate mode. Do not turn off the VNA while it is in operate mode.</b></p>



**Table 3-2.** VectorStar MS464xB Series VNA Rear Panel Connectors (2 of 13)

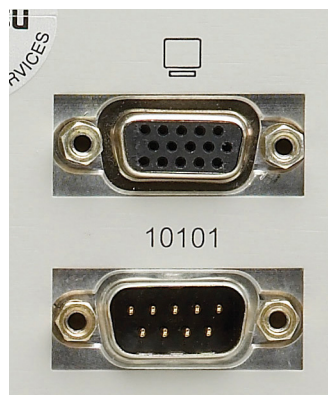
Connector Name	Primary Function / Cross References
<b>AC Power Internal Fuses</b>	Use the tab in the <b>AC Power Rocker Switch</b> (described above) to remove the fuse cover and access the fuses.  Two (2) T-Type 6.3 A 250 Volt internal fuses  Rated for 700 VA max  90-264 VAC, 47-63 Hz (power factor controlled)
<b>IEC C14 Chassis AC Power Socket</b>	Allows for a cable connection to AC mains power using the IEC C13 AC Line Socket on the provided power cord. The other end of the provided power cord provides a plug suitable for the instrument location.

**USB Control Port**



<b>USB Control Port</b>	USB 2.0 Type B Port  controlling the instrument externally and for remote operation.
-------------------------	--

**XGA/VGA and Serial (10101) Ports**



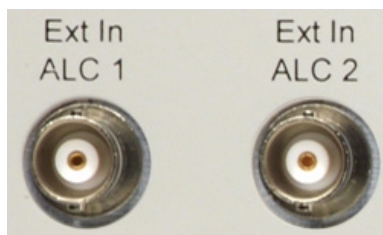
<b>XGA/VGA Video Port</b>	15-pin Mini D-Sub (f) Connector  For simultaneously projecting the instrument's screen display onto an external VGA monitor, with minimum resolution of 1024 x 768.
---------------------------	---

**Table 3-2.** VectorStar MS464xB Series VNA Rear Panel Connectors (3 of 13)

Connector Name	Primary Function / Cross References
<b>Serial (10101) Port</b>	9-pin Mini D-Sub (f) Connector Compatible with RS-232C. Provides control for AutoCal modules and other accessories.

**External Analog Out Ports**

<b>External (Ext) Analog Out</b>	BNC (f) Connector External Analog Output. For external attenuator control, external switch control, analog triggering assistance, measurement system integration and other purposes. Normal operating modes: Sawtooth sync sweep, TTL indication of driving port, open loop level controller. Range: -10 V to +10 V; low impedance drive. Accuracy: 20 mV + 2%.
----------------------------------	---

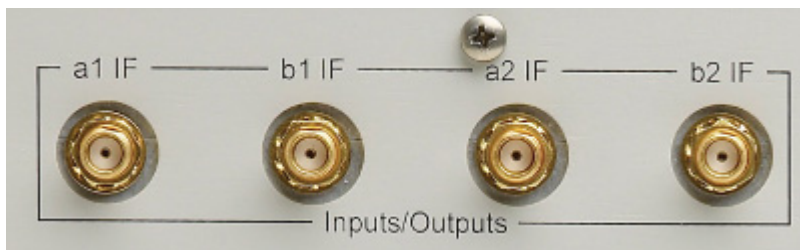
**External In ALC Ports**

<b>External (Ext) Automatic Level Control (ALC)</b>	Ext ALC 1 is available with any of Options 53, 80/81/82/83, 86/87. Ext ALC 1 and Ext ALC 2 are both available with Option 31 and any of Options 53, 84/85, 88/89. BNC (f) Connector External Automatic Level Control for both internal signal source generators.
---	---

**Table 3-2.** VectorStar MS464xB Series VNA Rear Panel Connectors (4 of 13)

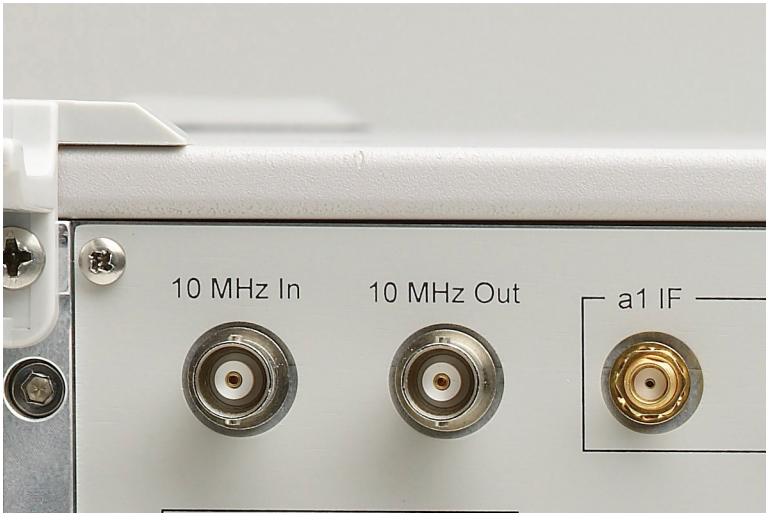
Connector Name	Primary Function / Cross References
----------------	-------------------------------------

**IF Input/Output Loop Connectors**



<b>Input/Outputs a1 IF</b>	<p>SMA (f) Connectors</p> <p>Inputs used with external converters such as mmWave (mm-W) modules, or for antenna testing.</p> <p>Outputs used with external IF digitizers and processors.</p> <p>Nominal Inputs: 5 to 20 MHz (mode dependent), 0 dBm for full scale Nominal.</p> <p>Outputs: 0.2 to 100 MHz (mode dependent), +10 dBm max</p> <p>These ports also used to interface with the VectorStar ME7838x Broadband/Millimeter Wave Systems.</p>
<b>Input/Outputs b1 IF</b>	<p>SMA (f) Connectors</p> <p>As above.</p>
<b>Input/Outputs a2 IF</b>	<p>SMA (f) Connectors</p> <p>As above.</p>
<b>Input/Outputs b2 IF</b>	<p>SMA (f) Connectors</p> <p>As above.</p>

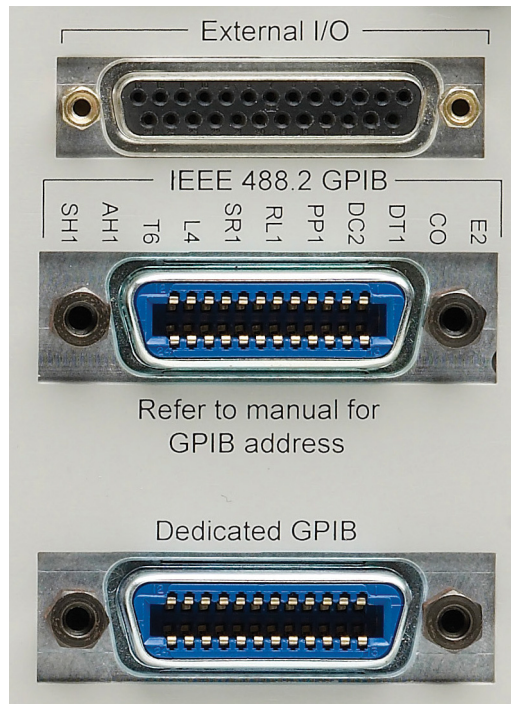
**Table 3-2.** VectorStar MS464xB Series VNA Rear Panel Connectors (5 of 13)

Connector Name	Primary Function / Cross References
<b>10 MHz Input/Output Ports</b>	
	
<b>10 MHz Input</b>	BNC (f) Connector Auto-sensing, better than 0.001 Hz/Hz accuracy recommended. Signal: -10 dBm to +3 dBm, Nominal 50 Ohms.
<b>10 MHz Output</b>	BNC (f) Connector Derived from the internal reference time base, unless an external 10 MHz reference input is applied. 0 ± 5 dBm sinusoidal, 50 Ohms

**Table 3-2.** VectorStar MS464xB Series VNA Rear Panel Connectors (6 of 13)

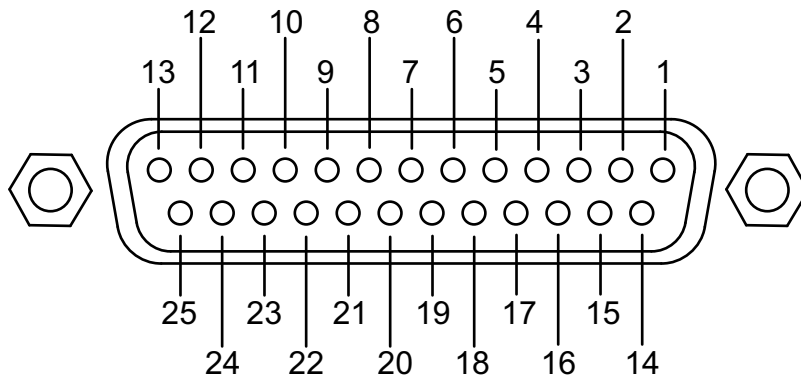
Connector Name	Primary Function / Cross References
----------------	-------------------------------------

**External I/O and GPIB Ports**



<p><b>External I/O Port</b></p>	<p>25-pin D-Sub (f) connector.</p> <p>User-defined I/O for custom external test set interface, to synchronize with different sweep states, such as Start, Stop, or Driven Port. The next section provides a pin out diagram of the connector.</p>
---------------------------------	---

**External I/O Port Connector Pin Out**



<p>Pin Number 1</p>	<p>Limit Pass/Fail – Indicates the results of limit testing for all channels. User selectable from the Limit Line setup menu. (0 V to 3.3 V) TTL-high = Fail or TTL-low = Fail.</p>
---------------------	---

**Table 3-2.** VectorStar MS464xB Series VNA Rear Panel Connectors (7 of 13)

Connector Name	Primary Function / Cross References
Pin Numbers 2, 3, 15, 16	TTL In – Configurable as a digital input for use in sending information to the instrument from external sensors or input devices. The inputs are TTL compatible and 5 V tolerant.
Pin Numbers 4, 13, 14, 21	GND – Digital signaling ground.
Pin Numbers 5 - 12, 17-20, 22	TTL Out – Configurable as a digital output for use in sending information to external devices, handlers, and output processors. The outputs are 0 V low and +3.3 V high and are TTL compatible.
Pin Numbers 23 - 25	Reserved – Reserved for controlling Anritsu external test sets.
Notes	Pins 17-25 are not available when using a 3739 test set.
<b>IEEE 488.2 GPIB Port</b>	24-Pin (f) GPIB Connector GPIB talker/listener port IEEE 488.2 compatible, for controlling the instrument externally, for remote operation.
<b>Dedicated GPIB Port</b>	24-Pin (f) GPIB Connector. Dedicated GPIB controller port For the control of external instruments such as power meters, external test sets, or other GPIB compatible accessories.

### External Trigger and Lock Ports



**Table 3-2.** VectorStar MS464xB Series VNA Rear Panel Connectors (8 of 13)

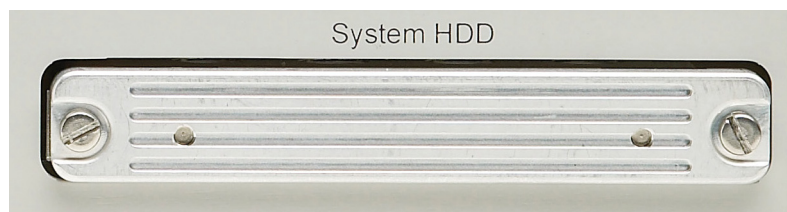
Connector Name	Primary Function / Cross References
Ext Trigger	BNC (f) Connector External Trigger
Lock Status	BNC (f) Connector Trigger Lock Status
Ready for Trigger	BNC (f) Connector
Trigger Out	BNC (f) Connector

**Analog In Ports**



<b>Analog Input 1</b>	<p>BNC (f) Connector</p> <p>Independent input for measurements simultaneous with the RF measurements, for current sensing, efficiency computation, and power detection.</p> <p>Range: -10 V to +10 V with automatic offset and gain calibrations.</p> <p>Accuracy: 2 mV + 2% for <math> V  &lt; 5 \text{ V}</math>; 2% for <math> V  &gt; 5 \text{ V}</math></p> <p>Nominal input impedance: 60 K Ohms.</p>
<b>Analog Input 2</b>	<p>BNC (f) Connector</p> <p>As above.</p>

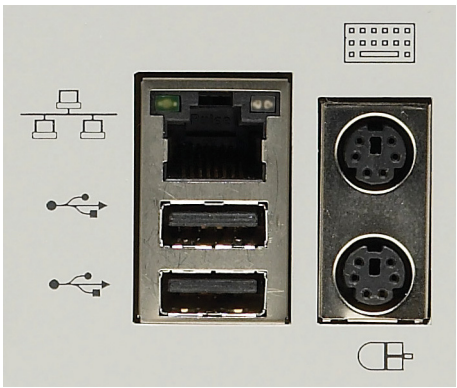
**Internal System Drive (System HDD)**



<b>System SSD/HDD</b>	<p>The system removable Solid State Drive (or Hard Disk Drive on older VNAs). If spare drives are available, the SSD/HDD can be quickly exchanged for security or other reasons.</p>
-----------------------	--



**Table 3-2.** VectorStar MS464xB Series VNA Rear Panel Connectors (9 of 13)

Connector Name	Primary Function / Cross References
<b>Network, USB, and PS2 Connectors</b>	
	
<b>LAN Ethernet Port</b>	10/100BaseT Ethernet RJ-45 Connector. Standard.
<b>Universal Series Bus (USB) 2.0 Type A Ports</b>	USB 2.0 Type A Ports, two (2) on Rear Panel. For peripherals such as keyboard, mouse, memory stick, and hardware key. There are two additional USB 2.0 Type A Ports located on the front panel.
<b>Keyboard/Mouse PS/2 Ports</b>	Dedicated Mini-DIN PS/2 ports, two (2) on Rear Panel. Used to connect a PS/2 keyboard and/or a PS/2 mouse. With a user-supplied <b>PS/2 to USB</b> adapter, can be used to connect a USB keyboard and USB mouse, sparing the USB 2.0 ports for additional peripherals.

**Bias Input Ports**

<b>Bias Input Port 1 Connector</b>	BNC (f) Connector. One input per Bias Input Port Optional. Equipped with Option 51 or 6x.
<b>Bias Input Port 2 Connector</b>	BNC (f) Connector. As above.

**Table 3-2.** VectorStar MS464xB Series VNA Rear Panel Connectors (10 of 13)

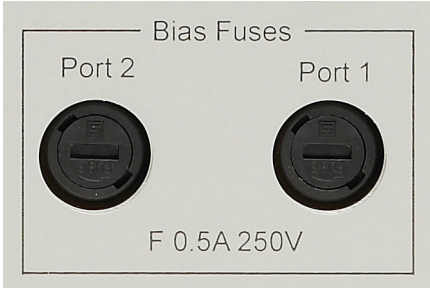

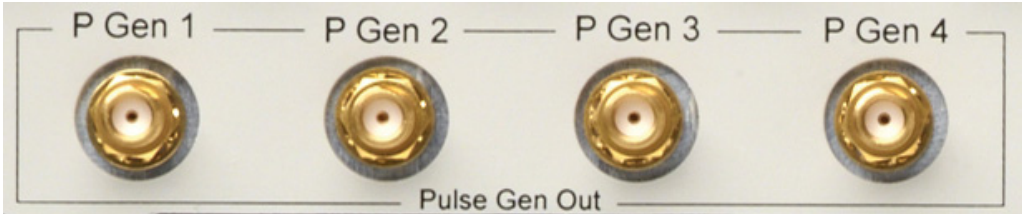
Connector Name	Primary Function / Cross References
<b>Bias Fuses</b>	
	
<b>Bias Fuse Port 1</b>	Fuse Connector Included with optional Bias Input Ports above. One fuse per Bias Input Port Fuses are F-Type rated at 0.5 A, 250 V.
<b>Bias Fuse Port 2</b>	Fuse Connector As above.

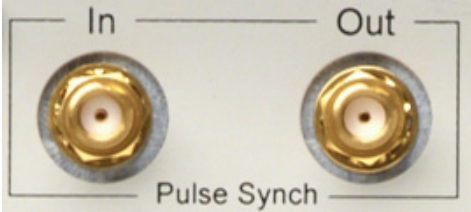
Table 3-2. VectorStar MS464xB Series VNA Rear Panel Connectors (11 of 13)

Connector Name	Primary Function / Cross References
<p><b>Access Loops (&lt; 2.5 GHz)</b></p> 	
<b>a2 Access Loop</b>	<p>SMA (f) port with SMA (m) loop. Optional. Included with Options 51 or 6x. Receiver path for Port 2 For &lt;2.5 GHz frequency coverage. Damage Input Level: +20 dBm max, 0 VDC max</p>
<b>b2 Access Loop</b>	<p>SMA (f) port with SMA (m) loop. Optional. Included with Options 51 or 6x. Test receiver path for Port 2. Specifications as above. Also used to connect with the VectorStar MN469xx 4-Port (Multi-Port) Test Sets.</p>
<b>Port 2 Src Loop</b>	<p>SMA (f) port with SMA (m) loop. Optional. Included with Options 51 or 6x. Port 2 Source path. Specifications as above. Also used to connect with the VectorStar MN469xx 4-Port (Multi-Port) Test Sets.</p>
<b>a1 Access Loop</b>	<p>SMA (f) port with SMA (m) loop. Optional. Included with Options 51 or 6x. Receiver path for Port 1. Specifications as above.</p>
<b>b1 Access Loop</b>	<p>SMA (f) port with SMA (m) loop. Optional. Included with Options 51 or 6x. Test receiver path for Port 1. Specifications as above. Also used to connect with the VectorStar MN469xx 4-Port (Multi-Port) Test Sets.</p>
<b>Port 1 Src Loop</b>	<p>SMA (f) port with SMA (m) loop. Optional. Included with Options 51 or 6x. Port 1 Source path. Specifications as above. Also used to connect with the VectorStar MN469xx 4-Port (Multi-Port) Test Sets.</p>

**Table 3-2.** VectorStar MS464xB Series VNA Rear Panel Connectors (12 of 13)

Connector Name	Primary Function / Cross References
<b>Pulse Generator Outputs</b>	
	
<p><b>P Gen 1</b></p> <p><b>P Gen 2</b></p> <p><b>P Gen 3</b></p> <p><b>P Gen 4</b></p>	<p>All Pulse Generators, nominal:</p> <p>SMA (f) connectors</p> <p>High: 3.3 V +/- 10%</p> <p>Low: &lt; 1 V</p> <p>Drive Impedance: Low impedance (approximately 50 Ω)</p> <p>Load Impedance: 50 Ω or higher impedance</p> <p>Notes:</p> <ul style="list-style-type: none"> <li>• Polarity inversion can be set via the PulseView™ configuration dialog. Pulse generator outputs are always active, even when the pulse generators are disabled.</li> <li>• Series load resistance should be kept lower than 10 Ω for typical logic families.</li> </ul>

**Table 3-2.** VectorStar MS464xB Series VNA Rear Panel Connectors (13 of 13)

Connector Name	Primary Function / Cross References
<b>Pulse Synch Inputs and Outputs</b>	
	
<b>Pulse Synch In</b>	SMA (f) connector Nominal values: High: 3.3 V +/- 10% Low: < 1 V 5.5 VDC damage level 55 ns delay from received synch to $T_0$ (typical) High impedance input
<b>Pulse Synch Out</b>	SMA (f) connector Nominal values: High: 3.3 V +/- 10% Low: < 1 V < 5 ns delay from $T_0$ to providing an external synch (typical) Drive Impedance: Low impedance (approximately 50 $\Omega$ ) Load Impedance: 50 $\Omega$ or higher impedance Notes: <ul style="list-style-type: none"> <li>• Pulse Synch Out is always active, even when the pulse generators are disabled.</li> <li>• Series load resistance should be kept lower than 10 <math>\Omega</math> for typical logic families.</li> </ul>

# Chapter 4 — User Interface Display

## 4-1 Chapter Overview

The chapter describes the general display options of the VectorStar MS464xB Series VNA and provides a general description of the MENU BAR, the ICON TOOLBAR, and the right-side function menus. General descriptions and procedures are provided for channel setup, trace graph setup, marker setup, and limit line setup. The VectorStar MS464xB Series VNA displays measurement data using a “Channel Concept” where each channel can display both a different S-Parameter (or another specialty parameter) and a different graph type. As each channel is selected, the previously selected trace graph types, scaling, reference delay, S-Parameter, and other parameters associated with that channel appear on the screen. In addition, the same S-Parameter can be displayed simultaneously on two or more channels using the same or different trace graph types.

## 4-2 User Interface Main Screen

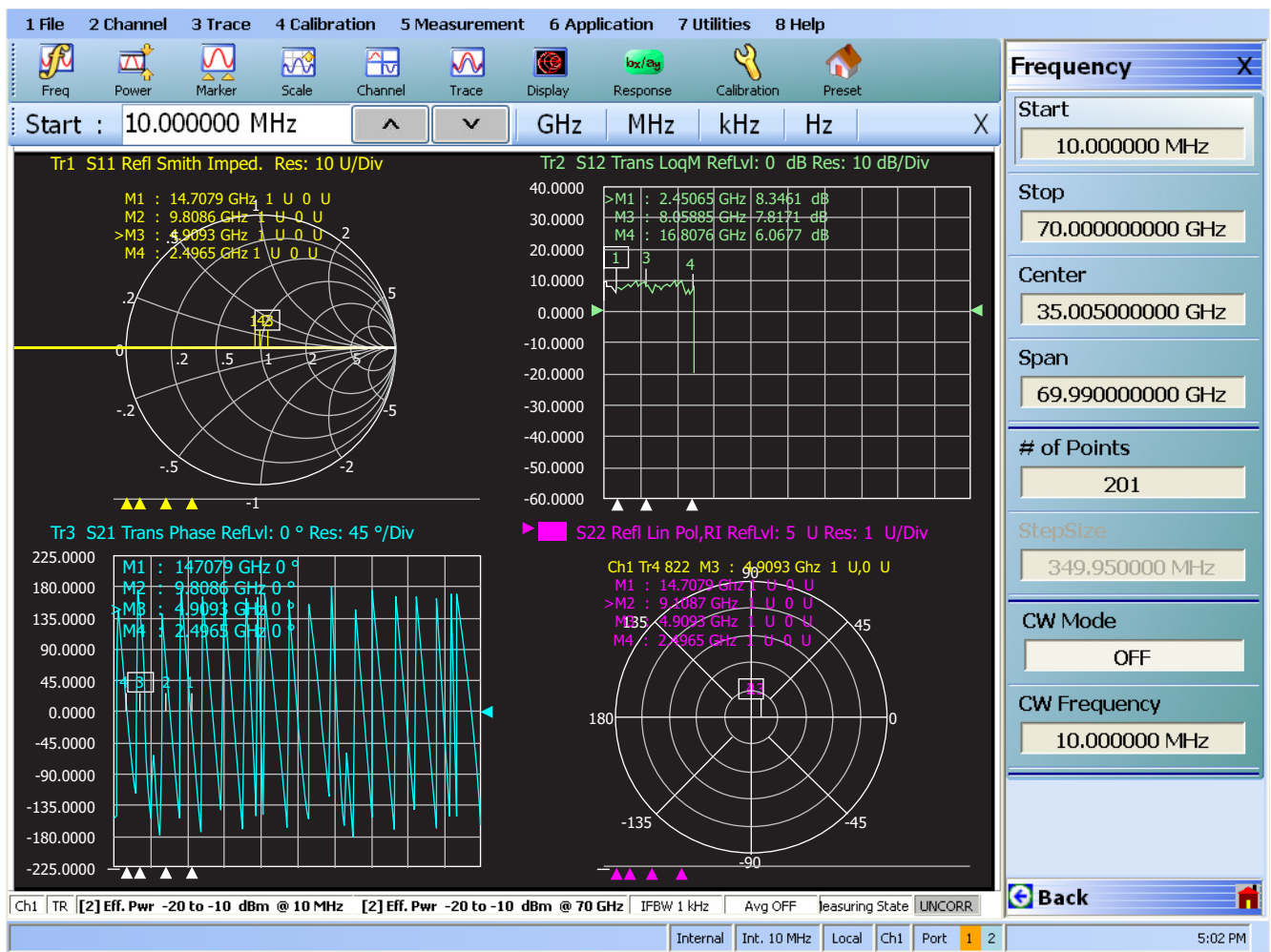


Figure 4-1. User Interface - Single Channel - Four Traces - Frequency Menu



## User Interface Control and Display Areas

The entire instrument main display is a touch screen that can be manipulated by touching, or by clicking with an attached USB mouse. The figure below shows the general display areas for a single channel displaying four graphical traces.

### Note

When using the touch screen, a recommended best practice is to use a positive hard press to make sure the required setting is input into the system. A light touch may not change the instrument setting as required.

To recalibrate the touch screen, navigate to the CALIBRATE TOUCH SCREEN dialog box located at **MAIN | System | SYSTEM | Utility | UTILITY | Calibrate Touch Screen | TOUCH SCREEN CONTROL PANEL** dialog box. The procedure is described in the **User Interface Reference Manual**.

A detailed touch screen calibration and adjustment procedure is described in the **VectorStar MS464xB Series VNA Maintenance Manual**.

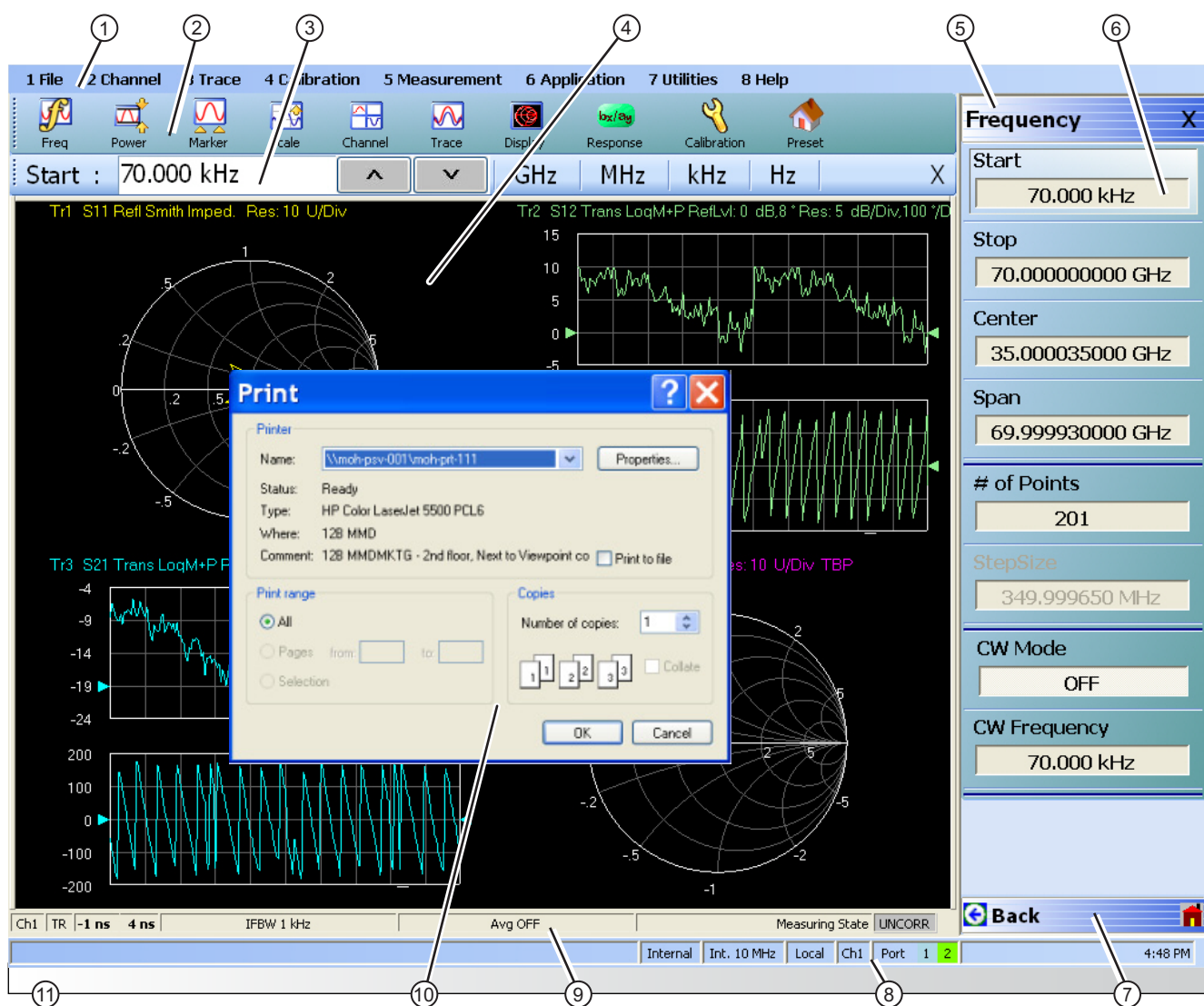


Figure 4-2. User Interface Display Areas (1 of 2)



<ol style="list-style-type: none"> <li>1. Menu Bar – Displays eight (8) drop-down menus: File, Channel, Trace, Calibration, Measurement, Application, Utilities, and Help.</li> <li>2. Icon Toolbar – User-configured with up to 10 user-selected quick access icons.</li> <li>3. Field Toolbar – Appears only when field button is clicked for input. Display field for value, with one or more units (such as dB, dBm, or Hz), an Enter button, and an X close button.</li> <li>4. Display Area – Displays from one to 16 channels. Each channel can have from one to 16 trace display graphs. Each trace display can optionally have from one to 12 markers, a reference marker, and an upper and lower limit line.</li> <li>5. Menu Title – Displays the name of the displayed right-side menu. Menu titles are unique to each menu.</li> <li>6. Menu Buttons – The menu buttons allow the user to set parameters, make configuration selections, read result values, start processes, toggle between two or more values, display sub-menus, and display dialog boxes.</li> </ol>	<ol style="list-style-type: none"> <li>7. Menu Navigation Buttons – The navigation buttons always appear at the bottom of the right-side menu and allow browser-like forward and backward navigation through the user's history. Back returns to previous selected higher-level menu, Next returns to a previously selected lower-level menu), and Home returns to the Main Menu.</li> <li>8. System Status Bar – Displays status messages, and configuration status that affects the entire instrument.</li> <li>9. Channel Status Bar – Provides status for each channel display near the bottom of the screen. If multiple channels are displayed, there is a separate status bar for each channel display.</li> <li>10. Dialog Box Display Area – Most dialog boxes, whether from the VNA or from the underlying operating system, appear in the center of the display area.</li> <li>11. Tableau Data Display/Input Area – The tableau area only appears when the appropriate menu button is selected. When selected, the display shrinks upwards and the tabular data area expands.</li> </ol>
---	--

**Figure 4-2.** User Interface Display Areas (2 of 2)

For all VectorStar VNA models, if the instrument is in 25,000 point mode, multiple channels can be selected by the user. For the VectorStar MS464xB Series VNA, in 100,000 point mode, the instrument is limited to one channel. Each available channel can have up to 16 graphical traces. The figure below shows an instrument setup with four channels, each with four traces. The channel and trace display layout shown below is user-defined as a  $2 \times 2$  configuration for channels and traces.

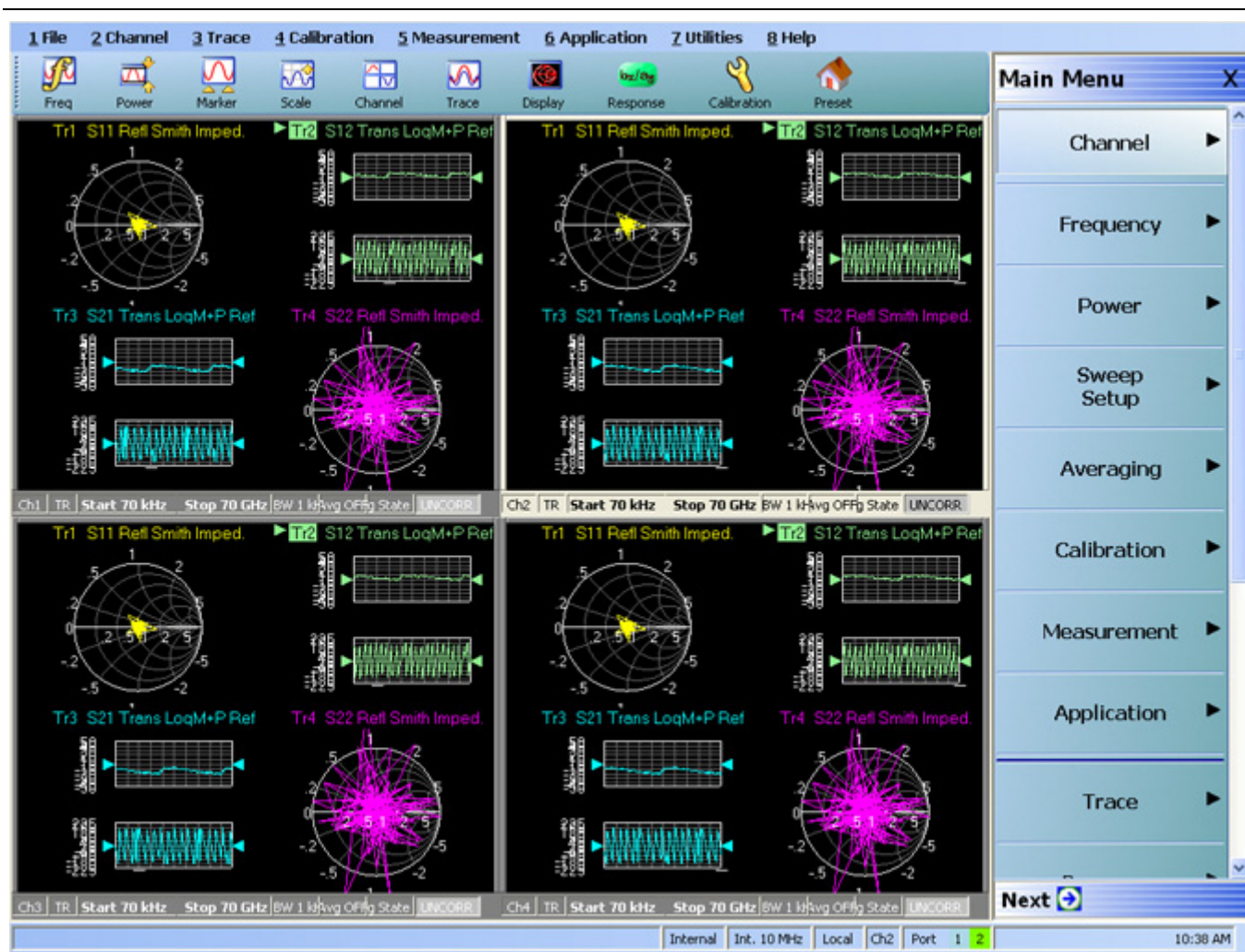


Figure 4-3. Four Channels – Each channel with Four Traces –16 Total Traces

## Function Access

The VectorStar MS464xB Series VNA provides multiple methods to access the menus and functions that include:

- Front panel keys
- Attached USB mouse
- Attached USB keyboard
- Display touch screen

Each of the methods above can manipulate the instrument through the five major user interface areas on the main display:

- The top MENU BAR with its drop-down menus and menu commands.
- The ICON TOOLBAR with up to 10 single-click functions, available as a default configuration or as a user-definable configuration of icon functions.
- The right side APPLICATION MENU system that provides access to over 100 function menus, sub-menus, dialog boxes, and configuration options.
- For some parameters, selecting a button displays a FIELD TOOLBAR that appears just below the icon toolbar allowing input of parameter values and units.
- For some parameters, selecting a button displays a CONFIGURATION or SETUP TABLEAU below the main display area for input of complex parameter sets such as segmented frequency or power sweeps.

### To Select a Channel

1. To select a channel in a multi-channel display, do one of the following:
  - Click anywhere inside the desired channel box.
  - From the keyboard, **ALT + 2** then **7** to view the previous channel or **ALT + 2** then **8** to view the next channel.
  - On the top menu bar, select MENU BAR | Channel | Channel Prev or MENU BAR | Channel | Channel Next.
  - On the right side menu, select MAIN | Channel | CHANNEL | Chan Next or Chan Previous.
2. The selected channel border changes from gray to white. [Figure 4-3 on page 4-4](#) shows Channel 2 (Ch2) selected.

**Note**

The **Ch->Max**, **Ch->Next**, and **Ch->Prev** icons are available for the icon toolbar. These icons provide one click access to channel maximum, channel next, and channel previous functions. They can be added to the icon toolbar for a custom configuration and saved as part of a preset configuration.

### To Maximize a Channel Display

1. Use one of the methods above to select the desired channel.
2. Do one of the following to maximize the selected channel:
  - From the keyboard, enter **CTRL + 1** or **ALT + 2**, then **6**.
  - On the main display, double-click on the channel border box.
  - On the top menu bar, select MENU BAR | Channel | Channel Max
  - On the right side menu, select MAIN | Channel | CHANNEL | Chan. Max
3. The selected channel now fills the display area.
  - Maximize a channel display to review the channel status information at the bottom of its screen.

### To Make the Display Area Larger

1. The top icon toolbar and the right side menus can be removed to make the display area larger.
2. Remove the icon toolbar by doing one of the following:
  - From the keyboard, select **ALT + 7** then **2**.
  - On the top menu bar, select MENU BAR | Utilities | Toolbar Off.
3. The icon toolbar disappears. Repeat **Step #2** to make the icon toolbar re-appear.
4. Remove the right side menus by doing one of the following:
  - From the keyboard, enter **ALT + 7** then **7**.
  - On the top menu bar, select MENU BAR | Utilities | Clear.
5. The right side menu disappears. Repeat **Step #4** to make the menu re-appear.

### To Select Traces within a Channel

1. Use one of the methods above to maximize the channel display.
2. To select a trace in a multi-trace display, do one of the following:
  - With a mouse, single click the trace title.
    - If you double-click either the trace title or anywhere within the trace, the trace is both selected and maximized.
  - From the keyboard, enter **ALT + 3** then **7** to view the previous trace or **ALT + 3** then **8** to view the next trace.
  - On the top menu bar, select MENU BAR | Trace | Trace Prev or MENU BAR | Trace | Trace Next.
  - On the right side menu, select MAIN | Trace | TRACE | Trace Previous or Trace Next.
  - The selected trace number is highlighted and a left arrow appears.



**Figure 4-4.** Trace Selection Indicator

#### Note

The **Tr->Max**, **Tr->Next**, and **Tr->Previous** icons are available for the icon toolbar. These icons provide one click access to trace maximum, trace next, and trace previous functions. They can be added to the icon toolbar for a custom configuration and saved as part of a preset configuration.

### To Maximize a Trace Display

1. Use one of the methods above to select the desired trace.
2. For a maximum display, make sure the trace's channel is maximized.
3. Do one of the following to maximize the selected trace:
  - From the keyboard, select **ALT + 3**, then **6**.
  - On the main display, double-click anywhere in the trace display.
  - On the top menu bar, select MENU BAR | Trace | Trace Max.
  - On the right side menu, select MAIN | Trace | TRACE | Trace Max.
4. The selected trace now fills the display area.
  - Maximize a trace display to review the trace status information at the bottom of trace screen.
5. Repeat the actions above to return the trace to its normal size.

## 4-3 Using the Front Panel Keys

Most front panel keys go directly to a specific first-level menu or sub-menu function. See [Chapter 3, “Front and Rear Panels”](#) for a detailed description of all front panel keys and ports.

**Table 4-1.** Front Panel Hard Key Summary

Key Name	Primary Functions
<b>Power Key</b>	Pressing the <b>Power</b> key toggles the VNA between Operate mode and Standby mode. Before using this key, make sure the rear panel <b>AC Power Input Connector Switch</b> is set to <b>ON</b> .
<b>Calibration Key</b>	Pressing <b>Calibration</b> displays the user interface Calibration menu.
<b>Measurement Key</b>	Pressing <b>Measurement</b> displays the Measurement menu in the user interface display.
<b>Application Key</b>	Pressing <b>Application</b> displays the Application menu in the user interface display.
<b>System Key</b>	Pressing <b>System</b> displays the System menu in the user interface display.
<b>File Key</b>	Pressing <b>File</b> displays the File menu in the user interface display.
<b>Help Key</b>	Pressing <b>Help</b> displays the Help menu in the user interface display.
<b>Preset Key</b>	Returns the instrument to the last active configuration preset loaded.
<b>Frequency Key</b>	Pressing <b>Frequency</b> displays the Frequency menu in the user interface display.
<b>Power Key</b>	Pressing <b>Power</b> displays the Power menu in the user interface display.
<b>Sweep Key</b>	Pressing <b>Sweep</b> displays the Sweep menu in the user interface display.
<b>Average Key</b>	Pressing <b>Avg</b> displays the Averaging menu in the user interface display.
<b>Response Key</b>	Pressing <b>Response</b> displays the Response menu in the user interface display.
<b>Display Key</b>	Pressing <b>Display</b> displays the Display menu in the user interface display.
<b>Scale Key</b>	Pressing <b>Scale</b> displays the Scale menu in the user interface display.
<b>Marker Key</b>	Pressing <b>Marker</b> displays the Marker menu in the user interface display.
<b>Channel Key</b>	Pressing <b>Channel</b> displays the Channel menu in the user interface display.
<b>Trace Key</b>	Pressing <b>Trace</b> displays the Trace menu in the user interface display.

## 4-4 Using the Menu Bar Interface

### Menu Bar Overview

The menu bar at the top of the screen provides eight drop-down menus for quick access to major VectorStar VNA menu functions and dialogs. The configuration is fixed and not user-configurable. The figure below shows all of the available MENU BAR functions and command menus.

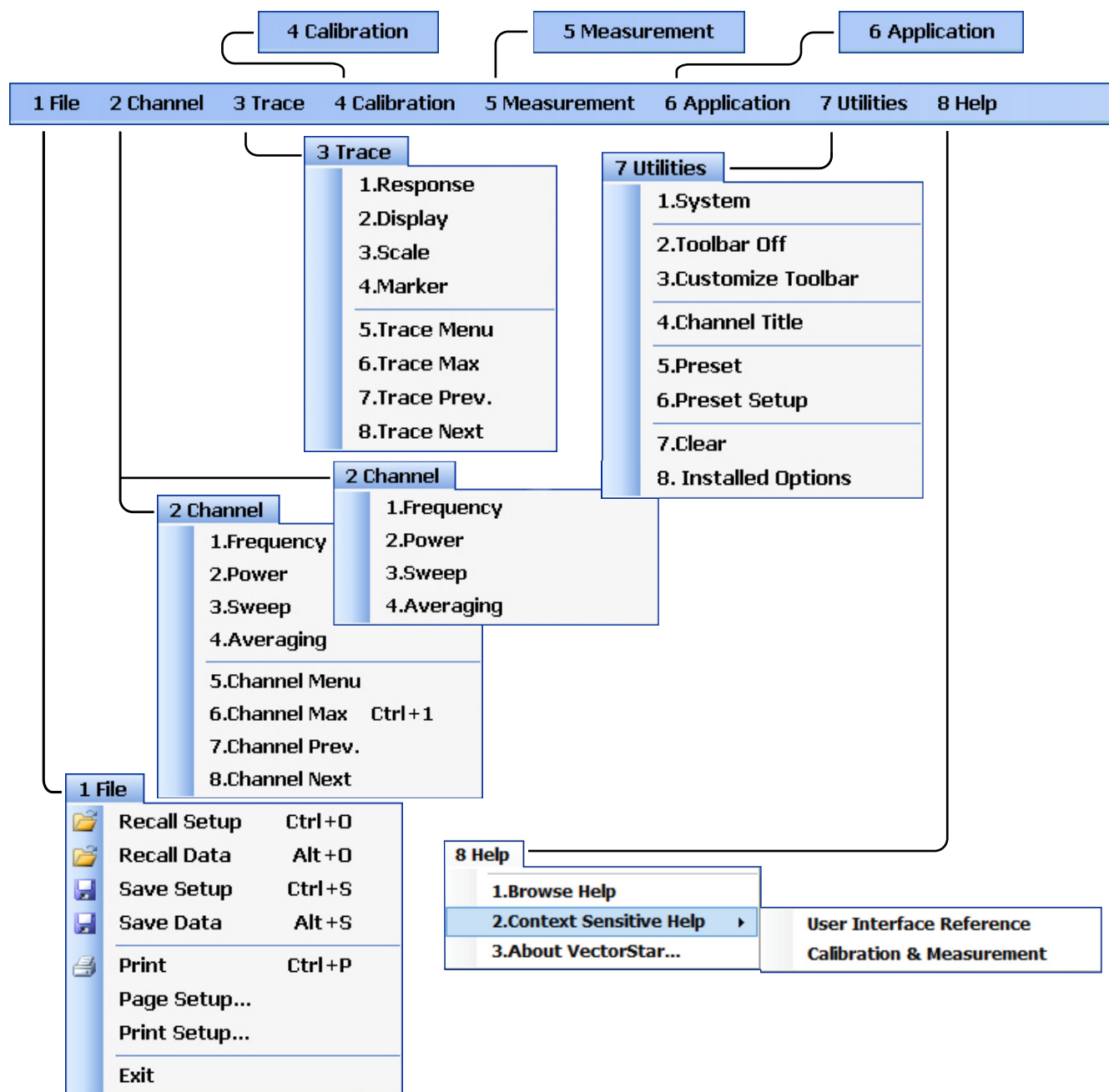


Figure 4-5. MENU BAR Major Functions, Drop-Down Menus, and Commands (1 of 2)

<p>The appearance of the <b>CHANNEL</b> menu depends on the instrument point mode.</p> <p>For all VectorStar VNA models, if the instrument is in 25,000 point mode, the <b>CHANNEL</b> menu has eight selections, as shown in the left CHANNEL menu.</p>	<p>For VectorStar VNA models, if the instrument is in 100,000 point mode, the <b>CHANNEL</b> menu has only four selections, as shown in the right CHANNEL menu.</p>
--	---

**Figure 4-5.** MENU BAR Major Functions, Drop-Down Menus, and Commands (2 of 2)

## Menu Bar General Operation

The MENU BAR drop-down menus and commands can be accessed by clicking on the menu bar and required command.

The keyboard can be used to enter the menu and/or command short cut, most of which use the **ALT (ALTERNATE)** key. To access a menu from the keyboard, press and hold the **ALT (ALTERNATE)** key and the number in front of the menu name.

- For example, **ALT+1** opens the FILE menu.
- For example, **ALT+7** opens the UTILITY menu.

To access most commands listed on the drop-down menus, follow the **ALT +** sequence with the menu command number.

- For example, to access the Preset command on the UTILITIES menu, enter **ALT+7**, then **5**.
- For example, to access the right side SYSTEM menu, enter **ALT+7**, then **1**.

Some MENU BAR menu commands can also be accessed by using the keyboard **Control (CTRL)** key. Press and hold the **CTRL** key and then the letter key.

- For example, to recall a previously saved setup, enter **CTRL + O** (letter O).
- For example, to print the current display screen, enter **CTRL + P**.

## Menu Bar Drop-Down Menus and Commands

The menu bar appears at the top of the instrument display and provides direct access to system menus and some button functions.



The table below summarizes all menu bar drop down commands and provides cross references to sections that describe the resultant menu or command in greater detail.

**Table 4-2.** Menu Bar Drop-Down Menu Descriptions (1 of 11)

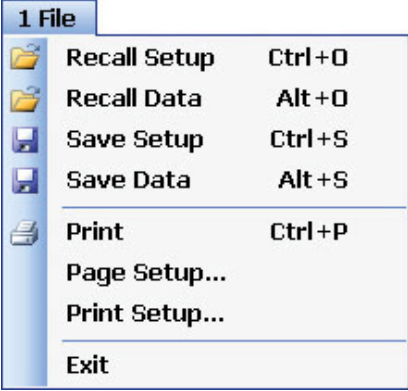
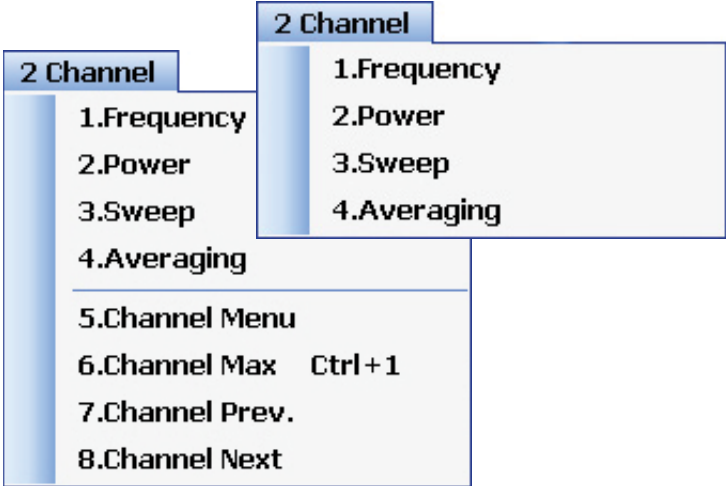
Menu and Command Name	Menu and Command Descriptions
<b>FILE Drop-Down Menu</b>	 <ul style="list-style-type: none"> <li>• Front Panel Key: <b>File</b></li> <li>• Keyboard: ALT + 1</li> <li>• MENU BAR   File</li> <li>• MAIN   File   FILE</li> </ul>
<b>Recall Setup Command</b>	<p>Select displays the RECALL SETUP dialog box and allows the recall of previously saved setup and/or calibration files:</p> <ul style="list-style-type: none"> <li>– Active Channel Setup and Calibration (.chx) File</li> <li>– Active Channel Setup (.stx) File</li> <li>– All Channel Setup (.sta) File</li> </ul> <ul style="list-style-type: none"> <li>• Keyboard: CTRL + O (letter O)</li> <li>• MENU BAR   File   Recall Setup</li> <li>• MAIN   File   FILE   Recall Setup   RECALL SETUP Dialog Box</li> </ul>
<b>Recall Data Command</b>	<p>Select displays the RECALL DATA dialog box and allows the recall of a previously saved active channel and/or active trace data file of these types:</p> <ul style="list-style-type: none"> <li>– Active Channel S2P (.s2p) File</li> <li>– Formatted Data into Active Trace (.tdf) File</li> <li>– Unformatted Data into Active Trace (.tdu) File</li> <li>– Formatted Data into Active Trace Memory (.tdf) File</li> <li>– Unformatted Data into Active Trace Memory (.tdu) File</li> </ul> <ul style="list-style-type: none"> <li>• Keyboard: Keyboard: ALT + O (letter O)</li> <li>• MENU BAR   File   Recall Data</li> <li>• MAIN   File   FILE   Recall Data   RECALL DATA Dialog Box</li> </ul>
<b>Save Setup Command</b>	<p>Select displays the Save Setup dialog box and allows the user to save the currently applied system presets configuration file.</p> <ul style="list-style-type: none"> <li>• Keyboard: CTRL + S</li> <li>• MENU BAR   File   Save Setup</li> <li>• MAIN   File   FILE   Save Setup   SAVE SETUP Dialog Box</li> </ul>

Table 4-2. Menu Bar Drop-Down Menu Descriptions (2 of 11)

Menu and Command Name	Menu and Command Descriptions
<b>Save Data Command</b>	<p>Select displays the SAVE DATA (Active Channel .txt) dialog box. Use this dialog to save the current channel data file.</p> <ul style="list-style-type: none"> <li>• Keyboard: ALT + S</li> <li>• MENU BAR   File   Save Data</li> <li>• MAIN   File   FILE   Save Data   SAVE DATA Dialog Box</li> </ul>
<b>Print Command</b>	<p>Select displays the Windows PRINT dialog box to print the current main display.</p> <ul style="list-style-type: none"> <li>• Keyboard: CTRL + P</li> <li>• MENU BAR   File   Print</li> <li>• MAIN   File   Print   PRINT Dialog Box</li> </ul>
<b>Page Setup Command</b>	<p>Select displays the Windows PAGE SETUP dialog box with controls for:</p> <ul style="list-style-type: none"> <li>• Paper size</li> <li>• Paper source tray at printer</li> <li>• Orientation as Portrait or Landscape</li> <li>• Margins for Left, Right, Top, and Bottom</li> </ul>
<b>Print Setup Command</b>	<p>Select displays the PRINT SETUP dialog box. The controls allow the print output to be customized as required. The following parameters can be set:</p> <p>Output Format – Select one of the following:</p> <ul style="list-style-type: none"> <li>• Bitmap with Page Setup</li> <li>• Graphical</li> <li>• Tabular</li> </ul> <p>Header Output:</p> <ul style="list-style-type: none"> <li>• Include Header – The header configuration set in the fields below can be included or left off print reports. Each field can be separately configured to be included or not.</li> <li>• Model – Provides an input field for model number information such as the DUT or VNA model.</li> <li>• Operator Name – Provides an input field for operator name or other identification.</li> <li>• Device ID – Provides an input field for the DUT identification.</li> <li>• Operator Comment – Provides a large free form input field for comments about the DUT or test.</li> </ul> <p>Logo Setup:</p> <ul style="list-style-type: none"> <li>• Include Logo – The logo set in the fields below can be included or left off print reports.</li> <li>• Select Logo Type – Anritsu – The default selection set an Anritsu logo or user defined logo in BMP graphics format.</li> <li>• Select Logo Type – User – If a user logo is selected, the graphic file must be copied onto the VectorStar VNA in a known location. Then use the Browse button to navigate to the logo file.</li> </ul>
<b>Exit Command</b>	<p>Select displays a confirmation dialog box. Click OK to exit the VectorStar application and return to the Windows desktop. Click Cancel to remain in the VectorStar application.</p> <ul style="list-style-type: none"> <li>• MENU BAR   File   Exit</li> </ul>

Table 4-2. Menu Bar Drop-Down Menu Descriptions (3 of 11)

Menu and Command Name	Menu and Command Descriptions
CHANNEL Drop-Down Menu	 <ul style="list-style-type: none"> <li>• CHANNEL menu for 25,000 point mode shown at left.</li> <li>• CHANNEL menu for 100,000 point mode short at right.</li> <li>• Front Panel Key: <b>Channel</b></li> <li>• Keyboard: ALT + 2</li> <li>• MENU BAR   Channel</li> <li>• MAIN   Channel   CHANNEL</li> </ul>
<b>Frequency</b>	Select displays the right-side FREQUENCY menu. <ul style="list-style-type: none"> <li>• Front Panel Key: <b>Frequency</b></li> <li>• Keyboard: ALT + 2 then 1</li> <li>• MENU BAR   Channel   Frequency</li> <li>• MAIN   Frequency   FREQUENCY</li> </ul>
<b>Power</b>	Select displays the right-side POWER menu. <ul style="list-style-type: none"> <li>• Front Panel Key: <b>Power</b></li> <li>• Keyboard: ALT + 2 then 2</li> <li>• MENU BAR   Channel   Power</li> <li>• MAIN   Power   POWER</li> </ul>
<b>Sweep</b>	Select displays the right-side SWEEP SETUP menu. <ul style="list-style-type: none"> <li>• Front Panel Key: <b>Sweep</b></li> <li>• Keyboard: ALT + 2, then 3</li> <li>• MENU BAR   Channel   Sweep</li> <li>• MAIN   Sweep Setup   SWEEP SETUP</li> </ul>
<b>Averaging</b>	Select displays the right-side AVERAGING menu. <ul style="list-style-type: none"> <li>• Front Panel Key: <b>Avg</b> (Average)</li> <li>• Keyboard: ALT + 2 then 4</li> <li>• MENU BAR   Channel   Averaging</li> <li>• MAIN   Averaging   AVERAGING</li> </ul>

**Table 4-2.** Menu Bar Drop-Down Menu Descriptions (4 of 11)

Menu and Command Name	Menu and Command Descriptions
<p><b>Channel Menu Command</b></p>	<p>Select displays the right-side CHANNEL menu.</p> <ul style="list-style-type: none"> <li>• Prerequisites: Instrument must be in 25,000 point mode.</li> <li>• Front Panel Key: <b>Channel</b></li> <li>• Keyboard: ALT + 2, then 5</li> <li>• MENU BAR   Channel   Channel Menu</li> <li>• MAIN   Channel   CHANNEL</li> </ul>
<p><b>Channel Max Command</b></p>	<p>Select maximizes the display of the active channel. Select again returns to the previous multi-channel display.</p> <ul style="list-style-type: none"> <li>• Prerequisites: Instrument must be in 25,000 point mode.</li> <li>• Keyboard: ALT + 2, then 6</li> <li>• Keyboard: CTRL + 1</li> <li>• MENU BAR   Channel   Channel Max</li> <li>• MAIN   Channel   CHANNEL   Chan. Max</li> </ul>
<p><b>Channel Previous Command</b></p>	<p>Selects the next lower channel number. If channel 1 was previously selected, selects the highest numbered channel.</p> <ul style="list-style-type: none"> <li>• Prerequisites: Instrument must be in 25,000 point mode.</li> <li>• Keyboard: ALT + 2, then 7</li> <li>• MENU BAR   Channel   Channel Prev.</li> <li>• MAIN   Channel   CHANNEL   Chan. Previous</li> </ul>
<p><b>Channel Next Command</b></p>	<p>Selects the next higher channel number. If the highest numbered channel was previously selected, selects channel 1.</p> <ul style="list-style-type: none"> <li>• Prerequisites: Instrument must be in 25,000 point mode.</li> <li>• Keyboard: ALT + 2, then 8</li> <li>• MENU BAR   Channel   Channel Next</li> <li>• MAIN   Channel   CHANNEL   Chan. Next</li> </ul>
<p><b>TRACE Drop-Down Menu</b></p>	<div data-bbox="852 1310 1203 1745" style="border: 1px solid black; padding: 5px; margin-bottom: 10px;"> <p><b>3 Trace</b></p> <ul style="list-style-type: none"> <li>1.Response</li> <li>2.Display</li> <li>3.Scale</li> <li>4.Marker</li> <hr style="width: 50%; margin: 5px auto;"/> <li>5.Trace Menu</li> <li>6.Trace Max</li> <li>7.Trace Prev.</li> <li>8.Trace Next</li> </ul> </div> <ul style="list-style-type: none"> <li>• Front Panel Key: <b>Trace</b></li> <li>• Keyboard: ALT + 3</li> <li>• MENU BAR   Trace</li> <li>• MAIN   Trace   TRACE</li> </ul>

Table 4-2. Menu Bar Drop-Down Menu Descriptions (5 of 11)

Menu and Command Name	Menu and Command Descriptions
<b>Response Command</b>	Select displays the right-side RESPONSE menu. <ul style="list-style-type: none"> <li>• Front Panel Key: <b>Response</b></li> <li>• Keyboard: ALT + 3 then 1</li> <li>• MENU BAR   Trace   Response</li> <li>• MAIN   Response   RESPONSE</li> </ul>
<b>Display Command</b>	Select displays the right-side DISPLAY menu. <ul style="list-style-type: none"> <li>• Front Panel Key: <b>Display</b></li> <li>• Keyboard: ALT + 3, then 2</li> <li>• MENU BAR   Trace   Display</li> <li>• MAIN   Display   DISPLAY</li> </ul>
<b>Scale Command</b>	Select displays the right-side SCALE menu. The name of the SCALE menu (and the buttons on it) depend on the display type selected such as: <ul style="list-style-type: none"> <li>– Scale (Log Mag)</li> <li>– Scale (Lin Mag)</li> <li>– Scale (Phase)</li> <li>– Scale (Real)</li> <li>– Scale (Imag)</li> <li>– Scale (SWR)</li> </ul> <ul style="list-style-type: none"> <li>• Front Panel Key: <b>Scale</b></li> <li>• Keyboard: ALT + 3, then 3</li> <li>• MENU BAR   Trace   Scale</li> <li>• MAIN   Scale   SCALE</li> </ul>
<b>Marker Command</b>	Select displays the right-side MARKERS [1] menu. <ul style="list-style-type: none"> <li>• Front Panel Key: <b>Marker</b></li> <li>• Keyboard: ALT + 3, then 4</li> <li>• MENU BAR   Trace   Marker</li> <li>• MAIN   Marker   MARKER [1]</li> </ul>
<b>Trace Menu Command</b>	Select displays the right-side TRACE menu. <ul style="list-style-type: none"> <li>• Front Panel Key: <b>Trace</b></li> <li>• Keyboard: ALT + 3, then 5</li> <li>• MENU BAR   Trace   Trace Menu</li> <li>• MAIN   Trace   TRACE</li> </ul>
<b>Trace Max Command</b>	Select maximizes the active trace to full screen display. Selecting again, returns the trace to the standard multi-trace display. <ul style="list-style-type: none"> <li>• Keyboard: ALT + 3, then 6</li> <li>• MENU BAR   Trace   Trace Max</li> <li>• MAIN   Trace   TRACE   Trace Max</li> </ul>

Table 4-2. Menu Bar Drop-Down Menu Descriptions (6 of 11)

Menu and Command Name	Menu and Command Descriptions
<b>Trace Previous Command</b>	<p>Selects the next lower trace number on the active channel. If Trace 1 is currently selected, the highest numbered trace is selected. If the current trace is not maximized, the previous trace will not be maximized. If the current trace is maximized, the previous trace will be maximized.</p> <ul style="list-style-type: none"> <li>• Keyboard: ALT + 3, then 7</li> <li>• MENU BAR   Trace   Trace Prev.</li> <li>• MAIN   Trace   TRACE   Trace Previous</li> </ul>
<b>Trace Next Command</b>	<p>Selects the next higher trace number on the active channel. If the highest numbered trace is currently displayed, the Trace 1 is displayed. If the current trace is not maximized, the next trace will not be maximized. If the current trace is maximized, the next trace will be maximized.</p> <ul style="list-style-type: none"> <li>• Keyboard: ALT + 3, then 8</li> <li>• MENU BAR   Trace   Trace Next</li> <li>• MAIN   Trace   TRACE   Trace Previous</li> </ul>
<b>CALIBRATION Drop-Down Menu</b>	<div style="text-align: center; border: 1px solid black; background-color: #e6f2ff; padding: 5px; width: fit-content; margin: 0 auto;"><b>4 Calibration</b></div> <p>The CALIBRATION drop-down menu has one command that selects the right-side CALIBRATION menu</p> <ul style="list-style-type: none"> <li>• Front Panel Key: <b>Calibration</b></li> <li>• Keyboard: ALT + 4</li> <li>• MENU BAR   Calibration</li> <li>• MAIN   Calibration   CALIBRATION</li> </ul>
<b>MEASUREMENT Drop-Down Menu</b>	<div style="text-align: center; border: 1px solid black; background-color: #e6f2ff; padding: 5px; width: fit-content; margin: 0 auto;"><b>5 Measurement</b></div> <p>Select displays the right-side MEASUREMENT menu.</p> <ul style="list-style-type: none"> <li>• Front Panel Key: <b>Measurement</b></li> <li>• Keyboard: ALT + 5</li> <li>• MENU BAR   Measurement</li> <li>• MAIN   Measurement   MEASUREMENT</li> </ul>
<b>APPLICATION Drop-Down Menu</b>	<div style="text-align: center; border: 1px solid black; background-color: #e6f2ff; padding: 5px; width: fit-content; margin: 0 auto;"><b>6 Application</b></div> <p>The APPLICATION menu/command selects the right-side APPLICATION menu.</p> <ul style="list-style-type: none"> <li>• Front Panel Key: <b>Application</b></li> <li>• Keyboard: ALT + 6</li> <li>• MENU BAR   Application</li> <li>• MAIN   Application   APPLICATION</li> </ul>

Table 4-2. Menu Bar Drop-Down Menu Descriptions (7 of 11)

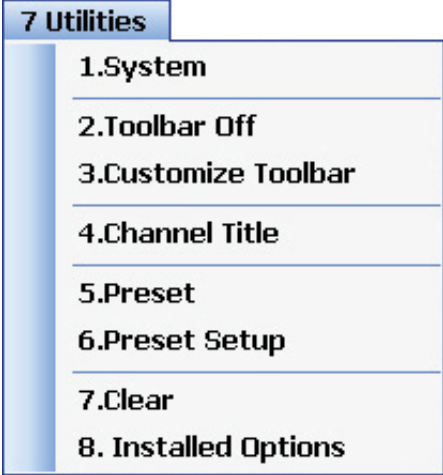
Menu and Command Name	Menu and Command Descriptions
UTILITY Drop-Down Menu	 <ul style="list-style-type: none"> <li>• Keyboard: ALT + 7</li> <li>• MENU BAR   Utilities</li> </ul>
<b>System Command</b>	<p>Select displays the right-side SYSTEM menu.</p> <ul style="list-style-type: none"> <li>• Front Panel Key: <b>System</b></li> <li>• Keyboard: ALT + 7, then 1</li> <li>• MENU BAR   Utilities   System</li> <li>• MAIN   System   SYSTEM</li> </ul>
<b>Toolbar Off Command</b>	<p>Toggles the ICON TOOLBAR, immediately below the MENU BAR, on and off.</p> <ul style="list-style-type: none"> <li>• Keyboard: ALT + 7, then 2</li> <li>• MENU BAR   Utilities   Toolbar Off</li> </ul>
<b>Customize Toolbar Command</b>	<p>Select displays the CUSTOMIZE TOOLBAR dialog box and allows the user to select which icons are to be displayed in the toolbar. Up to 10 icons can be displayed at one time and there are a total of 32 available icons. The Icon Toolbar configuration is saved when a Preset Save is completed.</p> <ul style="list-style-type: none"> <li>• Keyboard: ALT + 7, then 3</li> <li>• MENU BAR   Utilities   Customize Toolbar</li> </ul>
<b>Channel Title Command</b>	<p>Select displays the DISPLAY SETUP menu and allows a user-defined title to be applied to and displayed above the active channel. Each channel can have a different or the same title.</p> <ul style="list-style-type: none"> <li>• Keyboard: ALT + 7, then 4</li> <li>• MENU BAR   Utilities   Channel Title</li> <li>• MAIN   Display   DISPLAY   Display Area Setup   DISPLAY SETUP   Edit Chan. Title   EDIT CHANNEL TITLE Dialog Box</li> </ul>



Table 4-2. Menu Bar Drop-Down Menu Descriptions (8 of 11)

Menu and Command Name	Menu and Command Descriptions
<b>Preset Command</b>	<ul style="list-style-type: none"> <li>• Returns the instrument to its prior saved state which can be either the factory-default preset, or a user-defined setup. The PRESET SETUP menu selection defines which is used.</li> <li>• Front Panel Key: <b>Preset</b></li> <li>• Keyboard: ALT + 7, then 5</li> <li>• MENU BAR   Utilities   Preset</li> <li>• No right-side menu available to preset the instrument:               <ul style="list-style-type: none"> <li>– Use either the Front Panel <b>Preset</b> Key or the Menu Bar Function above.</li> </ul> </li> <li>• Navigation to the PRESET SETUP: MAIN   System   SYSTEM   Setup   SETUP   Preset Setup   PRESET SETUP</li> </ul>
<b>Preset Setup Command</b>	<p>Select displays the PRESET SETUP menu which allows the user to customize whether the preset function restores the instrument to:</p> <ul style="list-style-type: none"> <li>– User Defined: A previously saved user-defined state.</li> <li>– Default: The factory as-shipped state.</li> <li>– Default 0: The factory original setting.</li> </ul> <ul style="list-style-type: none"> <li>• Keyboard: ALT + 7, then 6</li> <li>• MENU BAR   Utilities   Preset Setup</li> <li>• MAIN   System   SYSTEM   Setup   SETUP   Preset Setup   PRESET SETUP</li> </ul>
<b>Clear Command</b>	<p>Select toggles the displayed right-side menu off and on. When toggled back on, the previously selected menu is displayed. For example, if the CALIBRATE function menu was displayed when the display was cleared, the CALIBRATE function menu is again displayed when Clear is selected a second time.</p> <ul style="list-style-type: none"> <li>• Keyboard: ALT + 7, then 7</li> <li>• MENU BAR   Utilities   Clear Command</li> </ul>

Table 4-2. Menu Bar Drop-Down Menu Descriptions (9 of 11)

Menu and Command Name	Menu and Command Descriptions
<p><b>Installed Option Command</b></p>	<p>Select displays the OPTION STATUS dialog box (with a typical display shown below) that lists all installed, included, and not installed instrument options. Click Close to clear.</p> <div data-bbox="480 369 1437 1083" style="border: 1px solid black; padding: 5px;"> <p>The screenshot shows a dialog box titled 'Option Status' with a list of options. Each option has a status icon: a green checkmark for installed options and a red X for non-installed options. The options listed are:</p> <ul style="list-style-type: none"> <li>Time Domain (Option 002) - Installed (Green checkmark)</li> <li>Receiver Offset (Option 007) - Installed (Green checkmark)</li> <li>V Connector (Option 011) - Not Installed (Red X)</li> <li>2.4 mm Connector (Option 012)^ - Not Installed (Red X)</li> <li>K Connector (Option 013) - Not Installed (Red X)</li> <li>3.5 mm Connector (Option 014)^ - Not Installed (Red X)</li> <li>N Connector (Option 015)^ - Not Installed (Red X)</li> <li>Universal Fixture Extraction (Option 021) - Installed (Green checkmark)</li> <li>Second Source (Option 031) - Installed (Green checkmark)</li> <li>RF Combiner (Option 032) - Not Installed (Red X)</li> <li>Digitizer Board (Option 035) - Not Installed (Red X)</li> <li>Expanded Digitizer Memory (Option 036) - Not Installed (Red X)</li> <li>Noise Figure (Option 041) - Installed (Green checkmark)</li> <li>PulseView™ (Option 042) - Installed (Green checkmark)</li> <li>True-Mode Stimulus (Option 043) - Installed (Green checkmark)</li> <li>IMDView™ (Option 044) - Installed (Green checkmark)</li> <li>Power Amplifier Linearizer (Option 045)^ - Not Installed (Red X)</li> <li>Fast CW (Option 046) - Installed (Green checkmark)</li> <li>Eye Diagram (Option 047) - Not Installed (Red X)</li> <li>Differential Noise Figure (Option 048) - Not Installed (Red X)</li> <li>Spectrum Analysis (Option 049) - Installed (Green checkmark)</li> <li>Direct Access Loops (Option 051) - Installed (Green checkmark)</li> <li>External ALC (Option 053) - Not Installed (Red X)</li> <li>Active Meas. Suite w/ 2 Step Attenuators (Option 061) - Not Installed (Red X)</li> <li>Active Meas. Suite w/ 4 Step Attenuators (Option 062) - Not Installed (Red X)</li> <li>70 kHz Low End Frequency Extension (Option 070) - Installed (Green checkmark)</li> <li>BB/mmWave (Option 080/081, 3739 Test Set) - Not Installed (Red X)</li> <li>mmWave (Option 082/083, 3739 Test Set) - Not Installed (Red X)</li> <li>Dual Source BB/mmWave (Option 084/085, 3739 Test Set) - Installed (Green checkmark)</li> <li>110 GHz BB/mmWave (Option 086/087/088/089, 3739 Test Set) - Not Installed (Red X)</li> </ul> <p>Footnote information at the bottom of the dialog:</p> <ul style="list-style-type: none"> <li>* N/A for this model</li> <li>** Included with other option</li> <li>*** Auto-detected from hardware</li> <li>^ Contact Factory for ordering information</li> </ul> <p>A 'Close' button is located at the bottom right of the dialog. Below the dialog, a URL is provided: <a href="http://www.anritsu.com/contact.asp">www.anritsu.com/contact.asp</a></p> </div> <ul style="list-style-type: none"> <li>• Keyboard: ALT + 7, then 8</li> <li>• MENU BAR   Utilities   Installed Options</li> <li>• MAIN   System   SYSTEM   Setup   SETUP   Misc. Setup   MISC. SETUP   Installed Options   OPTION STATUS Dialog Box</li> </ul>

Table 4-2. Menu Bar Drop-Down Menu Descriptions (10 of 11)

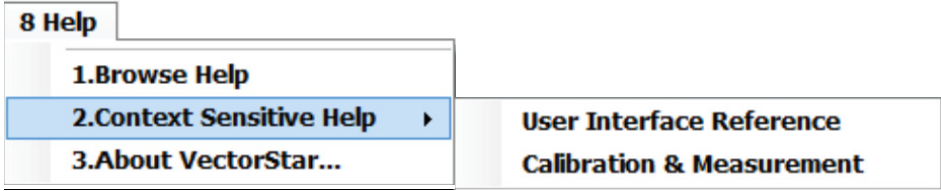
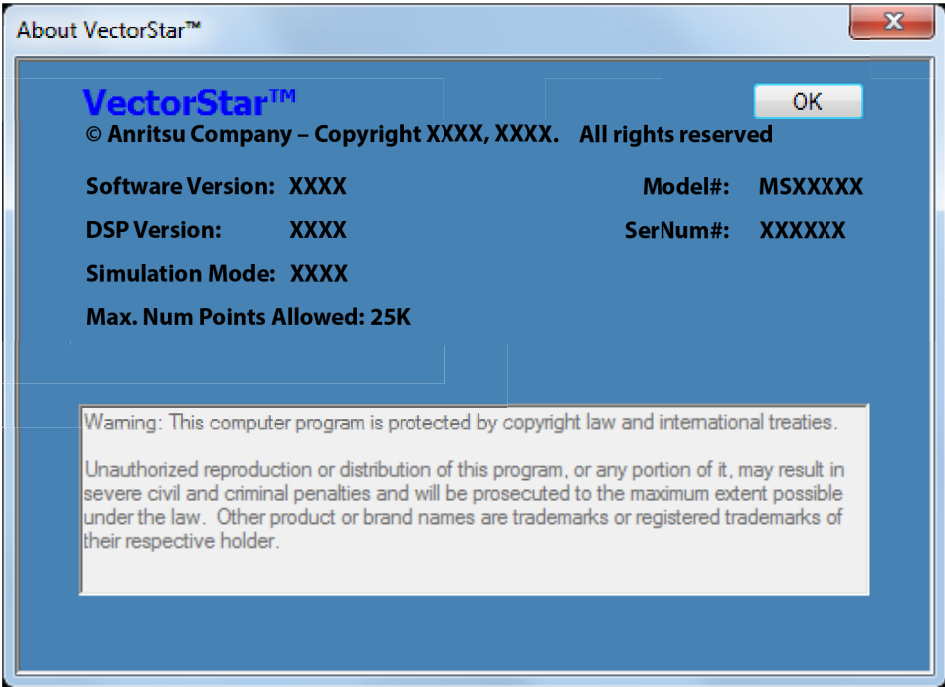
Menu and Command Name	Menu and Command Descriptions
<p><b>HELP Drop-Down Menu</b></p>	 <ul style="list-style-type: none"> <li>• Front Panel Key: Help</li> <li>• Keyboard: ALT + 8</li> <li>• MENU BAR   Help</li> </ul> <p>Selecting <b>User Interface Reference</b> takes the user to the section in the User Interface Reference Manual that is relevant to the current menu selected on the UI, where all details of the active menu and any related dialog boxes are explained.</p> <p>Selecting <b>Calibration &amp; Measurement</b> takes the user to the chapter landing page in the Measurement Guide that is relevant to the current menu selected on the UI. From there, the user can select the appropriate link on the landing page to take them to the section in the manual that discusses calibration or measurement topics that are related to the active menu.</p> <p>Note that when the active menu is not directly related to any calibration or measurement operations, Help takes the user to the Measurement Guide Cover page and contents bar for further browsing (if desired), or the user can switch back the User Interface Reference for more information about the menu.</p>
<p><b>Browse Help Command</b></p>	<p>Select displays the Help System, typically showing the help system table of contents and topics as an HTML page. The Help System navigation comprises the following main controls:</p> <p><b>Contents Tab</b> – The initial display is with Closed Book icons. Click the Closed Book icon to open it. An Open Book icon appears, listing its Content Topics below the icon. If a single-column topic appears without the left-side navigation functions, click the Show Navigation button to show the left-side navigation and search functions. Any topic can be saved to the Favorites Listing (described below) for rapid access. Click the top-right Printer icon to print the topic to an attached local or network printer.</p> <p><b>Search Tab</b> – The Search tab provides a search field for user entry of a keyword, phrase, or topic. Enter the term in the search field and click Go!. The search results appear in left-side Rank Title listing as Topic Links. Click a Topic Link of interest and the Topic appears in the in the right-side window with the search term highlighted.</p> <ul style="list-style-type: none"> <li>• Keyboard: ALT + 8, then 1</li> <li>• MENU BAR   Help   Browse Help</li> </ul>
<p><b>Context Sensitive Help Command</b></p>	<p>Select displays the context-sensitive help page based on the current right-side menu or topic. This is typically accessed by pressing the front panel Help key. Once enabled, a context-sensitive help page is displayed for each menu selected.</p> <ul style="list-style-type: none"> <li>• Front Panel Key: <b>Help</b></li> <li>• Keyboard: ALT + 8, then 2</li> <li>• MENU BAR   Help   Context Sensitive Help   User Interface Reference <b>-or-</b> Calibration &amp; Measurement</li> </ul>

Table 4-2. Menu Bar Drop-Down Menu Descriptions (11 of 11)

Menu and Command Name	Menu and Command Descriptions
<b>About VectorStar Command</b>	<p>Select displays the ABOUT VECTORSTAR dialog box with typical information as shown below. To access:</p> <ul style="list-style-type: none"> <li>• Keyboard: ALT + 8, then 3</li> <li>• MENU BAR   Help   About VectorStar...</li> </ul> <div data-bbox="472 417 1422 1100" style="border: 1px solid black; padding: 10px; margin: 10px 0;">  </div> <p>The dialog box provides instrument configuration information. Click OK to close the dialog box. The following information is provided:</p> <ul style="list-style-type: none"> <li>• Copyright Statement</li> <li>• Software Version</li> <li>• DSP Version</li> <li>• Model # (Model Number)</li> <li>• SerNum# (Serial Number)</li> <li>• Simulation Mode – Either True or False, depending upon whether the application is being run in simulation mode on a PC (True), or on a VectorStar VNA (False).</li> <li>• Max. Num Points Allowed (Maximum number of points allowed in current mode)</li> </ul>

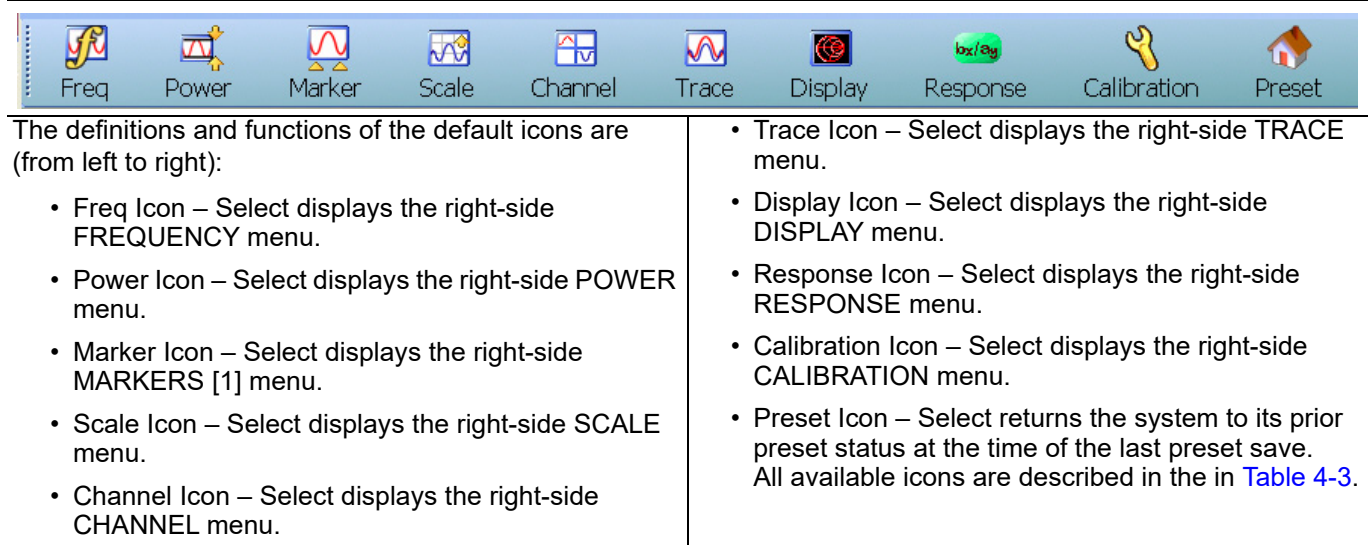
## 4-5 Icon Toolbar

### Overview

The Icon Toolbar is located immediately below the Menu Bar and allows single-click access to over 31 menus and functions. The icon toolbar is user-configurable and up to 10 icons be displayed at in any configuration.

### Using the Icon Toolbar Interface

The as-shipped factory default Icon Toolbar is shown below in [Figure 4-6](#).



**Figure 4-6.** Icon Toolbar with Factory Default Function Icons

### Available Icon Functions

The available icon functions that can be added to a user-defined icon toolbar are listed in table below. Once configured, a preset save allows the toolbar configuration to be recalled at any time.

The procedures for changing the icon toolbar are described following the icon table and uses the “[CUSTOMIZE \(ICON\) TOOLBAR Dialog Box](#)” on page 4-28 below. When a user-defined toolbar is configured, the first selected icon goes to the left-most position on the toolbar. The tenth selected icon goes to the right-most position on the toolbar.

**Table 4-3.** Icon Descriptions - Listed Alphabetically (1 of 6)







Icon Name	Icon	Description
<b>Icon Description Definitions</b>		<p><b>Default Icons</b> – These are one of the 10 default icons and are provided after a return to the factory standard configuration.</p> <p><b>Front Panel Key</b> – If available, the front panel hard key that accesses this menu or function.</p> <p><b>Keyboard</b> – If available, the keyboard shortcut to access this menu or function.</p> <p><b>Menu Bar</b> – If available, navigation path to access this menu or function.</p> <p><b>Navigation</b> – To navigate to this menu or function from the MAIN menu.</p> <p><b>Description</b> – If available, where this menu, dialog box, or function is described in greater detail in this document.</p>
<b>Application Icon</b>	 Application	<p>Select displays the right-side APPLICATION menu.</p> <ul style="list-style-type: none"> <li>• Front Panel Key: <b>Application</b></li> <li>• Keyboard: ALT + 6</li> <li>• Menu Bar: MENU BAR   6 Application   6 APPLICATION</li> <li>• MAIN   Application   APPLICATION</li> </ul>
<b>Average Icon</b>	 Average	<p>Select displays the right-side AVERAGING menu.</p> <ul style="list-style-type: none"> <li>• Front Panel Key: <b>Avg (Average)</b></li> <li>• Keyboard: ALT + 2, then 4</li> <li>• MENU BAR   Channel   Averaging</li> <li>• MAIN   Averaging   AVERAGING</li> </ul>
<b>Calibration Icon</b>	 Calibration	<p>Default Icon. Select displays the right-side CALIBRATION menu.</p> <ul style="list-style-type: none"> <li>• Front Panel Key: <b>Calibration</b></li> <li>• Keyboard: ALT + 4</li> <li>• MENU BAR   Calibration</li> <li>• MAIN   Calibration   CALIBRATION</li> </ul>
<b>Ch-&gt;Max Icon</b>	 Ch->Max	<p>When multiple channels are used, select activates and displays the channel with the maximum trace value.</p> <ul style="list-style-type: none"> <li>• MAIN   Channel   CHANNEL   Chan. Max</li> </ul>
<b>Ch-&gt;Next Icon</b>	 Ch->Next	<p>When multiple channels are used, select activates and displays the next higher channel number. If the highest channel number is currently active, channel 1 (one) is activated and displayed.</p> <ul style="list-style-type: none"> <li>• MAIN   Channel   CHANNEL   Chan. Next</li> </ul>
<b>Ch-&gt;Prev Icon</b>	 Ch->Prev	<p>When multiple channels are used, select activates and displays the next lower channel number. If channel 1 (one) is currently active, the highest numbered channel is activated and displayed.</p> <ul style="list-style-type: none"> <li>• MAIN   Channel   CHANNEL   Chan. Previous</li> </ul>

Table 4-3. Icon Descriptions - Listed Alphabetically (2 of 6)








Icon Name	Icon	Description
<b>Icon Description Definitions</b>		<p><b>Default Icons</b> – These are one of the 10 default icons and are provided after a return to the factory standard configuration.</p> <p><b>Front Panel Key</b> – If available, the front panel hard key that accesses this menu or function.</p> <p><b>Keyboard</b> – If available, the keyboard shortcut to access this menu or function.</p> <p><b>Menu Bar</b> – If available, navigation path to access this menu or function.</p> <p><b>Navigation</b> – To navigate to this menu or function from the MAIN menu.</p> <p><b>Description</b> – If available, where this menu, dialog box, or function is described in greater detail in this document.</p>
<b>Channel Icon</b>	 Channel	<p>Default Icon. Select displays the right-side CHANNEL menu.</p> <ul style="list-style-type: none"> <li>• Front Panel Key: <b>Channel</b></li> <li>• Keyboard: ALT + 2</li> <li>• MENU BAR   Channel   Channel Menu</li> <li>• MAIN   Channel   CHANNEL</li> </ul>
<b>Continue Icon</b>	 Continue	<p>After a system pause or hold with the Hold icon, the Continue icon resumes operation with all prior settings in effect.</p> <ul style="list-style-type: none"> <li>• MAIN   Sweep Setup   SWEEP SETUP   Hold Functions   HOLD FUNCTIONS   Continue</li> </ul>
<b>Custom Icon 1</b>		<p>Select performs the action defined for Custom Icon 1 using the right-side context menu. After definition, custom-action icons are displayed in the Icon Bar.</p> <p>The steps to define a Custom-action Icon are described in the <i>VectorStar MS464xB Series Microwave Vector Network Analyzer User Interface and Reference Manual</i> (10410-00319).</p>
<b>Custom Icon 2</b>		<p>Select performs the action defined for Custom Icon 2 using the right-side context menu. After definition, custom-action icons are displayed in the Icon Bar.</p> <p>The steps to define a Custom-action Icon are described in the <i>VectorStar MS464xB Series Microwave Vector Network Analyzer User Interface and Reference Manual</i> (10410-00319).</p>
<b>Custom Icon 3</b>		<p>Select performs the action defined for Custom Icon 3 using the right-side context menu. After definition, custom-action icons are displayed in the Icon Bar.</p> <p>The steps to define a Custom-action Icon are described in the <i>VectorStar MS464xB Series Microwave Vector Network Analyzer User Interface and Reference Manual</i> (10410-00319).</p>
<b>Custom Icon 4</b>		<p>Select performs the action defined for Custom Icon 4 using the right-side context menu. After definition, custom-action icons are displayed in the Icon Bar.</p> <p>The steps to define a Custom-action Icon are described in the <i>VectorStar MS464xB Series Microwave Vector Network Analyzer User Interface and Reference Manual</i> (10410-00319).</p>
<b>Custom Icon 5</b>		<p>Select performs the action defined for Custom Icon 5 using the right-side context menu. After definition, custom-action icons are displayed in the Icon Bar.</p> <p>The steps to define a Custom-action Icon are described in the <i>VectorStar MS464xB Series Microwave Vector Network Analyzer User Interface and Reference Manual</i> (10410-00319).</p>



Table 4-3. Icon Descriptions - Listed Alphabetically (3 of 6)








Icon Name	Icon	Description
<b>Icon Description Definitions</b>		<p><b>Default Icons</b> – These are one of the 10 default icons and are provided after a return to the factory standard configuration.</p> <p><b>Front Panel Key</b> – If available, the front panel hard key that accesses this menu or function.</p> <p><b>Keyboard</b> – If available, the keyboard shortcut to access this menu or function.</p> <p><b>Menu Bar</b> – If available, navigation path to access this menu or function.</p> <p><b>Navigation</b> – To navigate to this menu or function from the MAIN menu.</p> <p><b>Description</b> – If available, where this menu, dialog box, or function is described in greater detail in this document.</p>
<b>Display Icon</b>	 Display	Default Icon. Select displays the right-side DISPLAY menu. <ul style="list-style-type: none"> <li>• Front Panel Key: <b>Display</b></li> <li>• Keyboard: ALT + 3, then 2</li> <li>• MENU BAR   Trace   Display</li> <li>• MAIN   Trace   TRACE</li> </ul>
<b>File Icon</b>	 File	Select displays the right-side FILE menu. <ul style="list-style-type: none"> <li>• Front Panel Key: <b>File</b></li> <li>• Keyboard: ALT + 1</li> <li>• MAIN   File   FILE</li> </ul>
<b>Freq Icon</b>	 Freq	Default Icon. Select displays the right-side FREQUENCY menu. <ul style="list-style-type: none"> <li>• Front Panel Key: <b>Frequency</b></li> <li>• Keyboard: ALT + 2 then 1</li> <li>• MENU BAR   Channel   Frequency</li> <li>• MAIN   Frequency   FREQUENCY</li> </ul>
<b>Help Icon</b>	 Help	Select displays the context-sensitive HELP system for the current instrument menu display. Click OK to clear. <ul style="list-style-type: none"> <li>• Front Panel Key: <b>Help</b></li> <li>• Keyboard:               <ul style="list-style-type: none"> <li>– ALT + 8, then 1</li> <li>– ALT + 8, then 2</li> </ul> </li> <li>• MENU BAR   Help   Context Sensitive Help</li> </ul>
<b>Hold Icon</b>	 Hold	Select pauses the system operation, retaining all system presets and current configuration settings. <ul style="list-style-type: none"> <li>• MAIN   Sweep Setup   SWEEP SETUP   Hold Functions   HOLD FUNCTIONS   Hold</li> </ul>
<b>Marker-&gt;Max Icon</b>	 Marker->Max	Displays marker with maximum value. <ul style="list-style-type: none"> <li>• MAIN   Marker   MARKER [1]   Marker Search   MARKER SEARCH   Max</li> </ul>
<b>Marker-&gt;Min Icon</b>	 Marker->Min	Select displays the marker with minimum value. <ul style="list-style-type: none"> <li>• MAIN   Marker   MARKER [1]   Marker Search   MARKER SEARCH   Min</li> </ul>

Table 4-3. Icon Descriptions - Listed Alphabetically (4 of 6)








Icon Name	Icon	Description
<b>Icon Description Definitions</b>		<p><b>Default Icons</b> – These are one of the 10 default icons and are provided after a return to the factory standard configuration.</p> <p><b>Front Panel Key</b> – If available, the front panel hard key that accesses this menu or function.</p> <p><b>Keyboard</b> – If available, the keyboard shortcut to access this menu or function.</p> <p><b>Menu Bar</b> – If available, navigation path to access this menu or function.</p> <p><b>Navigation</b> – To navigate to this menu or function from the MAIN menu.</p> <p><b>Description</b> – If available, where this menu, dialog box, or function is described in greater detail in this document.</p>
<b>Marker-&gt;Off Icon</b>	 Marker->Off	<p>Select turns all marker displays off.</p> <ul style="list-style-type: none"> <li>MAIN   Marker   MARKER [1]   Marker Setup   MARKER SETUP   All Markers Off</li> </ul>
<b>Marker-&gt;Peak Icon</b>	 Marker->Peak	<p>Select displays marker with the highest peak value.</p> <ul style="list-style-type: none"> <li>MAIN   Marker   MARKER [1]   Marker Search   MARKER SEARCH   Peak   PEAK   Search Peak</li> </ul>
<b>Marker-&gt;Pk Lft Icon</b>	 Marker->Pk Lft	<p>Select displays the next peak value marker to the left of current selected marker.</p> <ul style="list-style-type: none"> <li>MAIN   Marker   MARKER [1]   Marker Search   MARKER SEARCH   Peak   PEAK   Search Left</li> </ul>
<b>Marker-&gt;Pk Rt Icon</b>	 Marker->Pk Rt	<p>Select moves the current active marker to the next trace peak value to the right of its current position.</p> <ul style="list-style-type: none"> <li>MAIN   Marker   MARKER [1]   Marker Search   MARKER SEARCH   Peak   PEAK   Search Right</li> </ul>
<b>Marker Icon</b>	 Marker	<p>Default Icon. Select displays the right-side MARKERS [1] menu.</p> <ul style="list-style-type: none"> <li>Front Panel Key: <b>Marker</b></li> <li>Keyboard: ALT + 3, then 4</li> <li>MENU BAR   Trace   Marker</li> <li>MAIN   Marker   MARKER [1]</li> </ul>
<b>Measurement Icon</b>	 Measurement	<p>Select displays the right-side MEASUREMENT menu.</p> <ul style="list-style-type: none"> <li>Front Panel Key: <b>Measurement</b></li> <li>Keyboard: ALT + 5</li> <li>MENU BAR   Measurement   5 MEASUREMENT</li> <li>MAIN   Measurement</li> </ul>
<b>Power Icon</b>	 Power	<p>Default Icon. Select displays the right-side POWER menu.</p> <ul style="list-style-type: none"> <li>Front Panel Key: <b>Power</b></li> <li>Keyboard Equivalent: ALT + 2, then 2</li> <li>MENU BAR   Channel   Power</li> <li>MAIN   Power   POWER</li> </ul>

Table 4-3. Icon Descriptions - Listed Alphabetically (5 of 6)











Icon Name	Icon	Description
<b>Icon Description Definitions</b>		<p><b>Default Icons</b> – These are one of the 10 default icons and are provided after a return to the factory standard configuration.</p> <p><b>Front Panel Key</b> – If available, the front panel hard key that accesses this menu or function.</p> <p><b>Keyboard</b> – If available, the keyboard shortcut to access this menu or function.</p> <p><b>Menu Bar</b> – If available, navigation path to access this menu or function.</p> <p><b>Navigation</b> – To navigate to this menu or function from the MAIN menu.</p> <p><b>Description</b> – If available, where this menu, dialog box, or function is described in greater detail in this document.</p>
<b>Preset Icon</b>	 Preset	<p>Default Icon. Select returns the system to its prior preset status which is the status at the time of the last preset save.</p> <ul style="list-style-type: none"> <li>• Front Panel Key: <b>Preset</b></li> <li>• Keyboard: ALT + 7, then 5</li> <li>• MENU BAR   Utilities   Preset</li> </ul> <p>The instrument preset function is only available from the MENU BAR and the instrument front panel key. To setup the preset function, use the PRESET SETUP menu described at the locations below:</p> <ul style="list-style-type: none"> <li>• MAIN   System   SYSTEM   Preset Setup   PRESET SETUP</li> </ul>
<b>Print Icon</b>	 Print	<p>Select displays the PRINT dialog box, usually to print a copy of the main display. Once the dialog box appears, click OK to print; click Cancel to abort.</p> <ul style="list-style-type: none"> <li>• MENU BAR   File   Print</li> <li>• MAIN   File   FILE   Print   PRINT Dialog Box</li> </ul>
<b>Response Icon</b>	 Response	<p>Default Icon. Select displays the right-side RESPONSE menu.</p> <ul style="list-style-type: none"> <li>• Front Panel Key: <b>Response</b></li> <li>• Keyboard: ALT + 3, then 1</li> <li>• MENU BAR   Trace   Response</li> <li>• MAIN   Response   RESPONSE</li> </ul>
<b>Scale Icon</b>	 Scale	<p>Default Icon. Select displays the right-side SCALE menu.</p> <ul style="list-style-type: none"> <li>• Front Panel Key: <b>Scale</b></li> <li>• Keyboard: ALT + 3, then 3</li> <li>• MENU BAR   Trace   Scale</li> <li>• Main   Scale   SCALE</li> </ul>
<b>Sweep Icon</b>	 Sweep	<p>Select displays the right-side SWEEP SETUP menu.</p> <ul style="list-style-type: none"> <li>• Front Panel Key: <b>Sweep</b></li> <li>• Keyboard: ALT + 2, then 2</li> <li>• MENU BAR   Channel   Sweep</li> <li>• MAIN   Sweep   SWEEP</li> </ul>
<b>System Icon</b>	 System	<p>Select displays the right-side SYSTEM menu.</p> <ul style="list-style-type: none"> <li>• Front Panel Key: <b>System</b></li> <li>• Keyboard: ALT + 7, then 1</li> <li>• MENU BAR   Utilities   System</li> <li>• MAIN   System   SYSTEM</li> </ul>

Table 4-3. Icon Descriptions - Listed Alphabetically (6 of 6)

Icon Name	Icon	Description
<b>Icon Description Definitions</b>		<p><b>Default Icons</b> – These are one of the 10 default icons and are provided after a return to the factory standard configuration.</p> <p><b>Front Panel Key</b> – If available, the front panel hard key that accesses this menu or function.</p> <p><b>Keyboard</b> – If available, the keyboard shortcut to access this menu or function.</p> <p><b>Menu Bar</b> – If available, navigation path to access this menu or function.</p> <p><b>Navigation</b> – To navigate to this menu or function from the MAIN menu.</p> <p><b>Description</b> – If available, where this menu, dialog box, or function is described in greater detail in this document.</p>
<b>Tr-&gt;Max Icon</b>	 Tr->Max	Select maximizes the display with the currently active trace. <ul style="list-style-type: none"> <li>• Keyboard: ALT + 3, then 6</li> <li>• MENU BAR   Trace   Trace Max</li> <li>• MAIN   Trace   TRACE   Trace Max</li> </ul>
<b>Tr-&gt;Next Icon</b>	 Tr->Next	Select displays the next higher trace number. When the highest trace number is reached, the next click displays trace number 1 (one). <ul style="list-style-type: none"> <li>• Keyboard: ALT + 3, then 8</li> <li>• MENU BAR   Trace   Trace Next</li> <li>• MAIN   Trace   TRACE   Trace Next</li> </ul>
<b>Tr-&gt;Previous Icon</b>	 Tr->Previous	Select displays the next lower trace number. When the lowest trace number 1 is reached, the next click displays the highest numbered trace. <ul style="list-style-type: none"> <li>• Keyboard: ALT + 3 then 7</li> <li>• MENU BAR   Trace   Trace Prev.</li> <li>• MAIN   Trace   TRACE   Trace Previous</li> </ul>
<b>Trace Icon</b>	 Trace	Default Icon. Select displays the right-side TRACE menu. <ul style="list-style-type: none"> <li>• Front Panel Key: <b>Trace</b></li> <li>• Keyboard: ALT + 3, then 5</li> <li>• MENU BAR   Trace   Trace Menu</li> <li>• MAIN   Trace   TRACE</li> </ul>

## CUSTOMIZE (ICON) TOOLBAR Dialog Box

Use the CUSTOMIZE TOOLBAR dialog box to setup the Icon Toolbar with the icons you need for quick access to commands and functions. Once configured, and after a Preset Configuration save, the Icon Toolbar settings can be recalled with the other preset configuration parameters.

### Previous

- “UTILITY Drop-Down Menu” on page 4-16

### Keyboard

- ALT + 7, then 3

### Navigation

- MENU BAR | Utilities | Customize Toolbar | CUSTOMIZE TOOLBAR Dialog Box

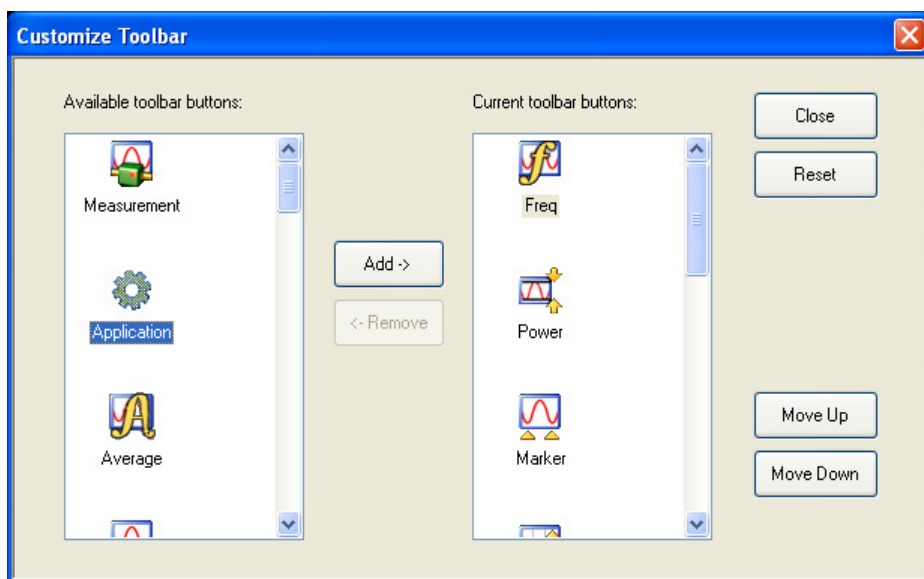


Figure 4-7. CUSTOMIZE TOOLBAR Dialog Box

### Procedure

With the CUSTOMIZE TOOLBAR dialog box open, the left-side Available Toolbar Buttons area shows icons that are not in use on the current toolbar, while the right-side Current Toolbar Buttons area shows the current in-use icons.

### Removing Icons

1. To change the icons in the current icon toolbar, in the right side Current button area, select an icon to remove. When selected, the Add-> and <-Remove buttons become available.
2. Remove unwanted icons as required by selecting the icon and then clicking the <-Remove button.
3. Removed icons appear at the bottom of the Available Toolbar Buttons list.

### Adding Icons

1. Scroll through the Available Toolbar Buttons list and select an icon to add, then click the Add-> button. The selected icon appears in the right side Current Toolbar Buttons area.
2. Repeat the selection process until all required icons listed in the right side Current Toolbar Buttons area or you have reached the maximum of 10 icons.
3. In the Current Toolbar Button display, the icon displayed at the top of the list will appear on the extreme left of the toolbar. The tenth icon displayed at the bottom of the list will appear on the extreme right of the toolbar.

### Moving Icons

To change the left to right sequence of the current icons, select an icon, and click the Move Up/Move Down buttons until the icons are correctly positioned left to right.

### Saving the Configuration

When the icons are in the correct sequence. Click the **Close** button to apply the icons to the icon toolbar. It is recommended that a **Preset Save** be performed to save the icon toolbar configuration. If the icon toolbar needs adjustment, re-open the **Customize Toolbar** dialog box and repeat the steps above.

### Reset to Factory Default

To return the icon toolbar to its factory default state, click the **Reset** button.

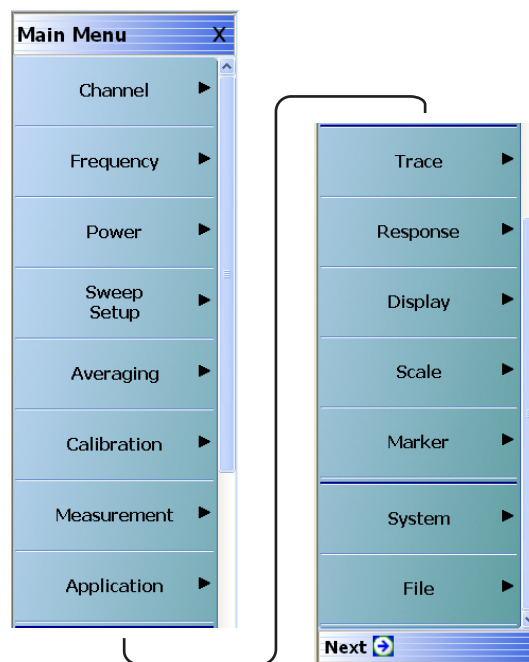
## 4-6 MAIN Menu and Application Menus

This section summarizes the MAIN menu which is the home menu for all right-side menu interface menus, dialog boxes, and functions.

Below each menu button name is a link to the individual chapter/help topic that describes that menu and its related submenus in greater detail. For example, the **Frequency** button which calls the FREQUENCY related menus, toolbars, and dialog boxes links to the detailed descriptions in the **User Interface Reference Manual** under the description of each menu set.

Note that the actual instrument MAIN menu is longer than the display height and is accessed through the use of side scroll-bars.

### MAIN Menu



**Figure 4-8.** MAIN Menu

#### Channel

Select displays the CHANNEL menu.

- See in the **User Interface Reference Manual** and the description of the CHANNEL menu.

**Frequency**

Select displays the FREQUENCY menu. See in the **User Interface Reference Manual** and the description of the FREQUENCY menus for a general description of the menus. There, each FREQUENCY menu variant is described in greater detail.

**Power**

Select displays the POWER menu. The POWER menus change depending both the sweep type selected and whether the VNA in 2-Port mode or in 4-Port mode. See the **User Interface Reference Manual** and the description of the 2-Port and 4-Port Power menus.

**Sweep Setup**

Select displays the SWEEP SETUP menu.

**Averaging**

Select displays the AVERAGING menu.

**Calibration**

Select displays the CALIBRATION menu. The menu version displayed depends on whether the VNA is in 2-Port or 4-Port Mode.

**Measurement**

Displays the MEASUREMENT menu.

**Application**

Displays the APPLICATION menu.

**Trace**

Displays the TRACE menu.

**Response**

Displays the RESPONSE menu. The menu version displayed depends on whether the VNA is in 2-Port or 4-Port Mode.

**Display**

Displays the DISPLAY menu.

**Scale**

Displays the SCALE menu. The SCALE menu has variants depending on the trace type selected. See the SCALE menu chapter in the **User Interface Reference Manual**.

**Marker**

Select displays the MARKER [1] menu.

**System**

Select displays the SYSTEM menu.

**File**

Select displays the FILE menu.

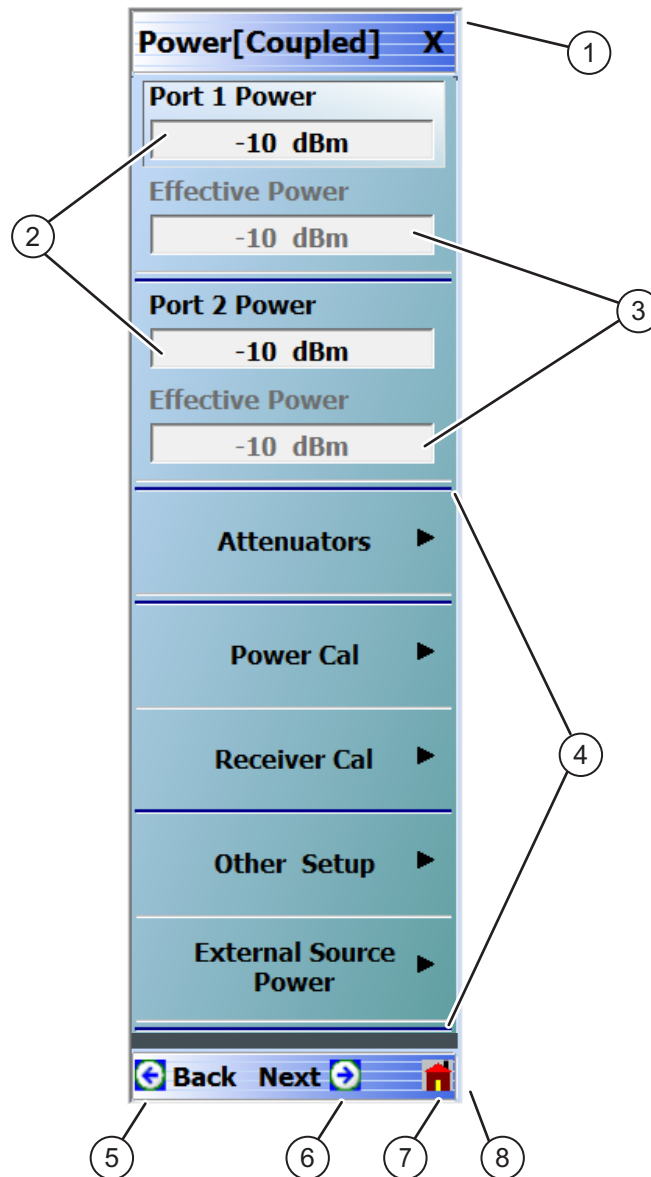
The rest of this chapter describes the operation of the interface.



## 4-7 Using the Main Menu Interface

### Types of Menus, Menu Buttons, and Menu Toolbars

The Main Menu (or MAIN) is the right-side navigation function for the instrument. The Main Menu has multiple types of menus, menu buttons, and menu toolbars that allow the user to configure and control the operation of the VNA. Each menu consists of the elements shown in the figure below.



- |  |  |
|--|--|
| 1. Menu Title – Each menu title is unique.   | 5. Back Button – Returns to a higher-level menu.   |
| 2. Field Buttons – The button shows the currently selected value. Selecting the button displays a field toolbar. | 6. Next Button – If available, displays a sub-menu that has been already selected.                         |
| 3. Display Buttons – Read-only calculated display based on parameters entered at other buttons and toolbars.     | 7. Home Button – Returns to the MAIN menu.   |
| 4. Menu Buttons – Displays a menu or dialog box.   | 8. Scroll Bar – Not shown in this example, long menus have a right-side scroll bar to display all options. |

**Figure 4-9.** Menu and Button Components

## Menu Title

At the top of the menu, a unique menu title, which is not repeated on any other menu. For space reasons, menu names are often abbreviated. For definitions, see [Appendix D, “Terms and Abbreviations Glossary”](#).

## Menu Buttons

One or more menu buttons that either call a sub-menu, allow for a field value to be specified, toggle a function off or on, or allow a selection to be made from a group of choices. If the menu is longer than one screen, a scroll box and scroll arrows appear on the right side of the menu.

## Menu Navigation Buttons

The menu navigation area buttons appear at the bottom of each menu.



## Back Button

The Back button returns the menu display to last selected higher-level menu.

## Next Button

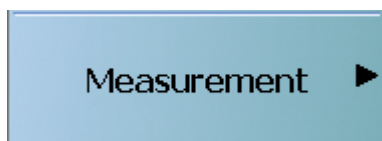
The Next button returns the menu display to the next deeper sub-menu that has already been selected. The availability of the Back and Next buttons (above) depends on the user's navigation path. The Home button (below) always appears.

## Home Button

The Home button returns the menu display to the MAIN menu.

## Menu Buttons

Menu buttons call lower-level menus.



For example, the Measurement button on the MAIN menu calls the MEASUREMENT menu. Most button names show the name of the called sub-menu.

## Display Button

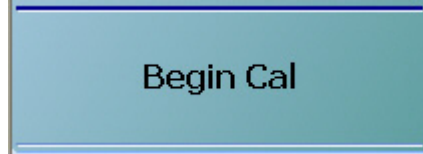
Read-only display buttons show system values based on other settings and parameters.



For example, the Step Size display button shows the step size for each point based on a frequency span of 70 GHz using 100 measuring points.

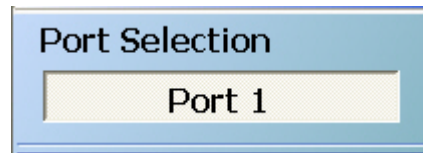
## Plain Buttons

Plain buttons start a process or display an operating system dialog box. If they start a process, the button is usually dimmed while the process is running, and when complete, the button is returned to normal brightness.

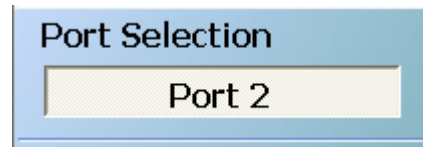


## Toggle Buttons

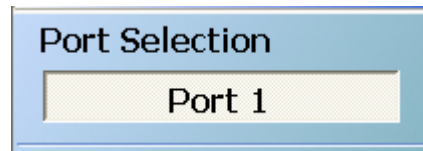
Toggle buttons cycle through two or more values with each click of the button and display their current setting in the button field. For example, in the POWER CALS menu, the Port Selection button displays an initial setting of Port 1.



Clicking the Port Selection button selects Port 2.

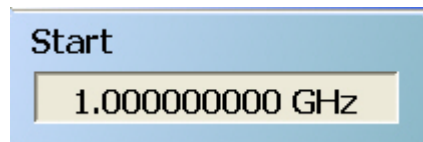


Clicking the Port Selection button a second time returns the setting to Port 1.



## Field Selection Buttons

Field selection buttons display a user-defined parameter or value. Clicking a field selection button such as the Start button on the FREQUENCY menu displays a field toolbar (described below) that allows the user to specify parameter values and units.



## Field Toolbars

Field toolbars appear under the Icon Toolbar after their field button has been selected. The field toolbar displays its name, a value field, up/down arrows to increment the value, and one or more unit select buttons.

<ol style="list-style-type: none"> <li>1. Toolbar Name – The toolbar name usually is based on the name of the button that called the toolbar.</li> <li>2. Value Field – Entry area for parameter value. Entry can be from the front panel Number Keys, or from an attached USB keyboard, or by clicking the Up/Down arrows (below).</li> <li>3. Up/Down Arrows – Increments the value field up or down to quickly enter values. The same effect from the front panel Up/Down Arrow Keys, or from the keyboard Up/Down arrow keys.</li> </ol>	<ol style="list-style-type: none"> <li>4. Available Units Selection – If available (shown in the upper toolbar), allows the selection of units from two or more values. If not available (shown in the lower toolbar), the units are fixed and not selectable.</li> <li>5. Close X – Closes the toolbar and returns the selected value to the field button that called the toolbar.</li> </ol>
--	--

**Figure 4-10.** Field Toolbar Selections

For example, clicking the Start button on the FREQUENCY menu displays the Start (Frequency) field toolbar.



Some field toolbars have units that cannot be changed. For example, clicking the Port 1 Power button on the POWER menu displays the Port 1 Power field toolbar with units fixed as dBm.



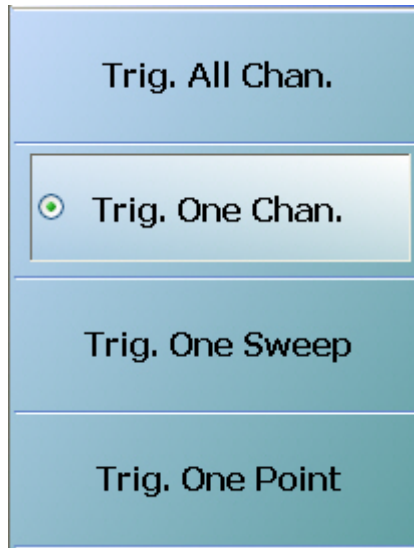
The system limits for each toolbar are defined in the System Limits section in the Programming Manual Supplement. The appendix lists the default, minimum allowable, and maximum allowable values and whether the toolbar changes apply on a per-trace, per-channel, or per-system basis.

## Button Selection Icon

The button select icon identifies a selected option.



For example, on the MANUAL TRIGGER menu below, the Trig. One Chan. (Trigger One Channel) option has been selected.



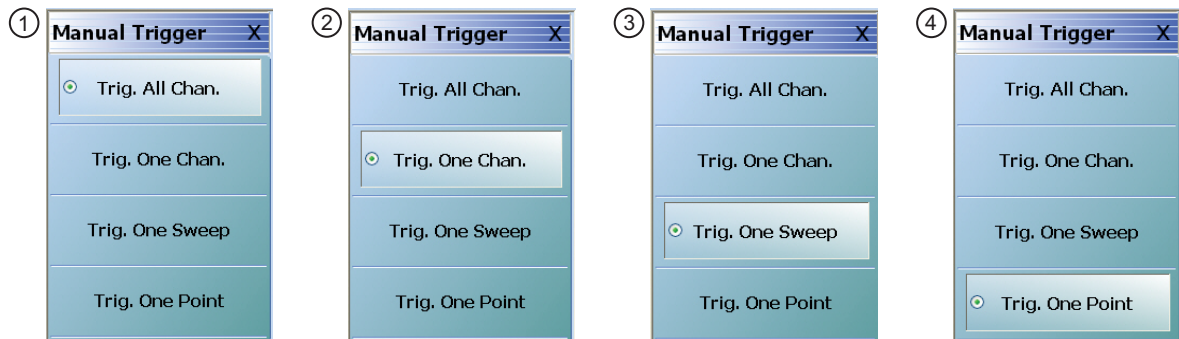
After selection, depending on the menu, the user either clicks the **Back** button navigation icon to return to the prior menu, or once selected, the system auto-returns to the prior menu.

**Navigation**

- MAIN | Sweep Setup | SWEEP SETUP | Trigger | TRIGGER | Manual Trigger Setup | MANUAL TRIGGER

**Button Selection Groups**

Button selection groups (also called a “radio button group”) allow the user to make one selection from two or more possible options. The selection of any one button de-selects all other buttons in the group. For example, the MANUAL TRIGGER menu is a button selection group with four (4) buttons.



After making the selection, use the **Back** button to return to the previous menu.

1. Trigger All Channels button selected.

2. Trigger One Channel button selected.

3. Trigger One Sweep button selected.

4. Trigger One Point button selected.

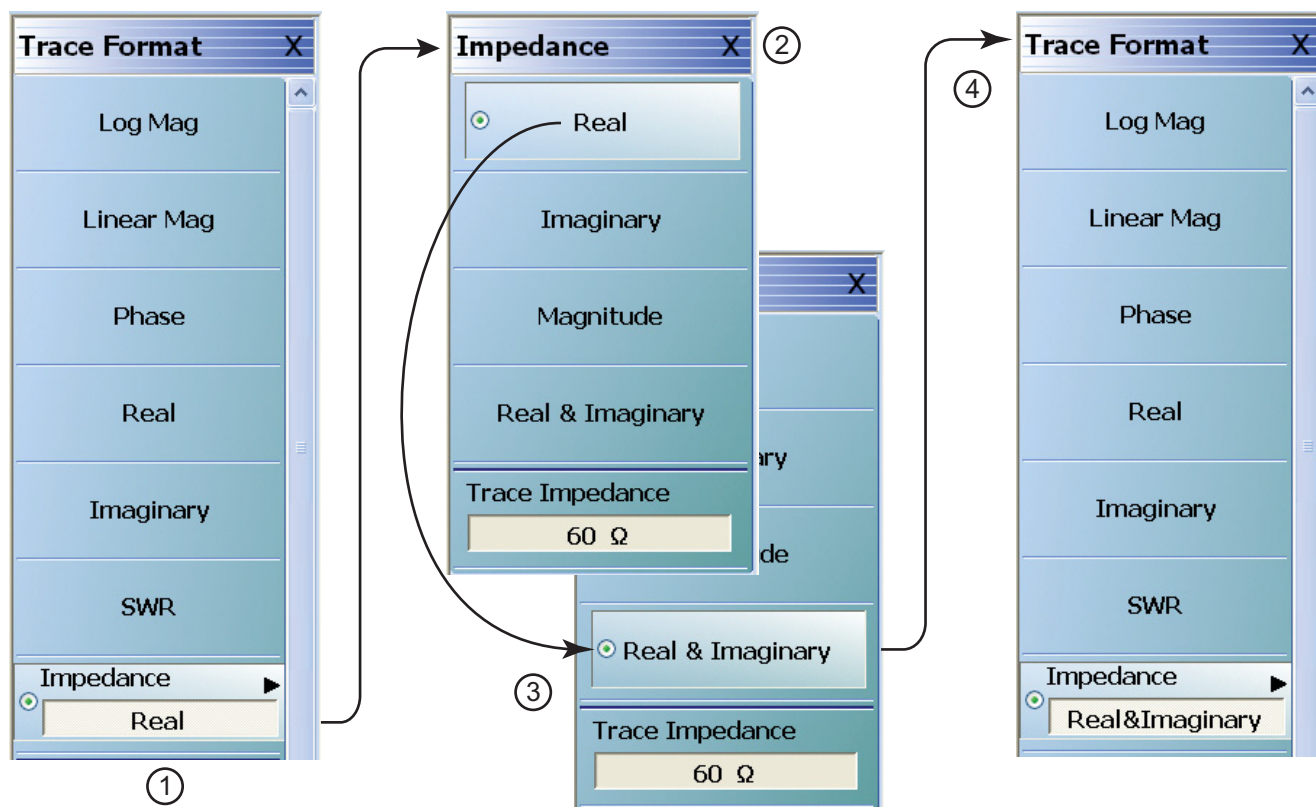
**Figure 4-11.** Button Selection Group Example on the MANUAL TRIGGER Menu

After a selection has been made, the button is identified with the selection icon. The user returns to the prior menu by clicking the **Back** navigation button. In some menus, after a selection is made, the system auto-returns to the previous menu (described below).

## Auto-Return Button Groups

Auto-return groups are button selection groups (described above) that automatically return to the higher-level menu after a selection is made.

For example, on the TRACE FORMAT menu shown below (1), clicking on the Impedance button displays the IMPEDANCE menu with its current selection of Real (2). When another selection such as Real & Imaginary is made (3), the system auto-returns to the TRACE FORMAT menu with the Impedance button now set to Real & Imaginary (4).



- |  |  |
|--|--|
| <ol style="list-style-type: none"> <li>1. Original TRACE FORMAT Menu with Impedance setting as "Real" <ul style="list-style-type: none"> <li>• The bottom Impedance field button is set to "Real"</li> <li>• Clicking the Impedance button displays the IMPEDANCE menu.</li> </ul> </li> <li>2. Original IMPEDANCE Menu with "Real" <ul style="list-style-type: none"> <li>• The IMPEDANCE menu appears with impedance set as "Real."</li> </ul> </li> </ol> | <ol style="list-style-type: none"> <li>3. IMPEDANCE Menu with "Real &amp; Imaginary" <ul style="list-style-type: none"> <li>• The user selects "Real &amp; Imaginary" and the system auto-returns to the TRACE FORMAT menu.</li> </ul> </li> <li>4. Modified TRACE FORMAT Menu with Impedance setting as "Real &amp; Imaginary" <ul style="list-style-type: none"> <li>• The TRACE FORMAT menu automatically re-appears with impedance set as "Real &amp; Imaginary."</li> </ul> </li> </ol> |
|--|--|

**Figure 4-12.** Auto-Return Button Group Example on the IMPEDANCE Menu

### Completion Checkmark Button

In the **Calibration** menus, some buttons list the required tasks for each calibration type. The completion checkmark icon indicates that a calibration task has been completed.



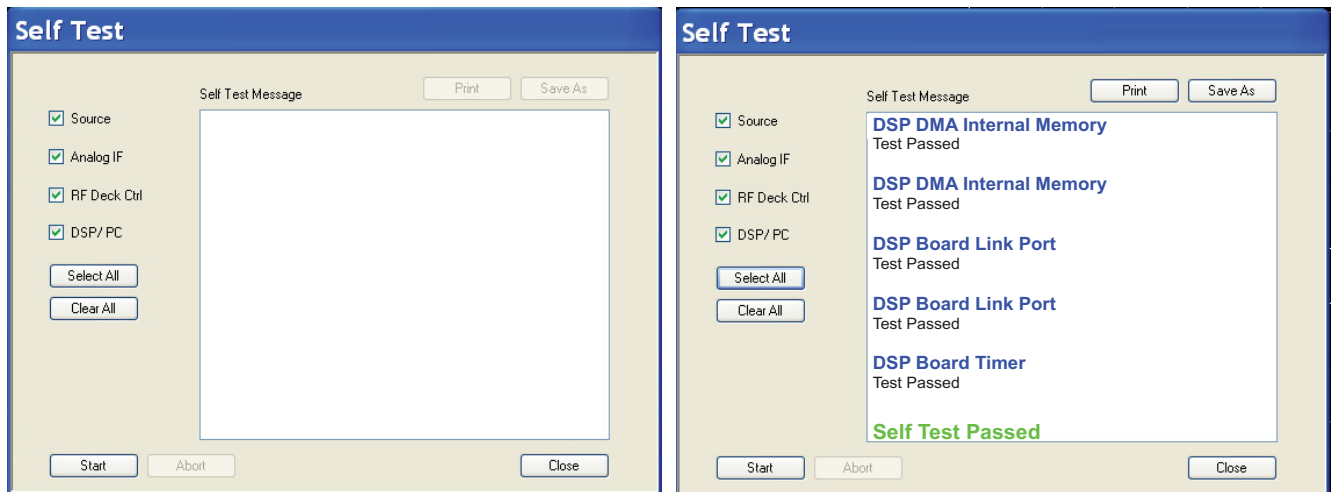
For example, in a Full 2 Port Reflection Calibration, one of the required steps is a Port 1 Short test.



The button above left shows the test has not been started. The user makes the necessary physical connections between the VNA and the required connector/adaptor, and then clicks the button to begin the test. The button dims while the test is performed. After the test is successfully completed, the completion icon appears on the left side of the button as shown above right.

## 4-8 Using Dialog Boxes

Most dialog boxes are standard Microsoft dialog boxes and appear in the center of the display area.



①

②

1. SELF TEST dialog prior to starting tests (at left).

2. SELF TEST dialog box after tests with result of Self Test Passed (at right).

**Figure 4-13.** Dialog Box Example

### Standard Dialog Box Buttons

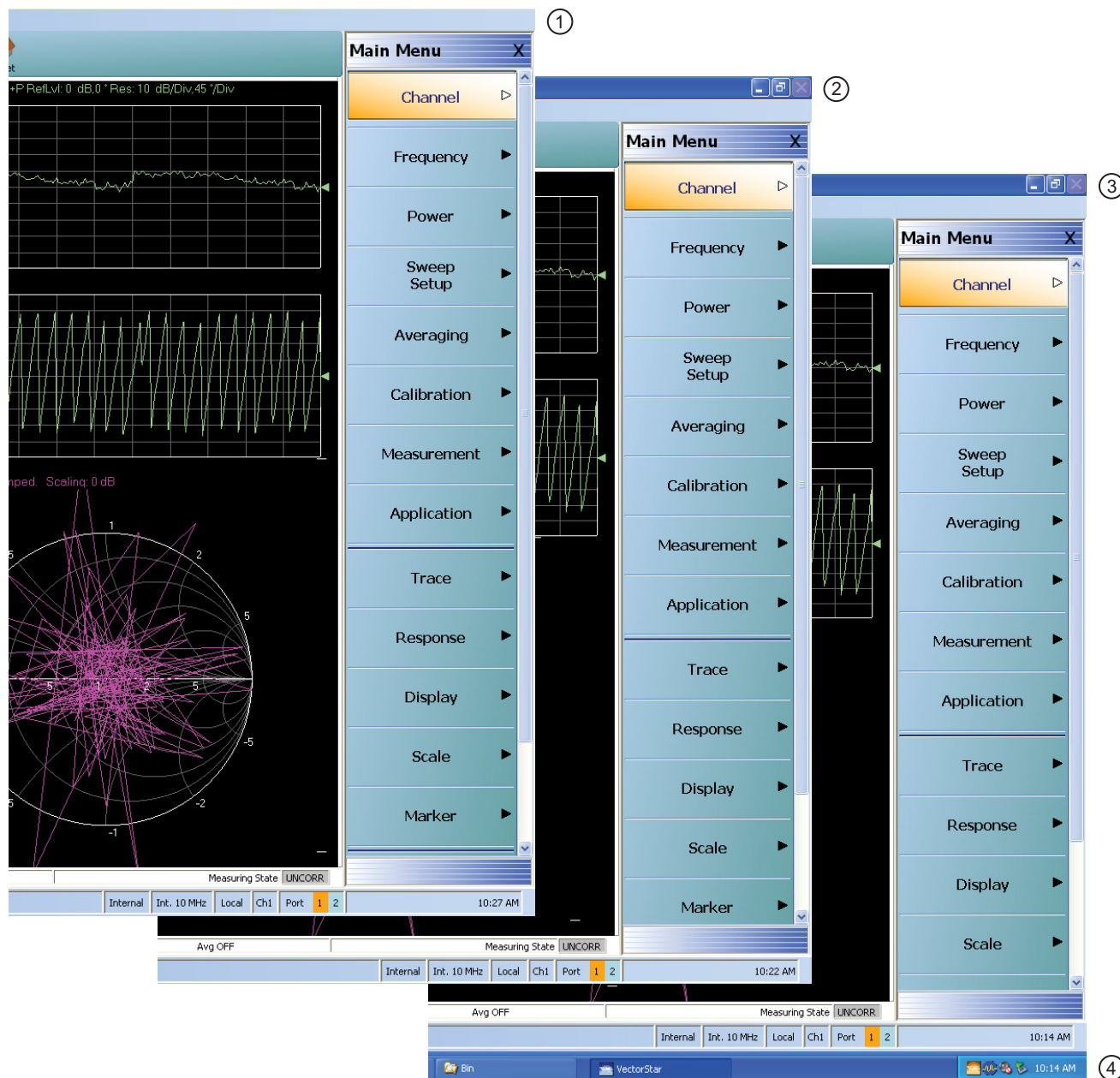
Most dialog boxes also have some combination of standard buttons for OK, Cancel, and Save. Other buttons and types of buttons may be present. Within dialog boxes are **Dialog Box Areas** that are usually named for the options that can be selected or the information that is displayed. For example, in the figure above, test status and completion messages are displayed in the **Self Test Message** area. Most Dialog Box Areas are delimited by a line, box, or shadowbox that contains the information or settings for a series of common attributes. If the area is named in the dialog box, that name is used in any related procedures. If the area is not named, the area is named for the first data or input field. Some dialog boxes have links that call sub-dialog boxes.



## 4-9 Setting the Main Display as Resizable, and/or Task Bar

The default VectorStar Application installation is for the display to be on running on top of all other applications as well as on top of the Windows desktop with the display set to completely fill the screen.

By changing the settings in the VNA setup script, a resizable display and/or a visible task bar can be set as shown in the figure below.



1. At left, standard main display without Resize and Task Bar controls.
2. At center, main display with Resize/Minimize controls.
3. At right top, main display with Resize/Minimize controls.
4. At right bottom, main display with Task Bar displayed.

**Figure 4-14.** Main Display Resize and Task Bar Configuration Options

## Procedure

1. Make sure a keyboard and a mouse are connected to the VNA.
2. Close the VectorStar application.
  - MENU BAR | File | Exit | OK

### Change the Settings for 25,000 Point 16 Channel Configuration

3. Using Windows Explorer, go to “C:\Program Files\Anritsu Company\VectorStar\Bin directory”
  - Launch Windows Explorer by pressing **WINDOWS Key + E** on the keyboard.
4. Locate the file named “AC\_GUIMain.exe.config”.
5. Copy the file and rename the copy as “BACKUP\_AC\_GUIMain.exe.config”.
6. Open “AC\_GUIMain.exe.config” using Windows Notepad or a similar text processor.

### Change the Resize Setting

7. To change the resize setting, search for the “PreventResize” attribute which looks like this.

```
<setting name="PreventResize" serializeAs="String">  
    <value>True</value>  
</setting>
```

8. Change its value from “True” to “False” so that it now looks as follows:

```
<setting name="PreventResize" serializeAs="String">  
    <value>False</value>  
</setting>
```

### Change the Task Bar Setting

9. To change the Task Bar setting, search for the “HideTaskBar” attribute which looks like this.

```
<setting name="HideTaskBar" serializeAs="String">  
    <value>True</value>  
</setting>
```

10. Change its value from “True” to “False” so that it now looks as follows:

```
<setting name="HideTaskBar" serializeAs="String">  
    <value>False</value>  
</setting>
```

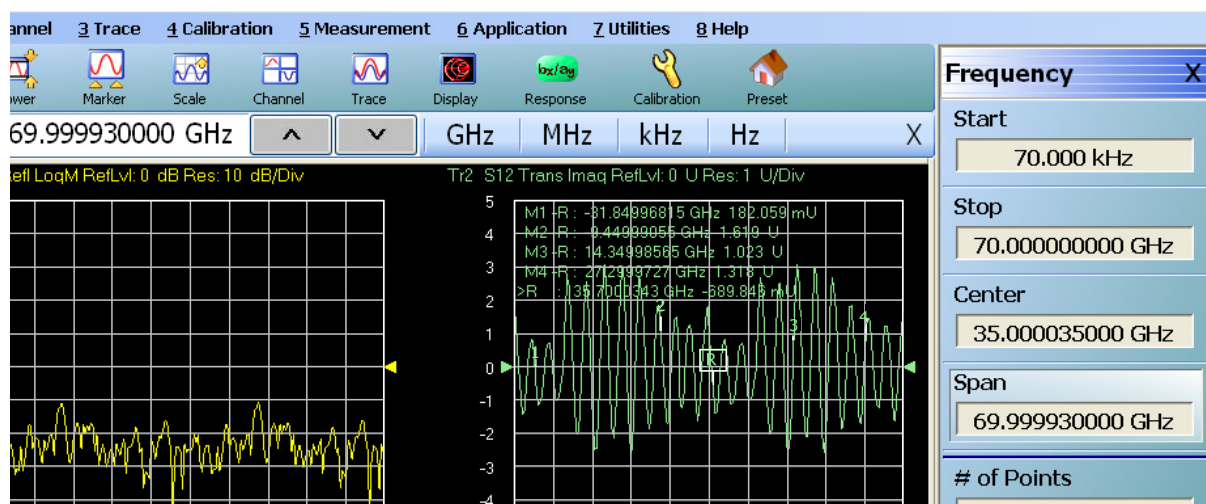
11. Save and close the file.
12. Re-start the VectorStar application.
13. Depending on the changes made above, the VNA Main Display can now be minimized or maximized and/or the Task Bar is now visible.

### Change the Settings for 100,000 Point One Channel Configuration

14. If required, repeat the steps above for the 100,000 point configuration file located at C:\Program Files\Anritsu Company\VectorStar\_100k\Bin. Edit as above the AC\_GUIMain.exe.config file.

## 4-10 Instrument Status Display Area

At the bottom of the instrument display is the status bar where instrument states and conditions are reported.



1. Instrument Status Area.

2. Channel Status Area. If a multichannel display has been set, each channel has a separate status bar. Maximizing the channel display provides readability.

**Figure 4-15.** Typical Instrument Status Display

## Instrument Status Messages

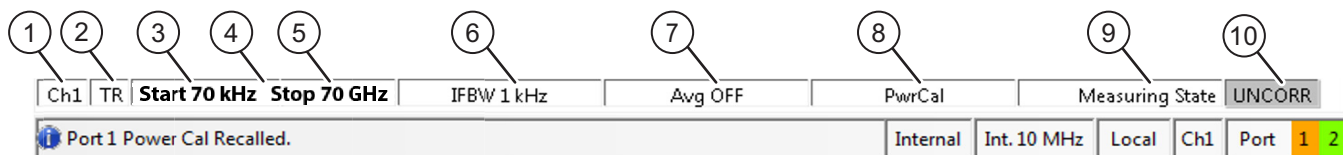
**Table 4-4.** Instrument Status Display Abbreviations

Status Display	Description
Warning Messages	If warning messages occur, they appear on the left side of the Instrument Status Area. For example: <b>Target Value not found for Mkr3.</b>
Internal Manual External GPIB	Defines the status of the system triggering.
Ext. 10 MHz	Indicates that an external 10 MHz reference is in use.
Int. 10 MHz	Indicates that an internal 10 MHz reference is in use.
Local Remote	Local means the instrument is being controlled from its front panel and menu system. Remote means a remote control such as a GPIB controller is in use.
Ch#	Displays the channel number of the active channel. For example, Ch2 means that Channel 2 is selected and active.
Port 1/Port 2/Port 3/Port 4	Highlights the port that is being driven. 2-Port VNAs cycle between Port 1 and 2. 4-Port VNAs cycle between 1 and 4.
Time	Displays the system time.

## 4-11 Channel Status Display Area

At the bottom of each channel display is the channel status bar where the following information (as explained in [Figure 4-16](#) and [Table 4-5](#)) is reported. The displayed parameters are context and setting dependent. Not all parameters are displayed all the time. In a multi-channel display, the display may be truncated. To maximize the channel display, select any of the following:

- Keyboard: **CTRL + 1**
- Keyboard: **ALT + 2 then 6**
- MAIN | Channel | CHANNEL | Chan. Max



**Figure 4-16.** Channel Status Bar

**Table 4-5.** Channel Status Bar Definitions

	Status Display	Description
1	Ch#	Displays the channel number. For example, Ch2 means that the display is for Channel 2.
2	TR	Displays the measurement mode as transmission/reflection.
3	[Start] Start # Units	In general, the left-side parameters define the starting position of distance, frequency, time, or power. From the FREQUENCY menu, if CW Mode is set to off, displays the current Start Frequency value with units of kHz, MHz, or GHz.
4	CW Frequency # Units	From the FREQUENCY menu, if CW Mode is set to on, displays the current CW Frequency value with units of kHz, MHz, or GHz.
5	[End] Stop # Units	In general, the right-side parameters define the ending position of distance, frequency, time, or power. From the FREQUENCY menu, if CW Mode is set to off, displays the current Stop Frequency value with units of kHz, MHz, or GHz.
6	IFBW	From the AVERAGING menu, reports the IF Bandwidth Frequency setting with units of Hz, kHz, or MHz.
7	Avg OFF Avg # # / #	From the AVERAGING menu, reports that Averaging is off, or if values are present, Averaging is on. If Averaging is on, and the Averaging Type is Per-Point, reports the Averaging factor. If Averaging is on, and the Averaging Type is Per-Sweep, the left-side number reports the number of average sweeps; the right-side number displays the Averaging Factor.
8	PwrCal	Power Cal indicator appears if a power cal is applied for any port in the channel.
9	Measuring State Calibrating State	Indicates whether the instrument is measuring or being calibrated.
10	UNCORR CORR EDE E/O	UNCORR (with a dark gray background) indicates that a calibration is not being applied. CORR (with a green background) indicates that the calibration for the active channel is being applied (corrected). EDE (with green background) Indicates Embedding or De-embedding is being applied. E/O, O/E, or O/O (with a green background) indicates an optical measurement state.

## 4-12 Working with the Number of Points

The VectorStar MS464xB Series VNA can be set to either 25,000 or 100,000 total measurement points through the user interface. If the total points setting is changed, the instrument must be restarted.

### Maximum Points Set to 25,000

If 25,000 points is selected, the instrument can have:

- Up to 16 channels.
- Each channel can have up to 16 trace displays.
- Each trace display can have up to 12 regular markers and 1 reference marker.
- The total instrument measurement points are limited to a total of 25,000 points in any combination between channels and trace displays/

### Maximum Points Set to 100,000

If 100,000 points is selected, the instrument can have:

- Only 1 (one) channel.
- The single channel can have up to 16 trace displays.
- Each trace display can have up to 12 regular markers and one reference marker.
- The total instrument measurement points is limited to a total of 100,000 points in any combination between the 16 trace displays/

### To Change the Number of Points

1. Be sure the instrument is not connected to a test setup and can be restarted.
2. Navigate to the change menu:
  - MAIN | System | SYSTEM | Setup | SETUP | Max Points Setup | MAX POINTS
  - The MAX POINTS menu appears.
3. Select either the 25000 or 100000 points button.
  - If 25,000 points are selected, the system can have up to 16 channels, each with up to 16 trace graph displays. The 25,000 points can be allocated between the channels and traces in any combination.
  - If 100,000 points are selected, the system can have 1 (one) channel with up to 16 trace graph displays. The 100,000 points can be allocated between the 16 traces in any combination.
4. After the selection is made, click **Back** or **Home**.
5. Then exit VectorStar and reboot the instrument to activate the new points setting.

## 4-13 Working with Channels

Each VNA channel is like a separate VNA, with its own frequency list, calibrations, power setup and other parameters. Each channel can display up to 16 individual trace graph displays.

The number of VNA channels is user-definable, subject to the limits of the Maximum Point Mode of the instrument described in the section above.

### 25,000 Point Mode

If the instrument is set to the 25,000 point mode, up to 16 channels, each with up to 16 traces can be defined for a total of 256 traces. The number of sweep points can be distributed to the defined channels and traces in any combination. The screen layout of the VNA channels is also user-definable by selecting from multiple pre-defined layouts. If many channels and trace graphs are used, the user can quickly maximize any channel and/or trace display for ease of viewing and closer inspection.

### 100,000 Point Mode

If the instrument is set to 100,000 point mode, the instrument is limited to 1 channel with 16 traces. The 100,000 sweep points can be distributed across the defined traces in any combination. On the MENU BAR, the CHANNEL drop-down menu is limited to four choices: Frequency, Power, Sweep, and Averaging. On the right-side menus, the CHANNEL menu buttons are unavailable.



### Channel Detach

Channel detach creates a new window containing the graph area of the active channel. This can be useful with external monitor configurations where one wishes to examine a given channel's data in more detail without maximizing the channel.

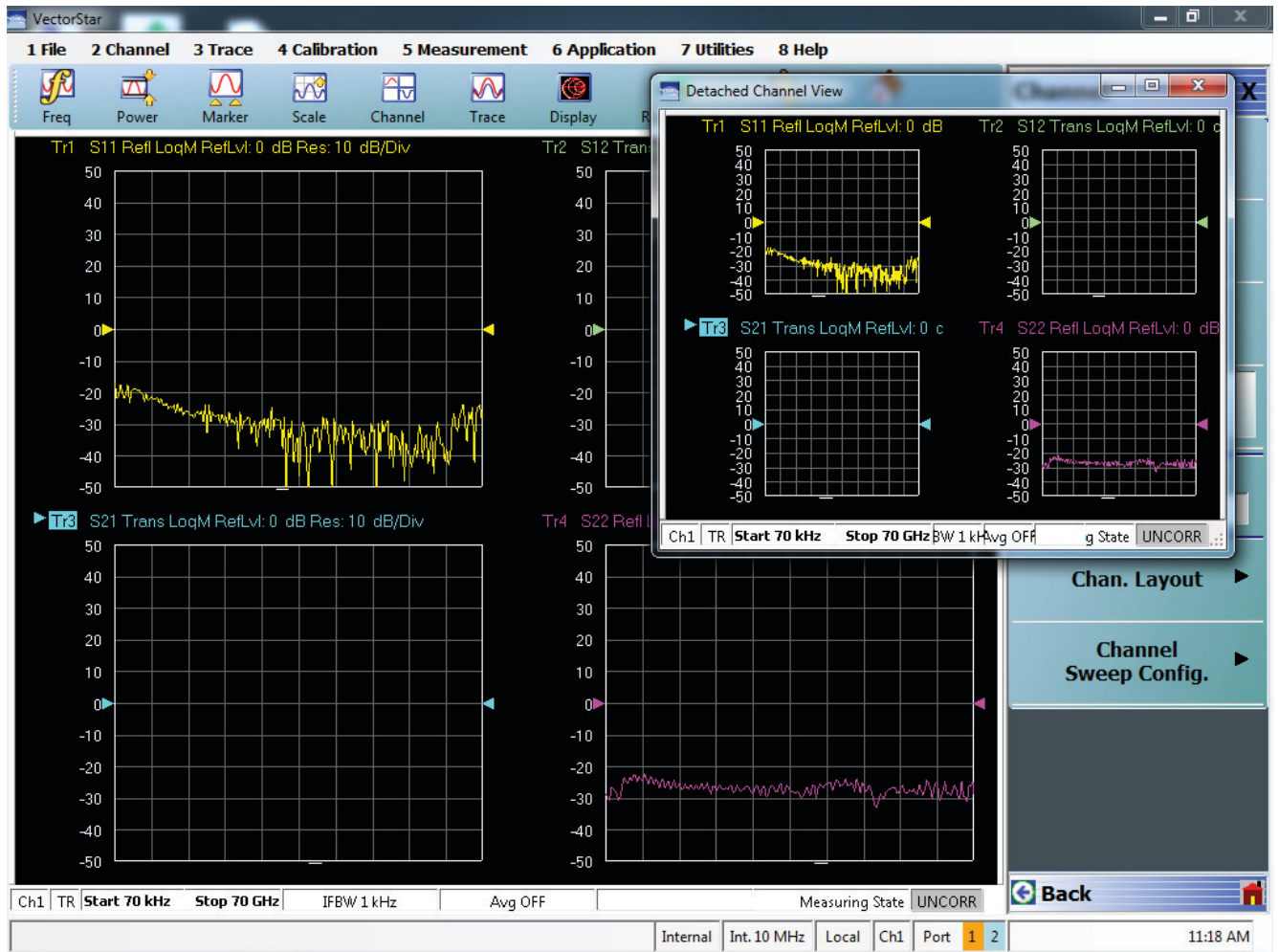


Figure 4-17. Detached Channel Display

## Channel Sweep Control

Several tools are available to control which channels are sweeping. By default, each channel sweeps sequentially in order of channel number. If there are many sweep points or a low IF bandwidth in one or more channels, it can take a long time for a given channel to sweep and the data to update. One can sweep only the active channel using a menu toggle. One can also independently select which channels are sweeping using the CHANNEL SWEEP CONFIGURATION dialog shown below.

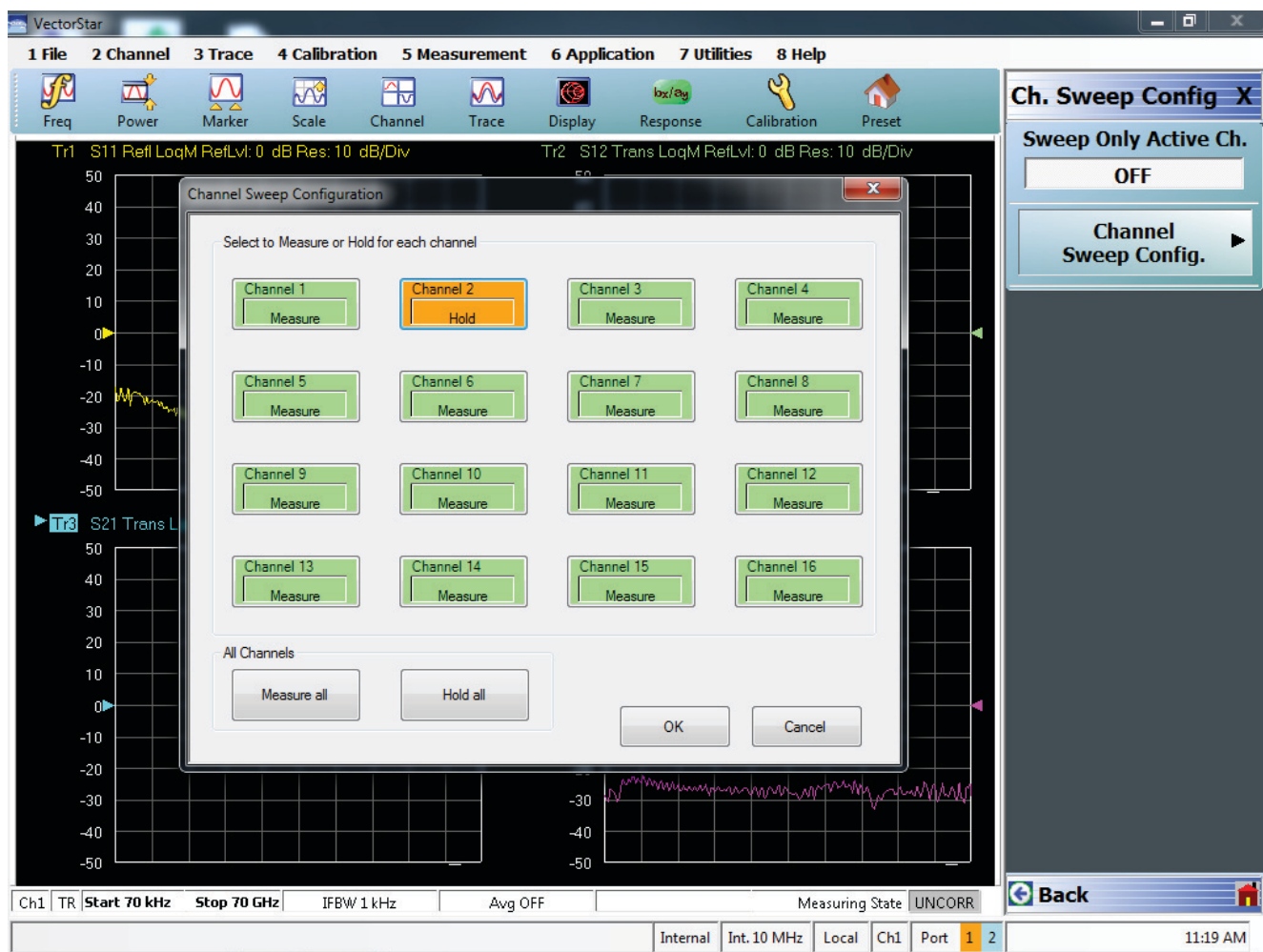


Figure 4-18. Channel Sweep Control Dialog Box

## 4-14 Working with Traces

### Types of Trace Displays

For each channel defined above, from 1 (one) to 16 trace graphs (called “traces”) can be defined where each trace is a data display within a specific channel. Each trace is defined by a response parameter (such as S11), a graph type display (such as a rectilinear graph, a polar display or Smith chart), a scale, and possibly post-processing elements such as time domain and smoothing. There are four general graph types available and within each general type are multiple sub-types:

- Rectilinear single graph
- Rectilinear dual graph
- Polar plot graph
- Smith chart

### Trace Data Types

The data types generated by the VNA (real, imaginary, magnitude, phase) are used in the display graph to show the possible ways in which S-Parameter data can be represented. For example, complex data, that is data in which both phase and magnitude are graphed, may be displayed in any of the following ways:

- **Complex Impedance**  
Displayed on a Smith chart graph as impedance or as admittance
- **Real and Imaginary**  
If simultaneous displays are required, displayed on a real and imaginary rectilinear (a Cartesian plot) graph. If only one type is required, a single rectilinear real graph or single rectilinear imaginary graph.
- **Phase and Magnitude**  
Displayed on a single rectilinear graph, as paired rectilinear graphs, or as a polar graph
- **Group Delay**  
Defined as the frequency span over which the phase change is computed at a given frequency point. The quantity group delay is displayed using a modified rectilinear-magnitude format. In this format, the vertical scale is in linear units of time (either ps, ns, us, or ms). With one exception, the reference value and reference line functions operate the same as they do with a normal magnitude display.

### Trace Display Graphs

A separate graph can be assigned to each active channel and display area. The following available display graph types are listed in [Table 4-6](#) below.

**Table 4-6.** Available Trace Display Types (1 of 4)

Menu Name	Definition and Display Options	Y-Axis Dependent Variable	X-Axis Independent Variable	Measurement Applications
<b>Rectilinear Single Graphs</b>				
<b>Log Mag</b>	Log magnitude rectilinear format graph Magnitude		Y = dB	Return loss measurement Insertion loss measurement Gain measurement

Table 4-6. Available Trace Display Types (2 of 4)

Menu Name	Definition and Display Options	Y-Axis Dependent Variable	X-Axis Independent Variable	Measurement Applications
<b>Linear Mag</b>	Linear magnitude rectilinear format graph	Magnitude	Linear units	Reflection coefficient measurement
<b>Phase</b>	Phase rectilinear format graph	Phase displayed in range from -180 to + 180 degrees	Degrees	Linear phase deviation measurements
<b>Imaginary</b>	Imaginary rectilinear format graph	Imaginary part of measured complex parameter	Linear units	
<b>Real</b>	Real rectilinear format graph	Real part of measured complex parameter	Linear units	
<b>SWR</b>	Standing Wave Ratio rectilinear format graph	$SWR = \frac{1 + \rho}{1 - \rho}$ where $\rho$ = Reflection Coefficient	Linear units	Standing wave measurements Antenna analysis
<b>Impedance</b>	Impedance rectilinear format graph  Six options are: <ul style="list-style-type: none"> <li>• Real</li> <li>• Imaginary</li> <li>• Magnitude</li> <li>• Real &amp; Imaginary</li> <li>• Inductance</li> <li>• Capacitance</li> </ul>			
<b>Polar Graphs</b>				
<b>Linear Polar</b>	Linear polar plot graph  The polar graph format traces are used to display one magnitude value and phase on the same chart.  Plot options: <ul style="list-style-type: none"> <li>• Lin/Phase</li> <li>• Real/Imag.</li> </ul>		Chart mode options: <ul style="list-style-type: none"> <li>• Magnitude/Phase</li> <li>• Magnitude/Swap Position</li> </ul>	
<b>Log Polar</b>	Plot options: <ul style="list-style-type: none"> <li>• Log/Phase</li> <li>• Real/Imag.</li> </ul>		Chart mode options: <ul style="list-style-type: none"> <li>• Magnitude/Phase</li> <li>• Magnitude/Swap Position</li> </ul>	

Table 4-6. Available Trace Display Types (3 of 4)

Menu Name	Definition and Display Options	Y-Axis Dependent Variable	X-Axis Independent Variable	Measurement Applications
<b>Smith Chart Graphs</b>				
<b>Smith (R + jX)</b>	Smith Chart graphs with impedance (circuit resistance and reactance) Five read out style options are available: <ul style="list-style-type: none"> <li>• Lin/Phase</li> <li>• Log/Phase</li> <li>• Real/Imag</li> <li>• Impedance</li> <li>• Impedance L/C</li> </ul>		The impedance is the measure of a circuit's opposition to alternating current which consists of the circuit resistance and the circuit reactance, together they determine the magnitude and phase of the impedance.	<ul style="list-style-type: none"> <li>• Reflection measurements</li> </ul>
<b>Smith (G + jB)</b>	Smith Chart graphs showing admittance (conductance and susceptance). Five read out style options are available: <ul style="list-style-type: none"> <li>• Lin/Phase</li> <li>• Log/Phase</li> <li>• Real/Imag.</li> <li>• Admittance</li> <li>• Admittance L/C</li> </ul>		The admittance (Y) is the inverse of the impedance (Z) and is a measure of how easily a circuit will allow current to flow, a combination of conductance (the inverse of resistance) and the dynamic susceptance (the inverse of reactance).	
<b>Rectilinear Paired Graphs</b>				
<b>Log Magnitude and Phase</b>	Paired graphs with Log Magnitude on top and Phase on bottom	As above	As above	Same as having one trace with a Log Magnitude display and a second trace with a Phase rectilinear display.
<b>Linear Magnitude and Phase</b>	Paired graphs with Linear Magnitude on top and Phase on bottom	As above	As above	Same as having one trace with a Linear Magnitude display and a second trace with a Phase rectilinear display.
<b>Real and Imaginary</b>	Paired graphs with Real on top and Imaginary on bottom	As above	As above	Same as having one trace with a Real rectilinear display and a second trace with an Imaginary rectilinear display.
<b>Group Delay / Power Graphs</b>				

**Table 4-6.** Available Trace Display Types (4 of 4)

<b>Menu Name</b>	<b>Definition and Display Options</b>	<b>Y-Axis Dependent Variable</b>	<b>X-Axis Independent Variable</b>	<b>Measurement Applications</b>
<b>Group Delay</b>	Displays the time lag through a DUT measured in ps, ns, us, or ms.	Time measured in ps, ns, us, or ms.	Frequency	Bandpass filter design Transmission studies
<b>Power In</b>	Displays power in measurement through a DUT measured in dBm.	Absolute power measured in dBm.	Frequency	Efficiency Receiver calibration Power consumption Power and heat dissipation
<b>Power Out</b>	Displays power out measurement through a DUT measured in dBm.	Absolute power measured in dBm.	Frequency	Efficiency Receiver calibration Power consumption Power and heat dissipation

Each graph type is described in greater detail below with sample graphs, and explanation of supporting trace displays.

## Trace Labels

Each trace (i.e. each graph display) is labeled with information such as its trace number, the graph type, scaling, reference delay, and S-parameter associated with that trace. Depending on the trace settings and the graph type, other information may be displayed.

The general format of trace label consists of the following parameters and their associated abbreviations appearing from left to right in the trace label. Some parameters may not appear depending on the instrument settings.

- Trace Number
- Trace Memory Statistics
- Inter-Trace Math Factor
- Measurement Type
- Graph Type
- Reference Level
- Resolution Units
- Conversion Factor
- Time Domain

Trace labels can be customized by the user in the DISPLAY SETUP menu and toggled on or off as an alternate trace name.

- MAIN | Display | DISPLAY | Display Area Setup | DISPLAY SETUP | Edit Alternative Trace Name | EDIT ALTERNATE TRACE NAME dialog box



## Trace Label Abbreviations

The trace label abbreviations are described in the three tables below:

- [Table 4-7, “Trace Labels - Trace Number, Measurement Type](#)
- [Table 4-8, “Trace Labels - Abbreviation, Type and Name, Reference Level Units, Resolution Units](#)
- [Table 4-9, “Trace Labels - Conversion, Inter-Trace Math, Trace Memory Abbreviations](#)

**Table 4-7.** Trace Labels - Trace Number, Measurement Type (1 of 2)

Abbreviation	Definition	Description
<b>Trace Number Abbreviation</b>		
<b>Tr# / SPA#</b>	Trace number	Trace 1 through Trace 16. Note: When in the Spectrum Analysis application Tr#-->SPA#.
<b>Measurement Type Abbreviations</b>		
<b>S11 Refl</b>	S11 Port 1 forward reflection	S-parameters are selected on the RESPONSE menu.
<b>S12 Trans</b>	S12 Port 1 reverse transmission	
<b>S21 Trans</b>	S21 Port 2 forward transmission	
<b>S22 Refl</b>	S22 Port 2 reverse reflection	
<b>IM(n)</b>	The IMD product in dBc terms	Product level relative to the main tone level. n = the product order (can be 2,3,5,7 or 9)
<b>OIP(n)</b>	Output Referred Nth order Intercept point	Calculated intersection of the main tone power and product power based on the measurement at one power level. n= the product order (can be 2,3,5,7 or 9)
<b>Pwr(n)</b>	Power of IMD main tone or N <sup>th</sup> order IMD products	Tone power: represents the absolute power of a main tone (n=1) or of a product (n = 2,3,5,7, or 9)
<b>Asym(n)</b>	IMD Asymmetry	Difference between upper and lower amplitudes of a given order (including order 1 for main tones). n = the tone or product order (can be 1,2,3,5,7 or 9)
<b>b1/1/Pm or b2/1/Pm</b>		When in ordinary multiple source (not an IMD mode), a power sweep of an IMD main tone or of a product can be orchestrated. The displayed response is a standard unratiod wave variable (usually b1/1 or b2/1). m = the driving port (can be arbitrary if both sources are driving in an Option 31 equipped system)
<b>[x] Noise Figure</b>	Noise Figure response of [x]	x can denote B1 receiver path, B2 receiver path, Differential mode [Diff] or Common mode [Comm]
<b>[x] Noise Temperature</b>	Noise Temperature of [x]	x can denote B1 receiver path, B2 receiver path, Differential mode [Diff] or Common mode [Comm]
<b>[x] Noise Power</b>	Noise Power of [x]	x can denote B1 receiver path, B2 receiver path, Differential mode [Diff] or Common mode [Comm]
<b>[x] Available Gain</b>	Available Gain of DUT if output saw conjugate match, based on loaded S-parameters (in Noise Figure application)	x can denote B1 receiver path, B2 receiver path, Differential mode [Diff] or Common mode [Comm]

Table 4-7. Trace Labels - Trace Number, Measurement Type (2 of 2)

Abbreviation	Definition	Description
<b>[x] Insertion Gain</b>	Insertion Gain of DUT, based on loaded S-parameters (in Noise Figure application)	x can denote B1 receiver path, B2 receiver path, Differential mode [Diff] or Common mode [Comm]
<b>Gain Compression</b>		
--	If Gain Compression is off, the @CP trace label does not appear after the Measurement Type.	For example, Tr3 S21 Trans LogM
@CP	If Gain Compression is on, the @CP (at Compression Point) appears after the Measurement Type.	For example, Tr3 S21@CP Trans LogM
<b>NN / DD   Port #</b>	NN is user-defined numerator value. DD is user-defined denominator value. Port number	User-defined numerator, denominator, and driver port are selected on the RESPONSE   User-defined   USER-DEFINED menu.  Numerator and denominator options are A1, B1, A2, B2, or 1.  Port number selection options are Port 1 or Port 2.
<b>Ext.In [DC1   P#]</b>	External Analog Input 1 Driver Port number	User-defined External Analog Input 1 port is selected on the RESPONSE   Ext. Analog In 1   EXT. ANALOG IN 1 menu.  Port number selection options are Port 1 or Port 2.
<b>Ext.In [DC2   P#]</b>	External Analog Input 2 Driver Port number	User-defined External Analog Input 2 port is selected on the RESPONSE   Ext. Analog In 2   EXT. ANALOG IN 2 menu.  Port number selection options are Port 1 or Port 2.

## Rectilinear Single Graph

**Table 4-8.** Trace Labels - Abbreviation, Type and Name, Reference Level Units, Resolution Units (1 of 2)

Graph Abbreviation	Graph Name and Type	Reference Level (RefLvl)	Resolution Units (Res)
<b>Rectilinear Single Graph</b>			
<b>LogM</b>	Log Mag (Log Magnitude) rectilinear	dB	dB/Div
<b>LinM</b>	Linear Mag (Linear Magnitude) rectilinear	U	U/Div
<b>Phase</b>	Phase rectilinear with units in degrees (°)	°	°/Div
<b>Real</b>	Real rectilinear	U	U/Div
<b>Imag</b>	Imaginary rectilinear	U	U/Div
<b>SWR</b>	SWR rectilinear	U	U/Div
<b>Imped Real</b>	Impedance Real rectilinear with units in Ohms ( $\Omega$ )	$\Omega$	$\Omega$ /Div
<b>Imped Imag</b>	Impedance Imaginary rectilinear	$\Omega$	$\Omega$ /Div
<b>Imped Mag</b>	Impedance Magnitude rectilinear	$\Omega$	$\Omega$ /Div
<b>Imped R + I</b>	Impedance Real and Imaginary rectilinear. A rectilinear paired graph.	$\Omega$	$\Omega$ /Div
<b>Capacitance</b>	Capacitance rectilinear	F	fF/Div
<b>Inductance</b>	Inductance rectilinear	H	pH/Div
<b>Smith Charts with Impedance or Admittance</b>			
<b>Smith Imped</b>	The display can be one of four possible Smith Chart with impedance displays: <ul style="list-style-type: none"> <li>• Smith (R+jX) Linear/Phase Smith Chart</li> <li>• Smith (R+jX) Log/Phase Smith Chart</li> <li>• Smith (R+jX) Real/Imaginary Smith Chart</li> <li>• Smith (R+jX) Impedance Smith Chart</li> <li>• Smith (R+jX) L/C Smith Chart</li> </ul>	—	U/Div
<b>Smith Admitt</b>	The display can be one of four possible Smith Chart with admittance displays: <ul style="list-style-type: none"> <li>• Smith (G+jB) Linear Phase Smith Chart</li> <li>• Smith (G+jB) Log Phase Smith Chart</li> <li>• Smith (G+jB) Real/Imaginary Smith Chart</li> <li>• Smith (G+jB) Admittance Smith Chart</li> <li>• Smith (G+jB) L/C Smith Chart</li> </ul>	—	U/Div
<b>Polar Graphs</b>			
<b>Lin Pol</b>	Linear Polar, Linear/Phase polar	U	U/Div
<b>Lin Pol, RI</b>	Linear Polar, Real/Imaginary polar	U	U/Div
<b>Log Pol</b>	Log Polar, Log/Phase polar	dB	dB/Div
<b>Log Pol, RI</b>	Log Polar, Real/Imaginary polar	dB	dB/Div

**Table 4-8.** Trace Labels - Abbreviation, Type and Name, Reference Level Units, Resolution Units (2 of 2)

Graph Abbreviation	Graph Name and Type	Reference Level (RefLvl)	Resolution Units (Res)
<b>Rectilinear Paired Graphs</b>			
<b>LogM + P</b>	Log Magnitude and Phase rectilinear paired graphs.	dB, °	dB/Div, °/Div
<b>LinM + P</b>	Linear Magnitude and Phase rectilinear paired graphs	dB, °	dB/Div, °/Div
<b>R + I</b>	Real and Imaginary rectilinear paired graphs	U	U/Div, U/Div
<b>Group Delay and Power Rectilinear Graphs</b>			
<b>Grp Dly</b>	Group Delay rectilinear with units of seconds	s	s/Div
<b>Pwr Out</b>	Power Out rectilinear	dBm	dB/Div
<b>Pwr In</b>	Power In rectilinear	dBm	dB/Div

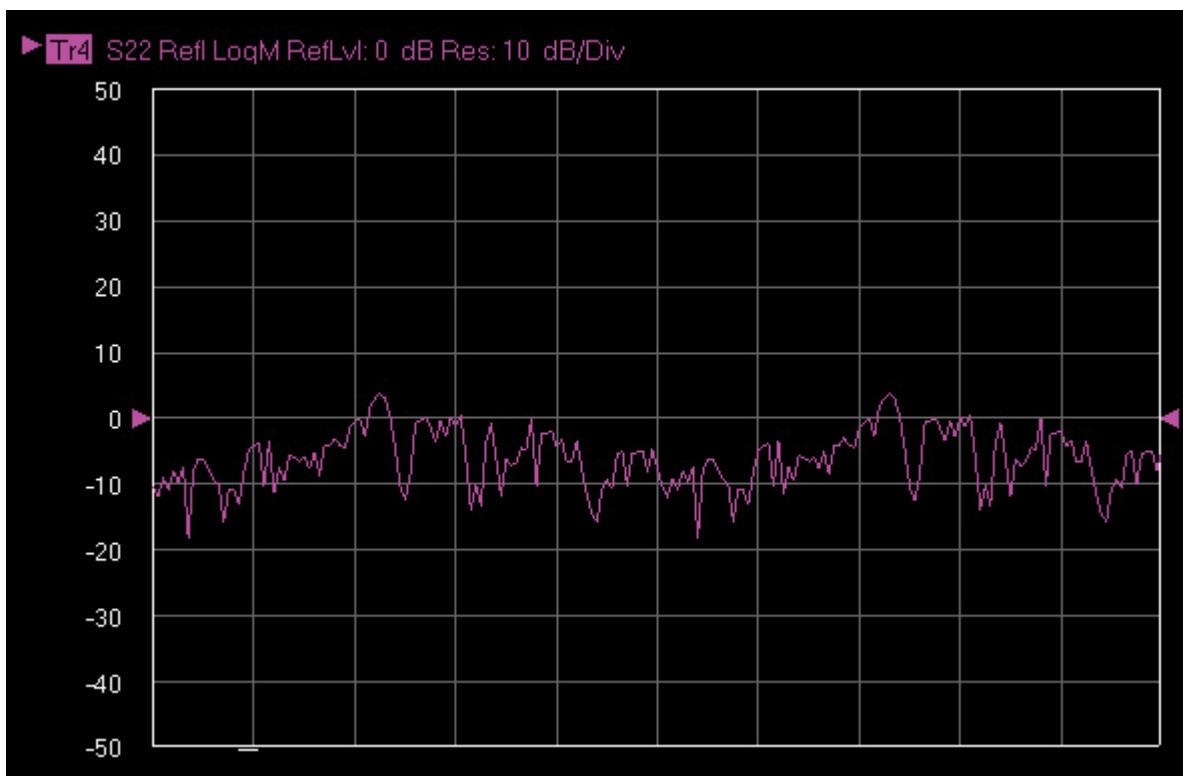
**Table 4-9.** Trace Labels - Conversion, Inter-Trace Math, Trace Memory Abbreviations (1 of 2)

Abbreviation	Definition	Description
<b>Conversion (Con) Abbreviations</b>		
—	If Conversion is off, no abbreviation appears.	
[Con]	If Conversion is on, the conversion factor is appended to the right of the trace annotation.	
[Zr]	Z: Reflection	
[Zt]	Z: Transmission	
[Yr]	Y: Reflection	
[Yt]	Y: Transmission	
[1/S]	1/S	
<b>Inter-Trace Math (ITM) Abbreviations</b>		
—	If Inter-trace math is off, no abbreviation appears.	
[ITM]	If Inter-Trace Math is on, the math factor abbreviation (described below) is appended to the right of the trace annotation.	
[Con, ITM]	If Conversion (above) is on, the Inter-Trace Math abbreviation appears to its right, separated by a comma.	
Tr	Trace number	Inter-trace math can utilize any trace number that is currently defined.
[Tr + Tr]	Inter-trace math addition.	The trace number assigned to Operand 1 plus value of the trace number assigned to Operand 2.

**Table 4-9.** Trace Labels - Conversion, Inter-Trace Math, Trace Memory Abbreviations (2 of 2)

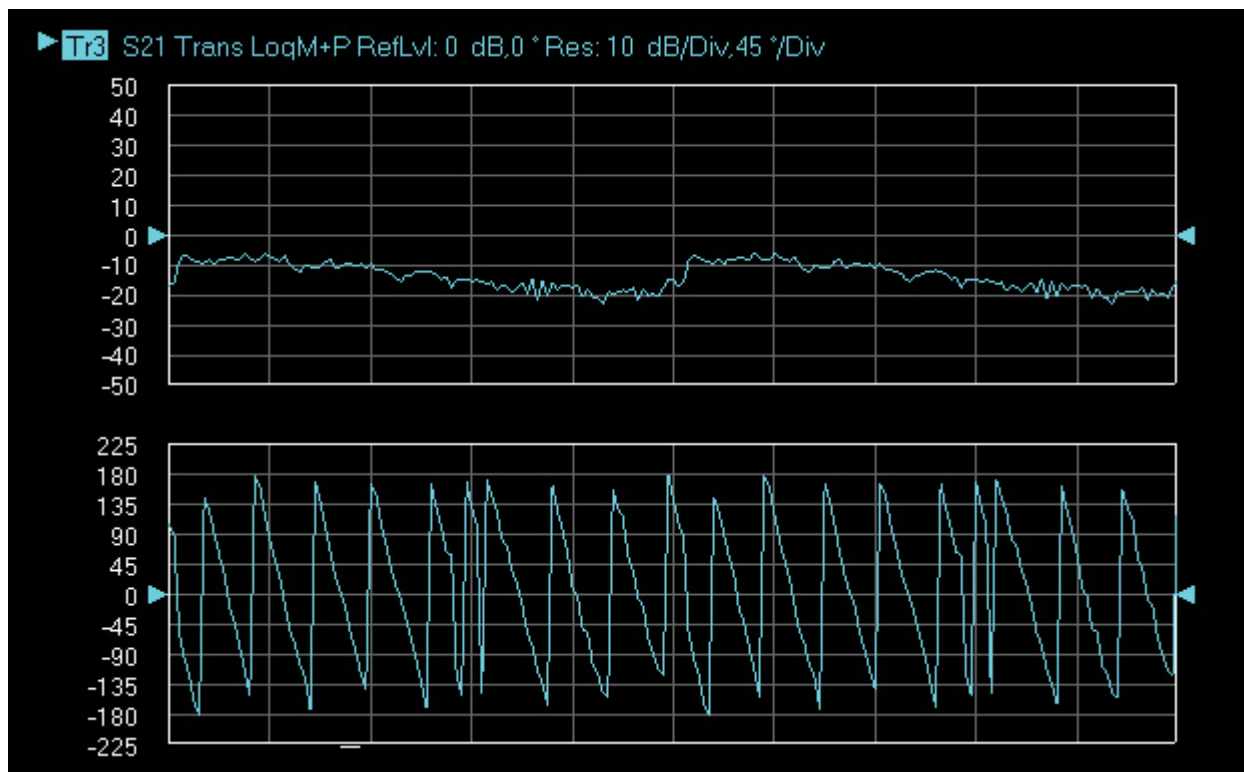
Abbreviation	Definition	Description
[Tr - Tr]	Inter-trace math subtraction.	The trace number assigned to Operand 1 minus value of the trace number assigned to Operand 2.
[Tr * Tr]	Inter-trace math multiplication.	The trace number assigned to Operand 1 times value of the trace number assigned to Operand 2.
[Tr / Tr]	Inter-trace math division.	The trace number assigned to Operand 1 divided by the value of the trace number assigned to Operand 2.
[EQN]	Equation Editor	If using Equation Editor, [EQN] notation will show.

A rectilinear graph is a display of a Cartesian coordinate system or plane consisting of an X-axis and a Y-axis. The X-axis displays the independent variable (such as frequency or time) and the Y-axis displays the dependent value.

**Figure 4-19.** Trace Graph - Rectilinear Single - Log Magnitude (Log Mag) Trace Display Graph

## Rectilinear Paired Graphs

As above, but paired with a phase rectilinear graph below. Useful to save a channel, or provide immediate comparison with a function value and its phase.



**Figure 4-20.** Trace Graph - Rectilinear Paired - Trace Log Magnitude and Phase Trace Display

## Smith Charts

The power reflected from a DUT has both magnitude and phase because the impedance of the device has both a resistive and a reactive term of the form  $r+jx$ . The  $r$  is referred to as the real or resistive term, while the  $x$  is called the imaginary or reactive term. The  $j$ , sometimes denoted as  $i$ , is an imaginary number. It is the square root of  $-1$ . If  $x$  is positive, the impedance is inductive, if  $x$  is negative the impedance is capacitive. The size and polarity of the reactive component  $x$  is important in impedance matching. The best match to a complex impedance is the complex conjugate which means an impedance with the same value of  $r$  and  $x$ , but with  $x$  of opposite polarity. This term is best analyzed using a Smith Chart, which is a plot of  $r$  and  $x$ .

To display all the information on a single S-parameter requires one or two traces, depending upon the desired format. A very common requirement is to view forward reflection on a Smith Chart (one trace) while observing forward transmission.

### Smith Chart with Impedance (Circuit Resistance and Reactance)

The Smith Chart with impedance (Smith R + ex) has four display options:

- Lin/Phase
- Log/Phase
- Real/Imag.
- Impedance
- Impedance L/C

The impedance is the measure of a circuit's opposition to alternating current which consists of the circuit resistance and the circuit reactance, together they determine the magnitude and phase of the impedance.

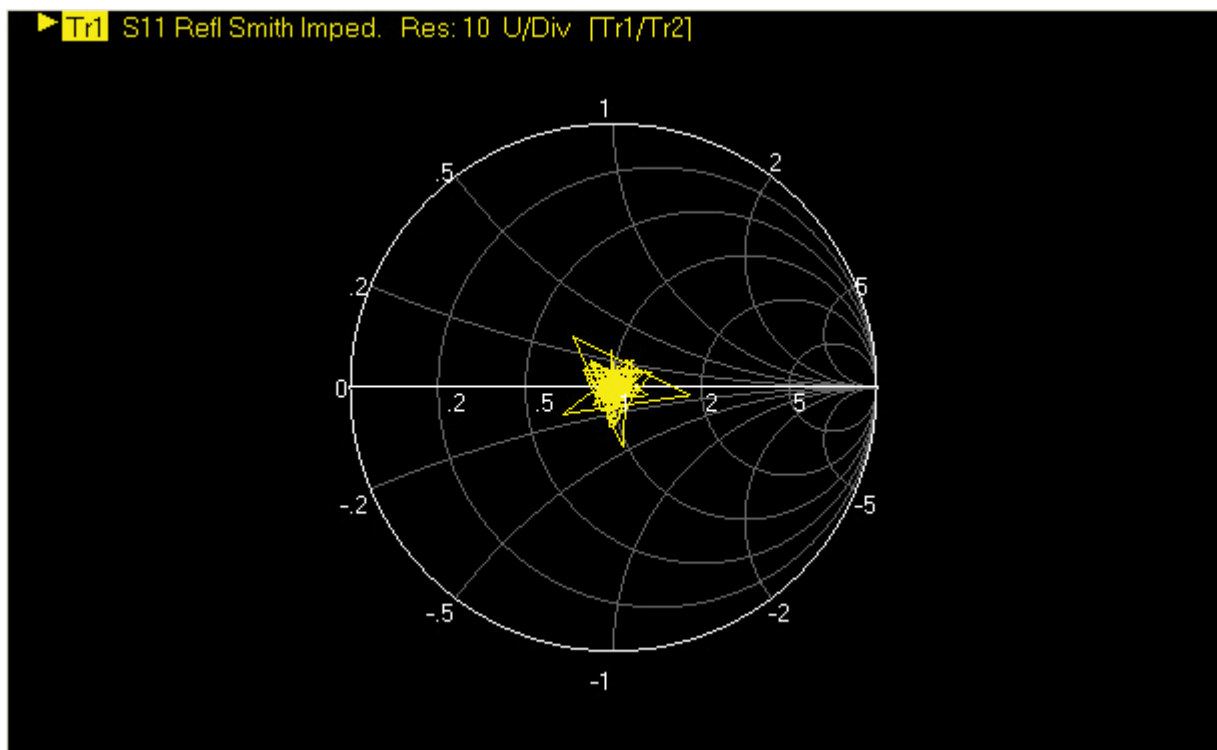


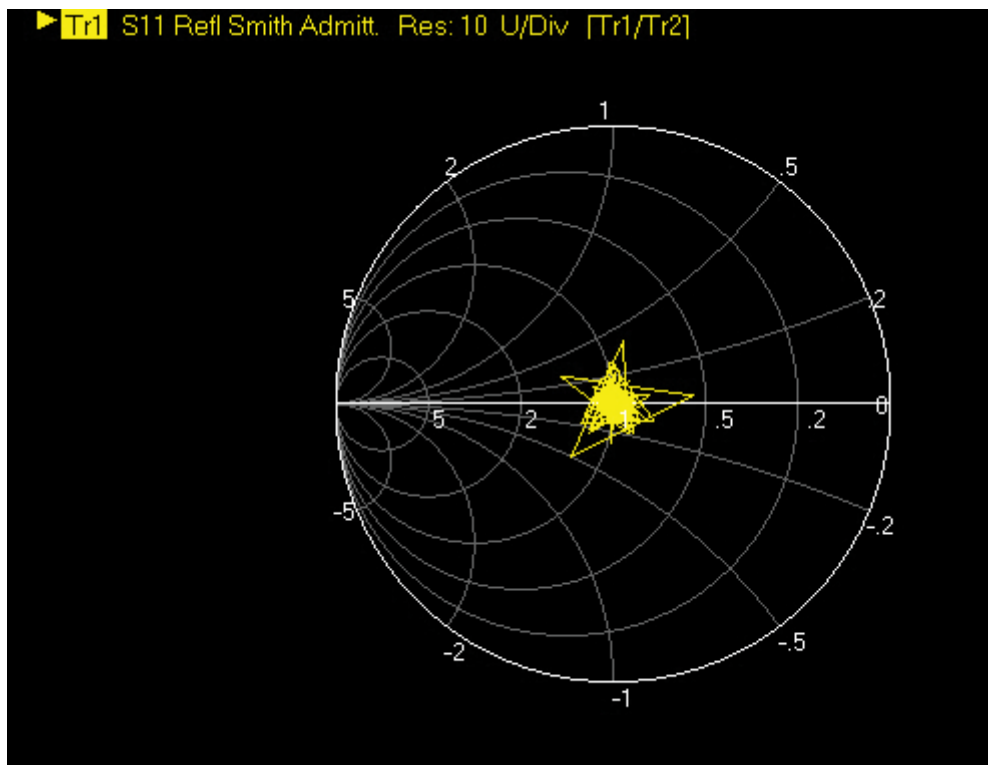
Figure 4-21. Smith Chart with Impedance (R+jX)



### Smith Chart with Admittance (Conductance and Susceptance)

The admittance ( $Y$ ) is the inverse of the impedance ( $Z$ ) and is a measure of how easily a circuit will allow current to flow, a combination of conductance (the inverse of resistance) and the dynamic susceptance (the inverse of reactance). Smith Chart graph display showing admittance (conductance and susceptance) has four read out style options are available:

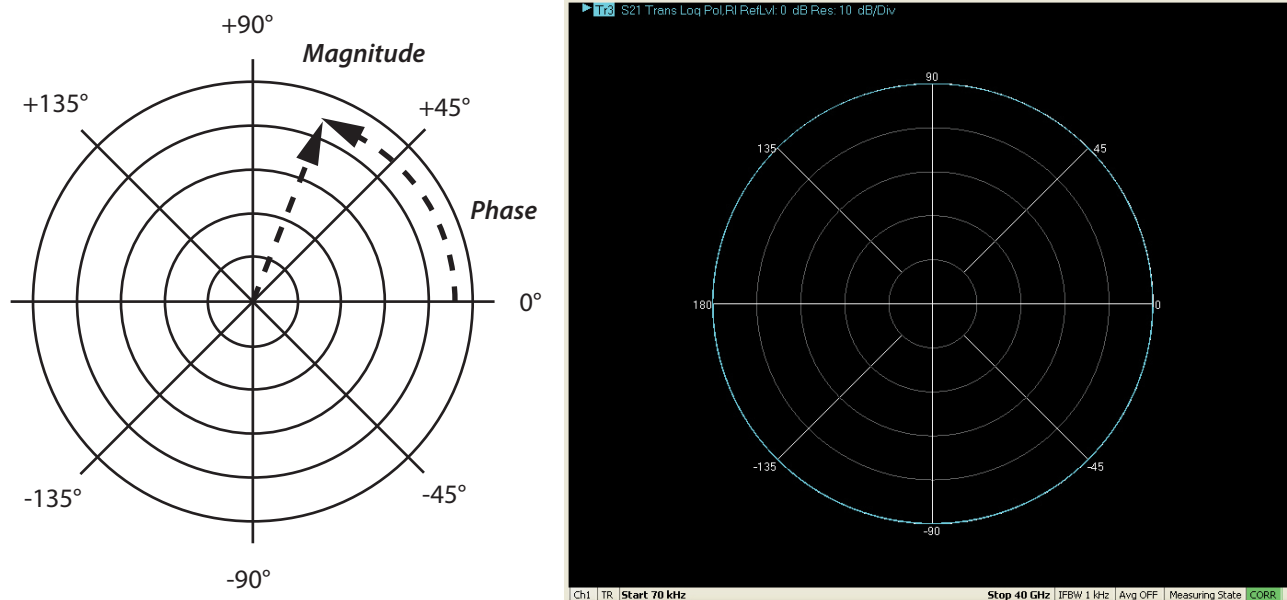
- Lin/Phase
- Log/Phase
- Real/Imag
- Admittance
- Admittance L/C



**Figure 4-22.** Smith Chart with Admittance ( $G+jB$ )

## Polar Graphs

A polar graph represents a two-dimensional coordinate system where each point is determined by an angle and a distance. The polar coordinate system is especially useful in situations where the relationship between two points is most easily expressed in terms of angles and distance such as in phase relationships in antenna and feedline design. The magnitude parameter can use either a linear or log scale. As the coordinate system is two-dimensional, each point is determined by two polar coordinates: the radial coordinate (distance from the center) and the angular coordinate (degrees counterclockwise from the right edge). Polar displays are used for transmission measurements, especially for cascaded devices in series. The transmission result is the addition of the phase and log magnitude (dB) information in the polar display of each device.



**Figure 4-23.** Log Polar Diagram and Trace Graph Example

## Group Delay Graphs

The quantity group delay is displayed using a modified rectilinear-magnitude format. In this format the vertical scale is in linear units of time (ps, ns, us, ms). With one exception, the reference value and reference line functions operate the same as they do with a normal magnitude display. The exception is that they appear in units of time instead of magnitude.

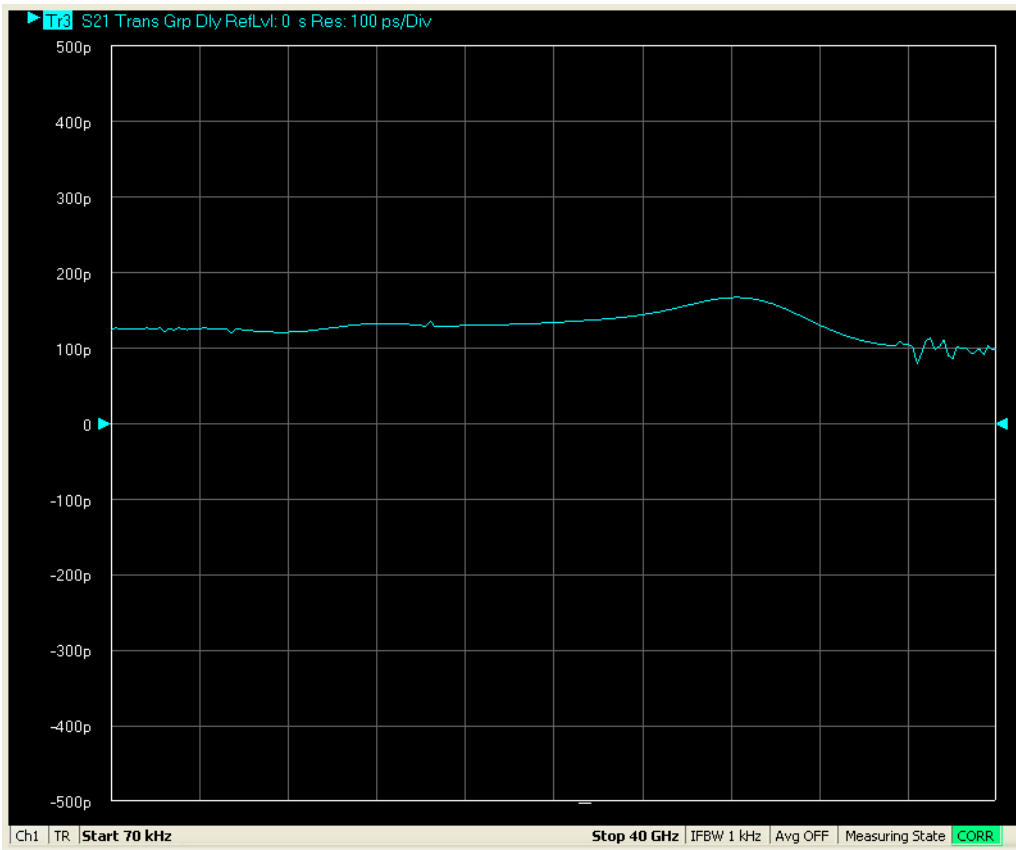
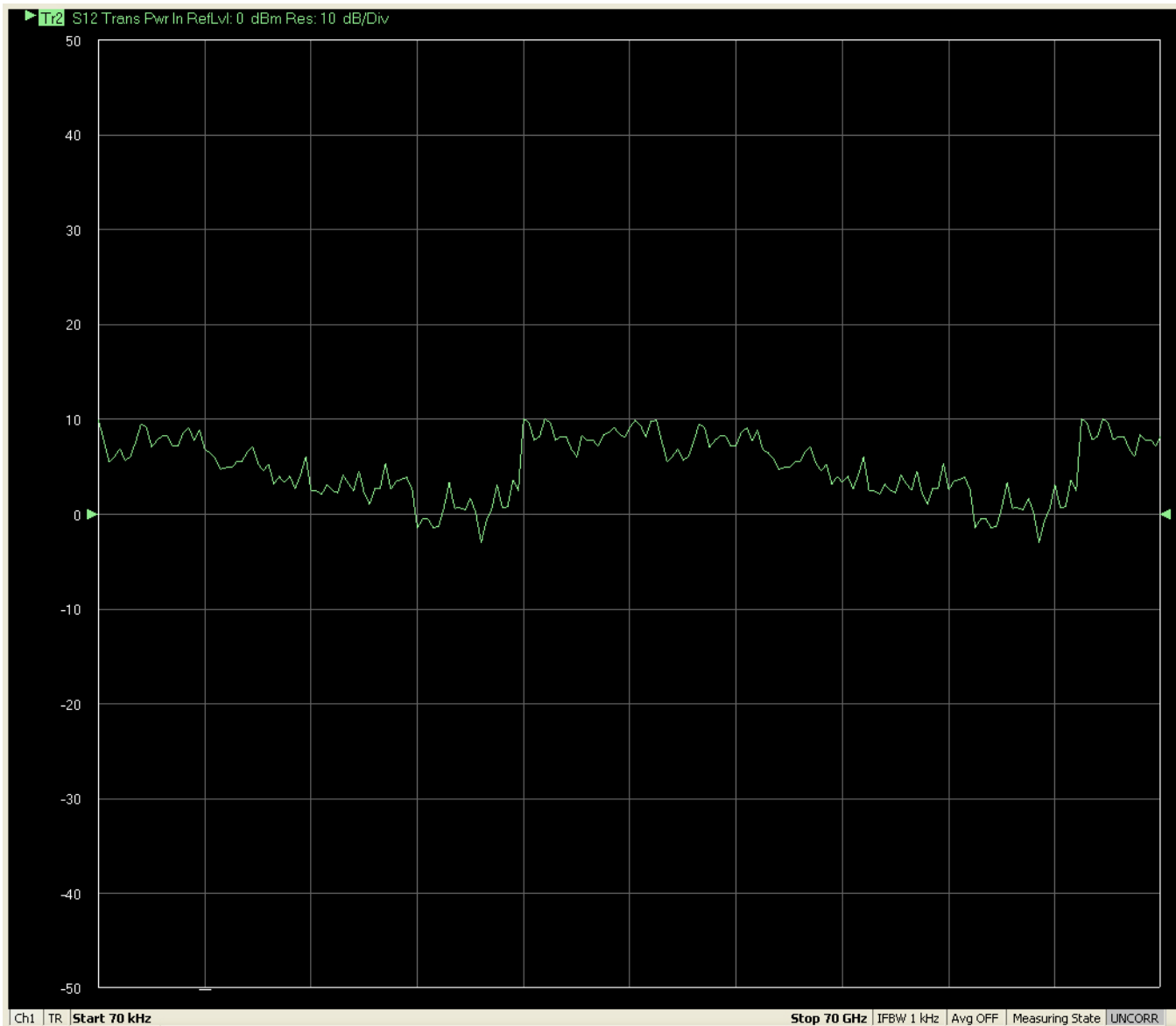


Figure 4-24. Group Delay Trace Graph Example

## Power Graphs



**Figure 4-25.** Power In Trace Graph Example

### Trace Management

The Trace Management dialog box can be used to control the visibility of a trace on the UI. Individual traces can be set to 'Display' or can be turned 'Off'.

Traces can be left uncoupled or can be assigned to one of two coupled groups (A and B). Within a coupled group, the graph types and scales are forced to be the same. If a new member is added to a group, it is coerced to the format of the others in the group, and changing format of any member of the group will change the format of all members of the group.

The grouping process facilitates dual-Y-axis displays when multiple traces are overlaid. If members of A and B groups are overlaid and a member of either group is the active trace, both Y-axes will be displayed (with A and B annotations). If an uncoupled trace is active in such an overlay situation, only the Y-axis for that trace will be visible.

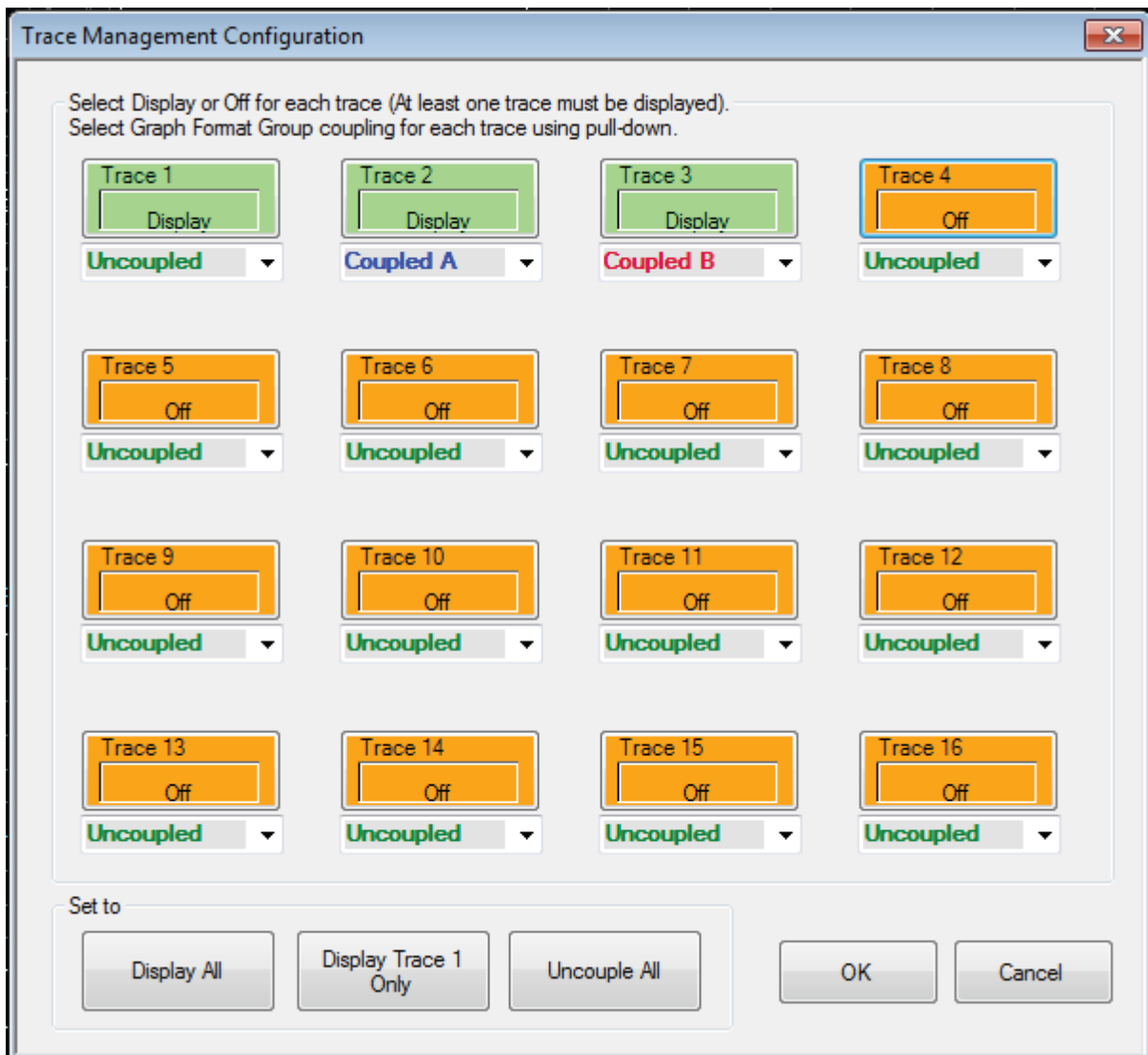
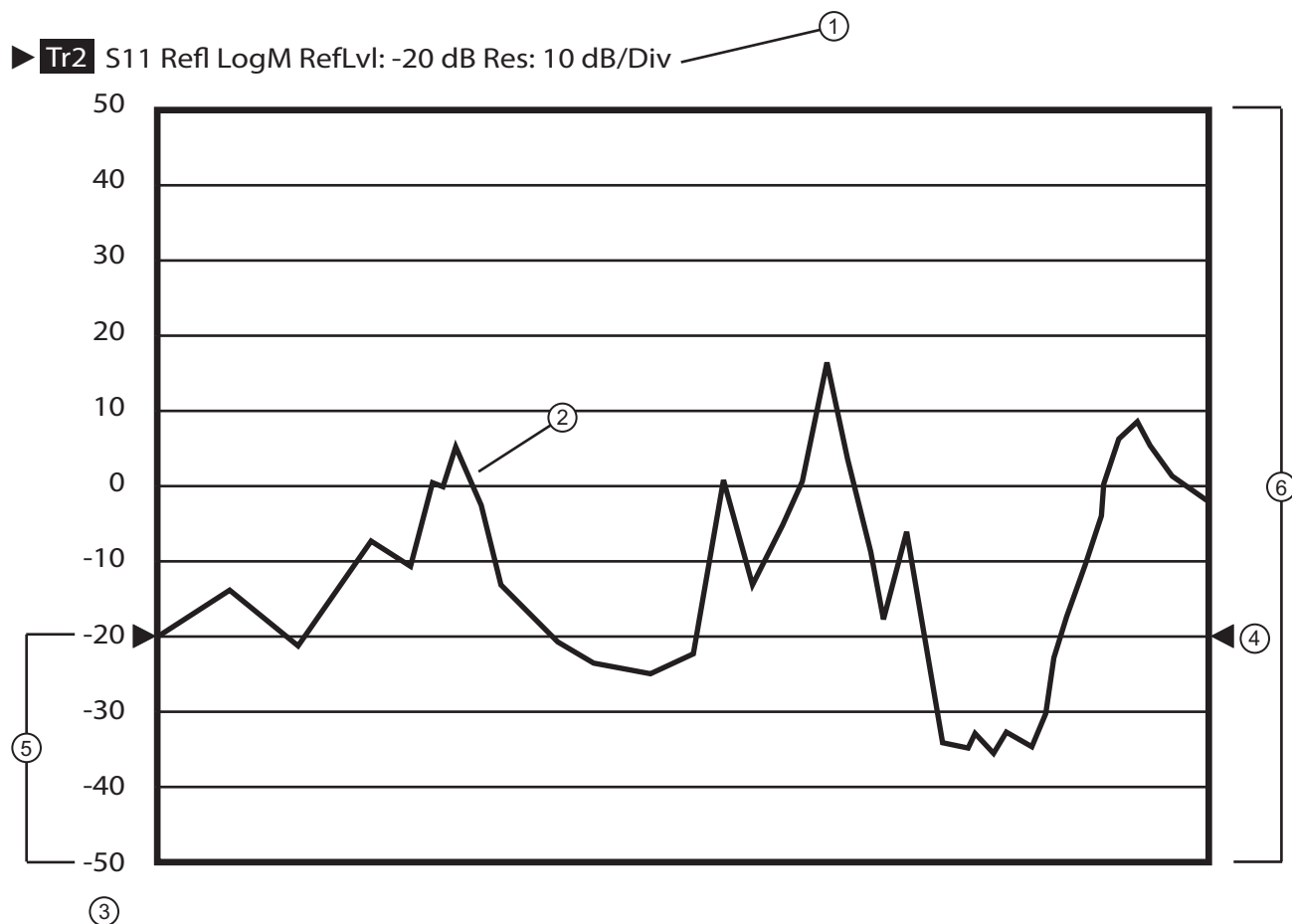


Figure 4-26. Trace Management Dialog Box

## 4-15 Working with Reference Lines and Reference Position

You can manipulate the display elements in a rectilinear trace graph from either the trace itself or from the right-side menus.



- |   |   |
|---|---|
| <ol style="list-style-type: none"> <li>1. Trace Label – The trace label appears above the trace graph. The example above shows Trace 2 measuring S11, displayed on a Log Magnitude graph, with a Reference Level of -20 dB, and a graph resolution of 10 dB per vertical division.</li> <li>2. Response Graph – A typical S11 response graph.</li> <li>3. Resolution in Units per Division – The example shows 10 dB per division.</li> </ol> | <ol style="list-style-type: none"> <li>4. Reference Line Pointers – Reference lines are only available in rectilinear trace graphs and are indicated by the paired arrows on the trace graph display and show the position of the reference value on the Y-axis scale. The example Reference Value is set to -20 dB. Click-hold-and-drag the line pointers to change the reference line value.</li> <li>5. Reference Position – The example Reference Position is set to 3. Click-hold-and-drag the reference position scale to change the position of the graph on the Y-axis up or down. The value of the Reference Line Points does not change.</li> <li>6. Number of Vertical Divisions – The example number of vertical divisions is set to 10.</li> </ol> |
|---|---|

**Figure 4-27.** Trace Display Controls and Settings

## 4-16 Working with Limit Lines

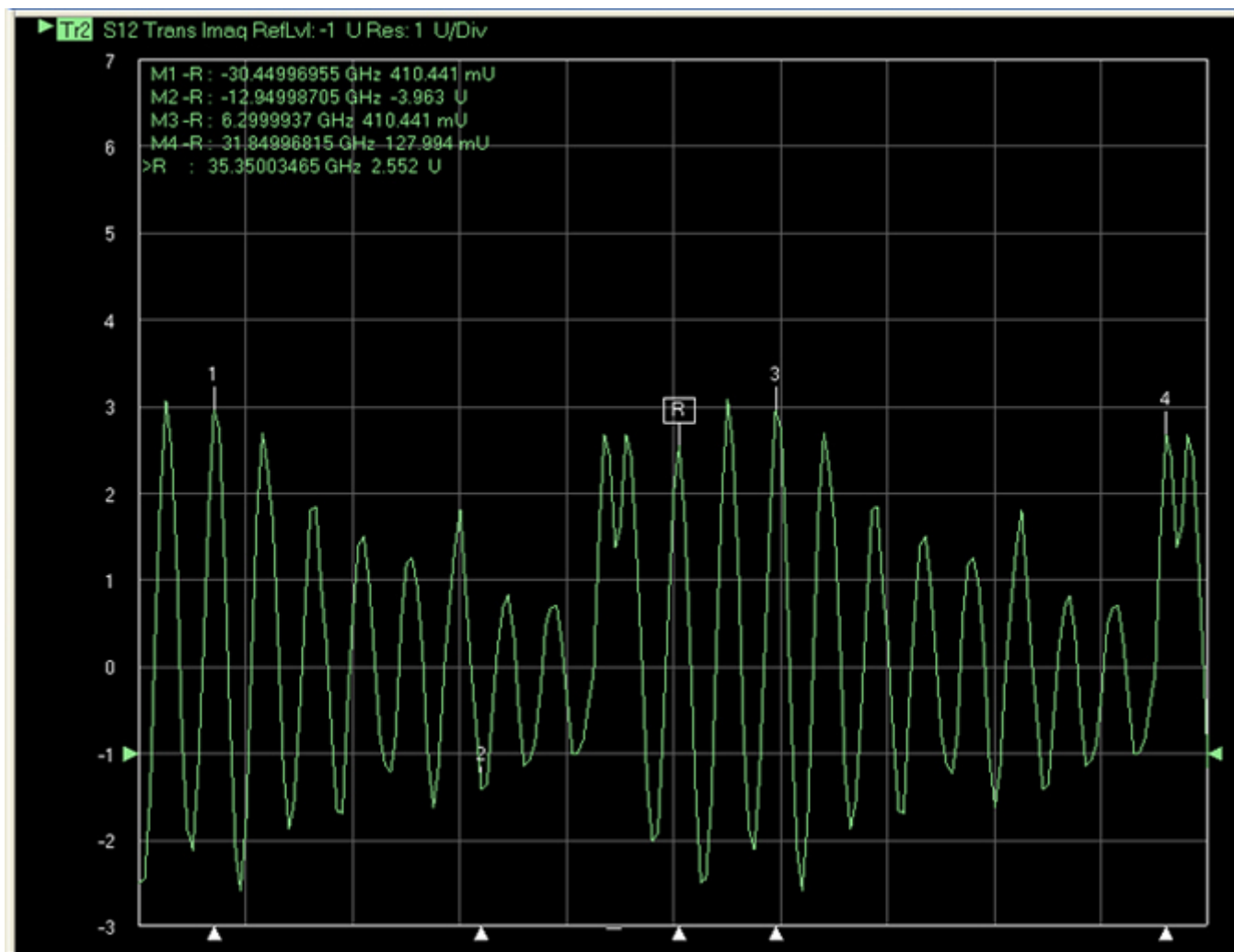
Limit lines are a powerful tool to help compare a set of measured DUT data against specifications or expectations. Limit lines are:

- Can be configured as settable maximum and/or minimum indicators for the value of displayed data on a per-trace basis
- Available only for VectorStar rectilinear displays only
- Not available for VectorStar circular polar and Smith charts.
- Settable in the basic units of each trace
- Rescaled automatically and maintain their correct value if the trace display is rescaled.
- Are limited to a total of 50 segments (upper and lower combined) per-trace.
- For dual displays, such as the Log Mag And Phase display, the segment limit is 50 segments for the top display and 50 segments for the bottom display.



## 4-17 Working with Frequency Blanking

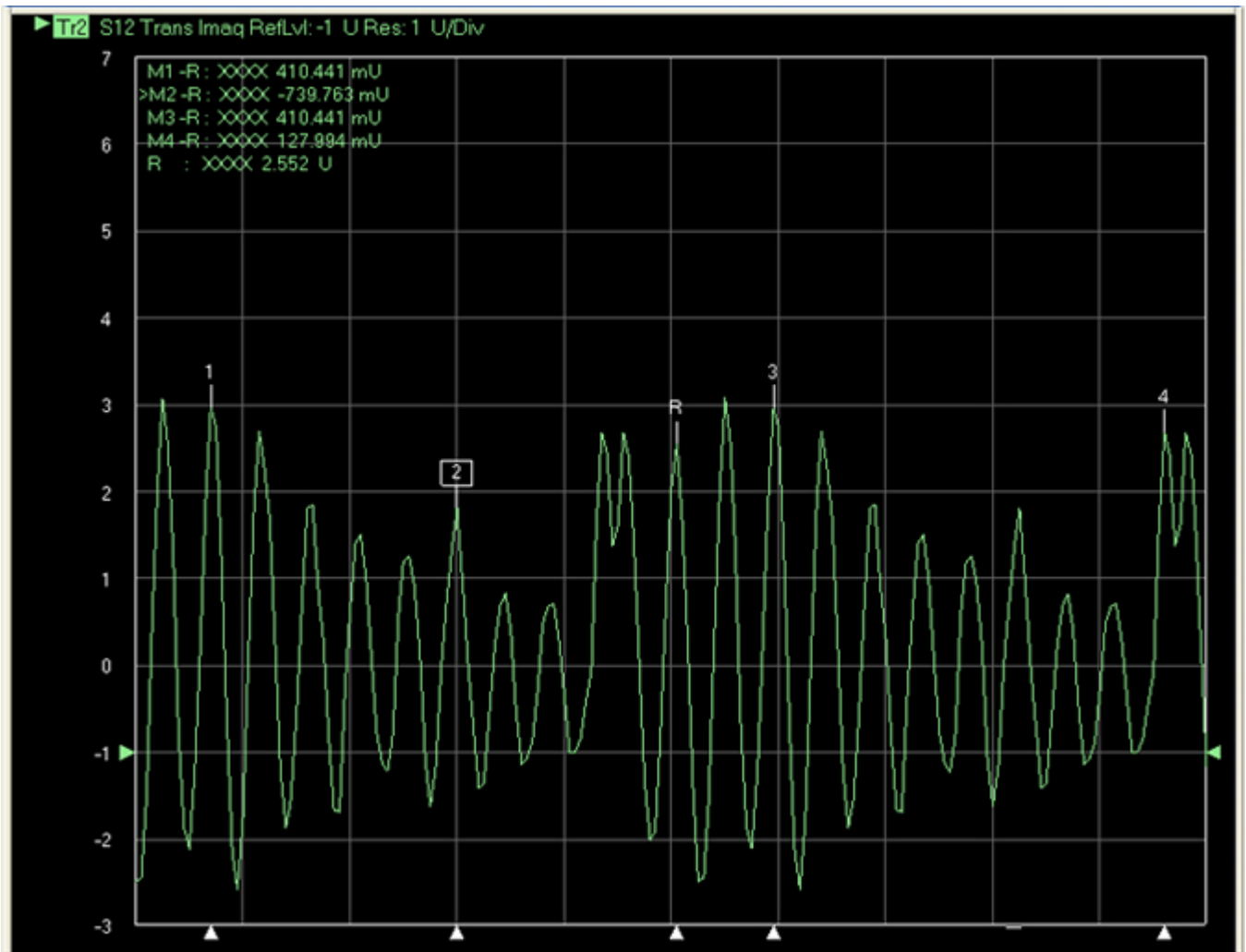
Use frequency blanking when the measured frequency must not appear on the screen display for security or proprietary reasons. Below, [Figure 4-28](#) shows a normal display with five reference markers and their associated frequencies.



Trace display with five markers and frequencies and frequencies displayed.

**Figure 4-28.** Frequency Blanking OFF

After frequency blanking is implemented, the frequency values and units are replaced with XXXX as shown below in [Figure 4-29](#).



Trace display with five markers and frequencies blanked.

**Figure 4-29.** Frequency Blanking ON

### Frequency Blanking Procedure

1. Setup the number of channels, number of traces, and the trace displays as required.
2. Save the setup as a setup file by opening the SAVE SETUP dialog box.
  - MENU BAR | File | Save Setup | SAVE SETUP Dialog Box

### Save the Setup

3. Save the setup with a memorable file name as one of the file types below.
  - Active Channel Setup & Cal (.chx)
  - Active Channel Setup (.stx)
  - Active Channel Setup & Cal Kit (.stc)
  - Active Channel Setup & Cal & Cal Kit (.chc)
  - All Channel Setup & Cal (.cha)
  - All Channel Setup (.sta)

**Blank the Frequency Display**

4. On the right side menu, navigate to the Frequency Blanking button:
  - MAIN | System | SYSTEM | Utility | UTILITY | Frequency Blanking
  - The Frequency Blanking button is a one-way toggle button.
5. Click the Frequency Blanking button.
  - All displayed frequency values and units are blanked and replaced with XXXX as shown above in [Figure 4-29](#) above.

**Restore the Frequency Display**

6. Use the Preset function to return the instrument to its prior setting. Use one of the following methods:
  - **Preset Key**
  - ICON TOOLBAR | Preset icon
  - MENU BAR | Utilities | Preset
7. The instrument is restored to its prior configuration state and frequency values and units are again displayed as in [Figure 4-28](#) above.

# Appendix A — Vector Network Analyzer Primer

## A-1 Appendix Overview

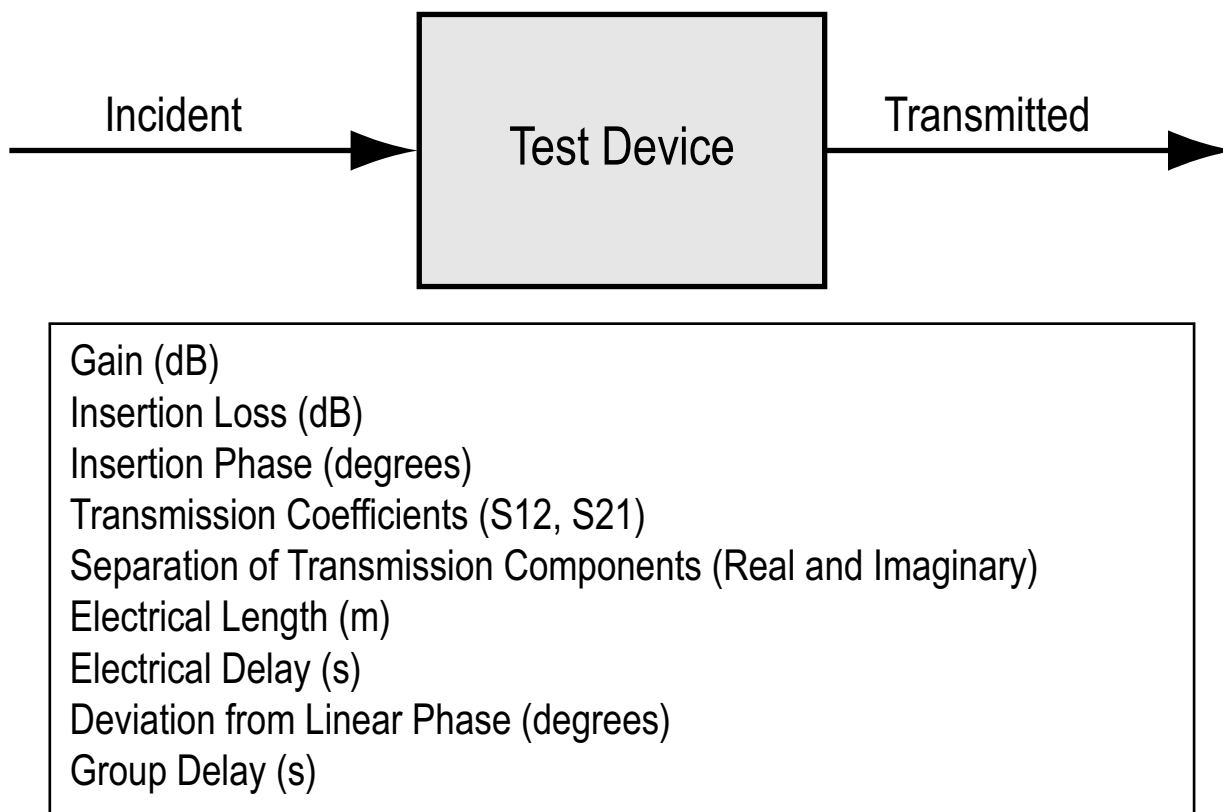
This chapter describes the basic functions of a Vector Network Analyzer (VNA) and how it measures magnitude and phase characteristics of networks, amplifiers, attenuators, and antennas. Scattering parameters (S-parameters) are defined.

This section provides front panel operating and measurement application information and data. It includes discussions on the following topics:

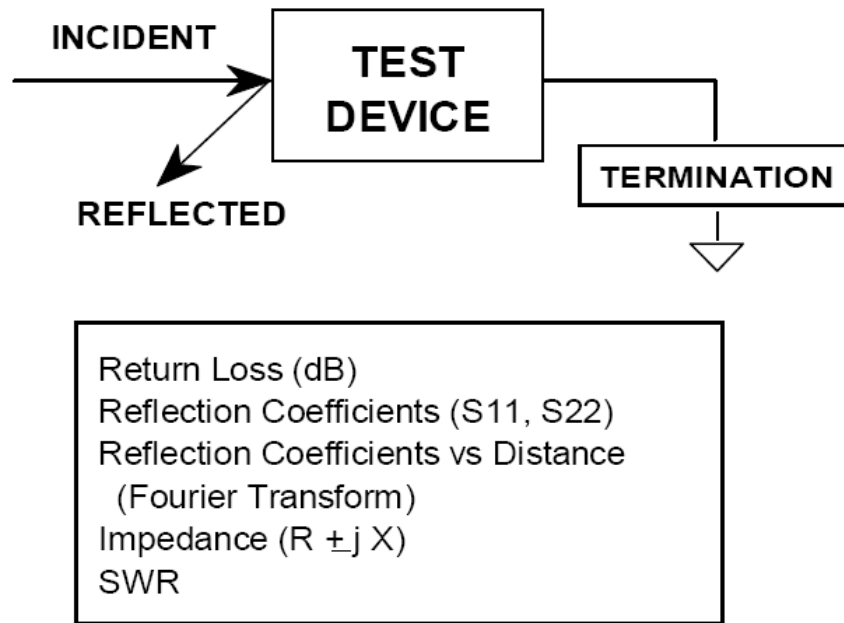
- System description
- General discussion about network analyzers
- Basic measurements and how to make them
- Error correction
- General discussion on test sets

## A-2 General Description

The VectorStar MS464xB Series Vector Network Analyzer (VNA) System measures the magnitude and phase characteristics of networks, amplifiers, attenuators, and antennas. It compares the incident signal that leaves the analyzer with either the signal that is transmitted through the test device or the signal that is reflected from its input. [Figure A-1](#) and [Figure A-2](#) illustrate the types of measurements that the MS464xB Series VNA can make.



**Figure A-1.** Transmission Measurements



**Figure A-2.** Reflection Measurements

## A-3 Instrument Description

The VectorStar MS464xB Series VNA is a self-contained, fully integrated measurement system that includes an optional time domain capability. The system hardware consists of the following:

- Analyzer
- Precision components required for calibration and performance verification

The VectorStar MS464xB Series VNA internal system modules perform the following functions:

### Source Module

This module provides the stimulus to the device under test (DUT). The frequency range of the source and test set modules establish the frequency range of the system. The frequency stability of the source is an important factor in the accuracy (especially phase accuracy) of the network analyzer. Hence, the MS464xB Series VNA always phase locks the source to an internal 10 MHz crystal reference.

### Test Set Module

The test set module routes the stimulus signal to the DUT and samples the reflected and transmitted signals. The type of connector used is important, as is the “Auto Reversing” feature. Auto Reversing means that it applies the stimulus signal in both the forward and reverse direction. The direction is reversed automatically. This saves you from having to reverse the test device physically to measure all four scattering parameters (S-parameters). Frequency conversion occurs in the test set module.

### Analyzer Module

The analyzer module receives, and interprets the 3rd IF signal for phase and magnitude data. It then displays the results of this analysis on a large color display. This display can show all four S-parameters simultaneously. In addition to the installed display, you can also view the measurement results on an external color monitor.

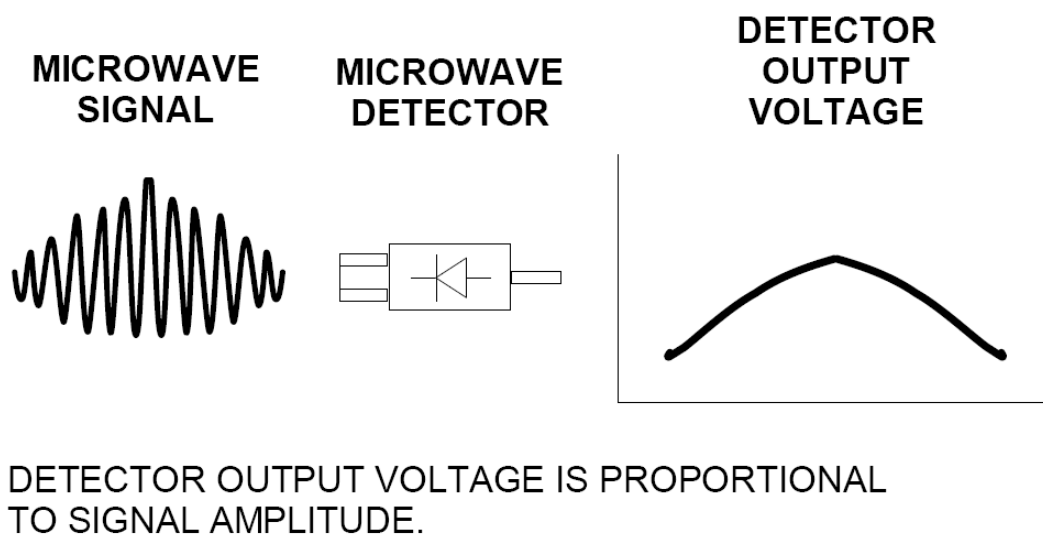
## A-4 Network Analyzers

We will begin this discussion with a subject familiar to most Anritsu customers: scalar network analysis. After showing comparisons, we will proceed to the fundamentals of network analyzer terminology and techniques. This discussion serves as an introduction to topics presented in greater detail later in this section. This discussion will touch on new concepts that include the following:

- Reference Delay
- S-parameters: what they are and how they are displayed
- Complex Impedance and Smith Charts

### Scalar Analyzer Comparison

## SCALAR NETWORK ANALYZERS



**Figure A-3.** Scalar Analyzer Detection

Network Analyzers do everything that scalar analyzers do except display absolute power, although absolute power can be displayed on a network analyzer through the use of a receiver calibration. In addition, they add the ability to measure the phase characteristics of microwave devices and allow greater dynamic range.

If all a Network Analyzer added was the capability for measuring phase characteristics, its usefulness would be limited. While phase measurements are important in themselves, it is the availability of this phase information that unlocks many new features for complex measurements. These features include Smith Charts, Time Domain, and Group Delay. Phase information also allows greater accuracy through *vector error correction* of the measured signal.

First, let us look at scalar network analyzers (SNAs). SNAs measure microwave signals by converting them to a DC voltage using a diode detector (Figure A-3). This DC voltage is proportional to the magnitude of the incoming signal. The detection process, however, ignores any information regarding the phase of the microwave signal.

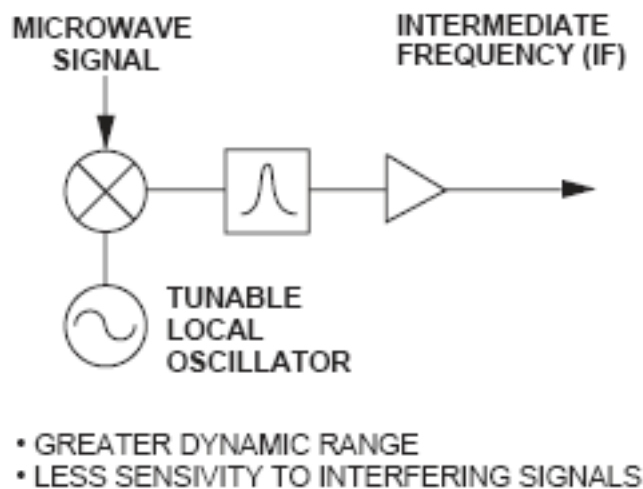
In a vector network analyzer, access is needed to both the magnitude and phase of a microwave signal. There are several different ways to perform the measurement. The method Anritsu employs (called Harmonic Sampling or Harmonic Mixing) is to down-convert the signal to a lower intermediate frequency (IF). This signal can then be measured directly by a tuned receiver. The tuned receiver approach gives the system greater dynamic range. The system is also much less sensitive to interfering signals, including harmonics.

### Vector Network Analyzer Basics

The vector network analyzer is a tuned receiver (Figure A-4). The microwave signal is down converted into the pass band of the IF. To measure the phase of this signal, we must have a reference to compare it with. If the phase of a signal is 90 degrees, it is 90 degrees different from the reference signal (Figure A-5). The network analyzer would read this as  $-90$  degrees, since the test signal is delayed by 90 degrees with respect to the reference signal.

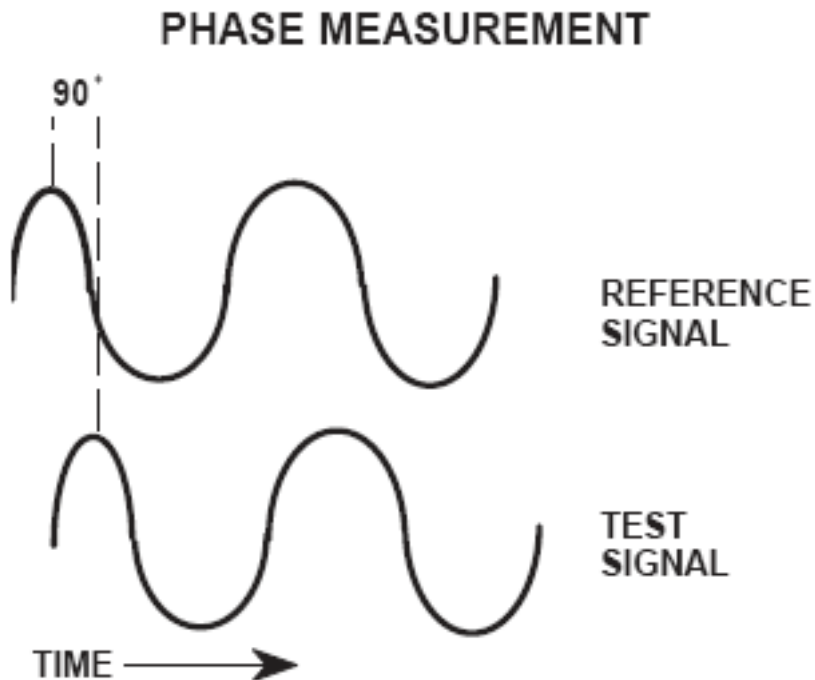
This phase reference can be obtained by splitting off some of the microwave signal before the measurement (Figure A-7).

#### A NETWORK ANALYZER IS A TUNED RECEIVER

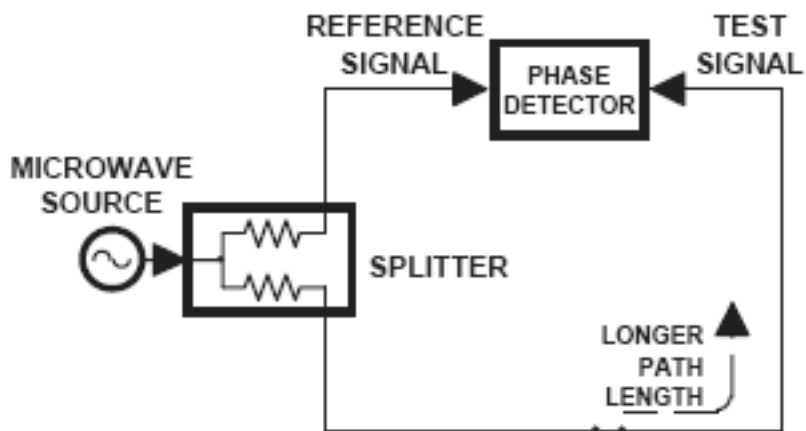


**Figure A-4.** Network Analyzer as a Tuned Receiver

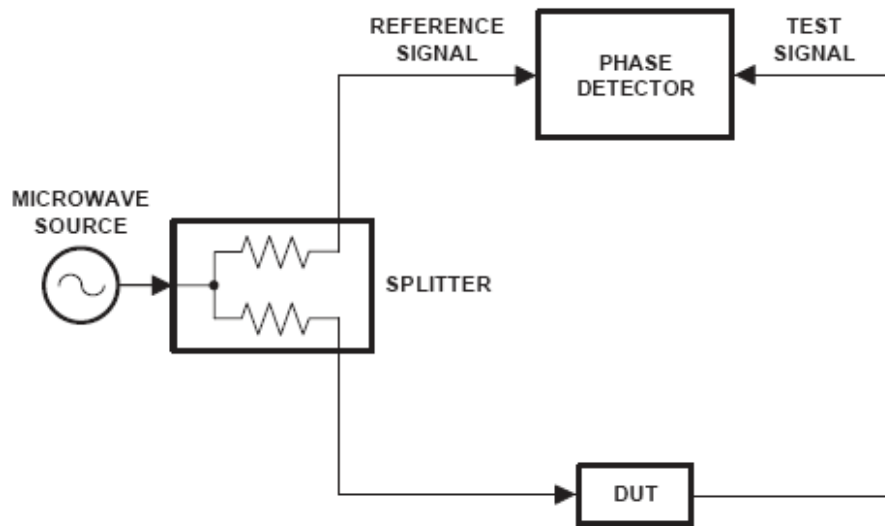




**Figure A-5.** Signals with a 90 Degree Phase Difference



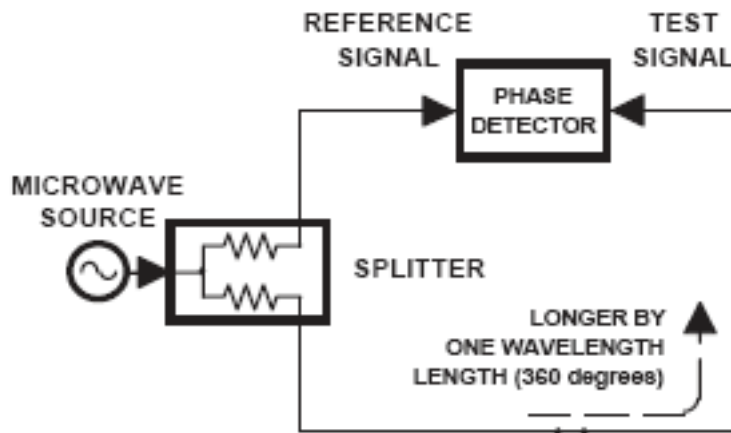
**Figure A-6.** Split Signal where a Length of Line Replaces the DUT



**Figure A-7.** Splitting the Microwave Signal

The phase of the microwave signal after it has passed through the device under test (DUT) is then compared with the reference signal. A network analyzer test set automatically samples the reference signal, so no external hardware is needed.

Let us consider for a moment that you remove the DUT and substitute a length of transmission line (Figure A-6). Note that the path length of the test signal is longer than that of the reference signal. Now let us see how this affects our measurement.



**Figure A-8.** Split Signal where Path Length is Different by Exactly One Wavelength

Assume that we are making a measurement at 1 GHz and that the difference in path-length between the two signals is exactly 1 wavelength. This means that test signal is lagging the reference signal by 360 degrees (Figure A-8). We cannot really tell the difference between one sine wave maxima and the next (they are all identical), so the network analyzer would measure a phase difference of 0 degrees.

Now consider that we make this same measurement at 1.1 GHz. The frequency is higher by 10 percent so therefore the wavelength is shorter by 10 percent. The test signal path length is now 0.1 wavelength longer than that of the reference signal (Figure A-9). This test signal is:

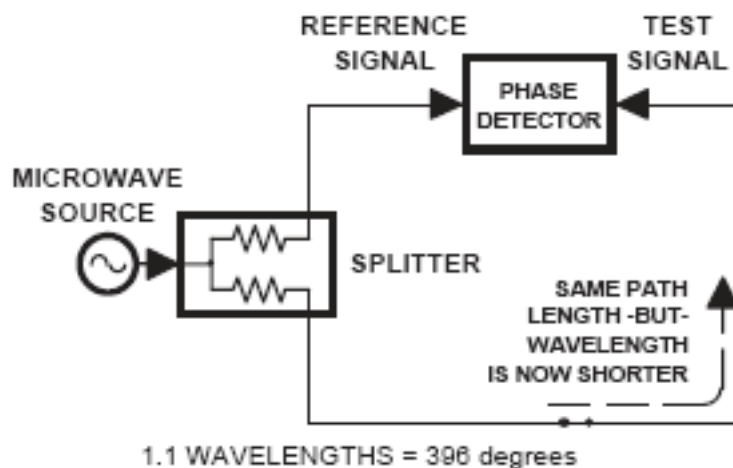
$$1.1 \times 360 = 396 \text{ degrees}$$

This is 36 degrees different from the phase measurement at 1 GHz. The network analyzer will display this phase difference as  $-36$  degrees. The test signal at 1.1 GHz is delayed by 36 degrees more than the test signal at 1 GHz.

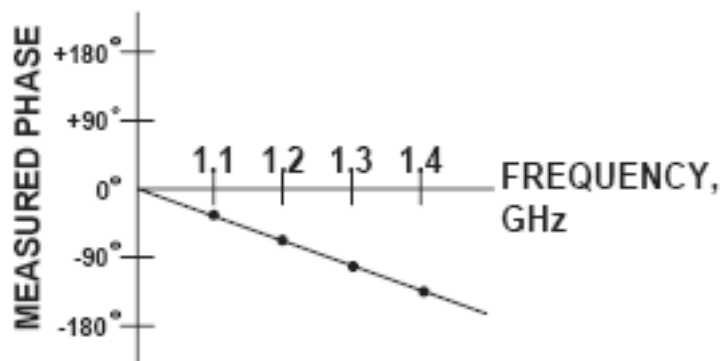
You can see that if the measurement frequency is 1.2 GHz, we will get a reading of  $-72$  degrees,  $-108$  degrees for 1.3 GHz, etc. (Figure A-10). There is an electrical delay between the reference and test signals. For this delay we will use the common industry term of reference delay.

You also may hear it called phase delay. In older network analyzers you had to equalize the length of the reference arm with that of the test arm to make an appropriate measurement of phase vs. frequency.

To measure phase on a DUT, we want to remove this phase-change-vs.-frequency due to changes in the electrical length. This will allow us to view the actual phase characteristics. These characteristics may be much smaller than the phase change due to electrical length difference.

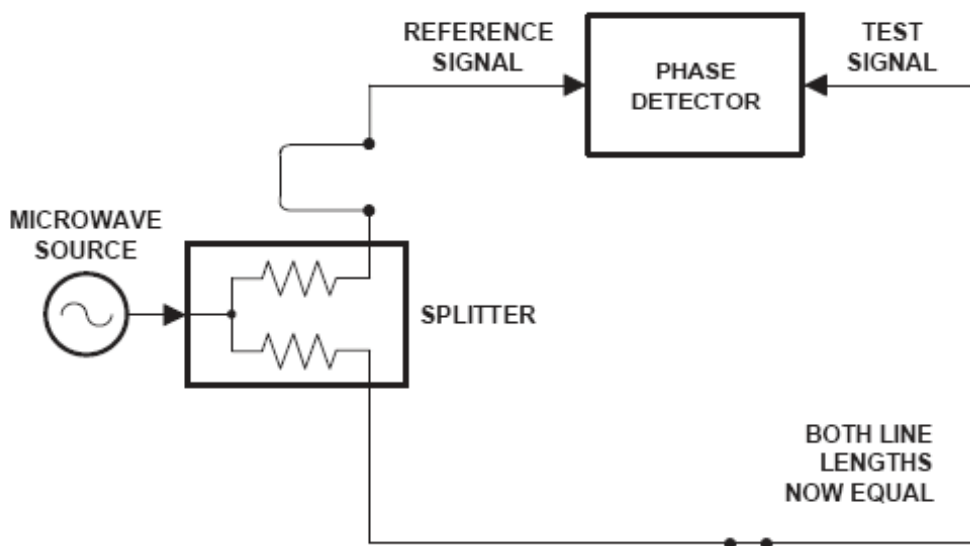


**Figure A-9.** Split Signal where Path Length is Longer than One Wavelength



**Figure A-10.** Electrical Delay

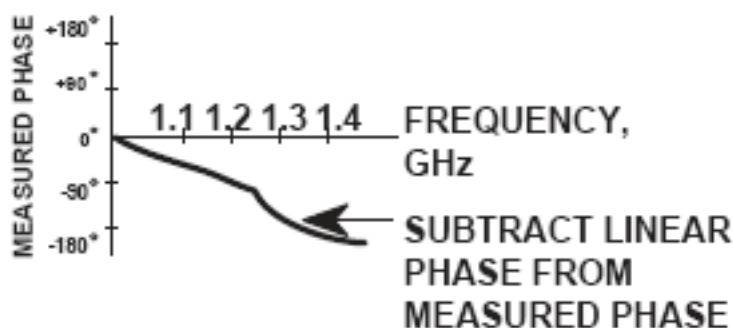
There are two ways of accomplishing this. The most obvious way is to insert a length of line into the reference signal path to make both paths of equal length (Figure A-11). With perfect transmission lines and a perfect splitter, we would then measure a constant phase as we change the frequency. The problem using this approach is that we must change the line length with each measurement setup.



**Figure A-11.** Split Signal where Paths are of Equal Length

Another approach is to handle the path length difference in software. [Figure A-12](#) displays the phase-vs.-frequency of a device. This device has different effects on the output phase at different frequencies. Because of these differences, we do not have a perfectly linear phase response. We can easily detect this phase deviation by compensating for the linear phase. The size of the phase difference increases linearly with frequency so we can modify the phase display to eliminate this delay.

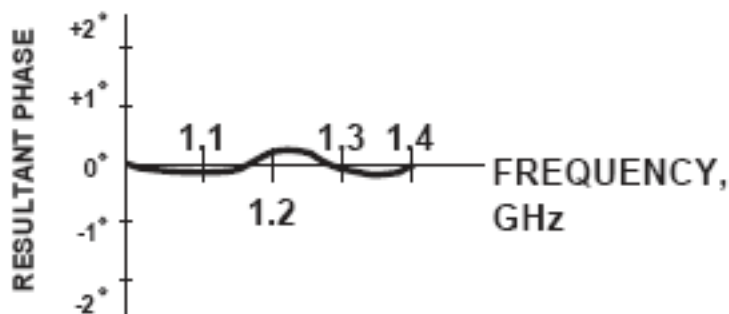
---



**Figure A-12.** Phase Difference Increases Linearly with Frequency

The VectorStar MS464xB Series VNA offers automatic reference delay compensation with the push of a button. [Figure A-13](#) shows the resultant measurement when we compensate path length. In a system application you can usually correct for length differences; however, the residual phase characteristics are critical.

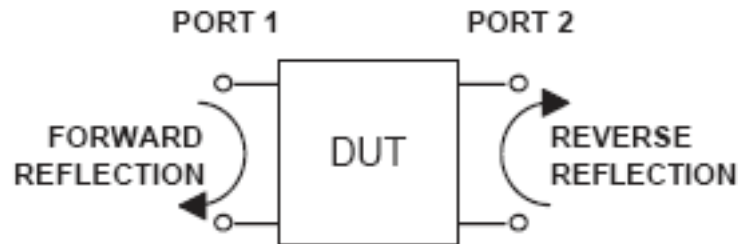
---



**Figure A-13.** Resultant Phase with Path Length

Now let us consider measuring the DUT. Consider a two port device; that is, a device with a connector on each end. What measurements would be of interest?

First, we could measure the reflection characteristics at either end with the other end terminated into 50-ohms. If we designate one end as the normal place for the input that gives a reference, we can then define the reflection characteristics from the reference end as forward reflection, and those from the other end as reverse reflection (Figure A-14).



**Figure A-14.** Forward and Reverse Measurements

Second, we can measure the forward and reverse transmission characteristics. However, instead of saying “forward,” “reverse,” “reflection,” and “transmission” all the time, we use a shorthand. That is all that S-parameters are, a shorthand! The “S” stands for scattering. The second number is the device port that the signal is being injected into, while the first is the device port that the signal is leaving. S11, therefore, is the signal being injected into port 1 relative to the signal leaving port 1. The four scattering parameters (Figure A-15) are:

- S11: Forward Reflection
- S21: Forward Transmission
- S22: Reverse Reflection
- S12: Reverse Transmission

S-parameters can be displayed in many ways. An S-parameter consists of a magnitude and a phase. We can display the magnitude in dB, just like a scalar network analyzer. We often call this term log magnitude. We can display phase as “linear phase” (Figure A-16). As discussed earlier, we cannot tell the difference between one cycle and the next. Therefore, after going through 360 degrees, we are back to where we began. We can display the measurement from  $-180$  to  $+180$  degrees. The  $-180$  to  $+180$  degree approach is more common. It keeps the display discontinuity removed from the important 0 degree area used as the phase reference.

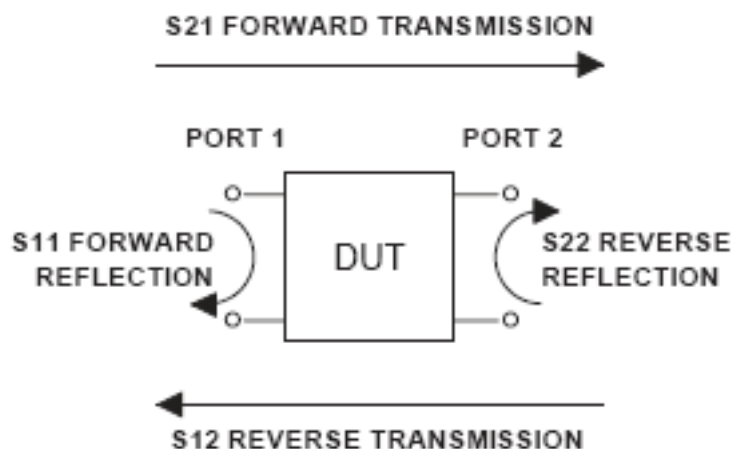


Figure A-15. S-Parameters



Figure A-16. Linear Phase with Frequency Waveform

There are several ways in which all the information can be displayed on one trace.

## A-5 Polar Display

One method is a polar display (Figure A-17). The radial parameter (distance from the center) is magnitude. The rotation around the circle is phase. We sometimes use polar displays to view transmission measurements, especially on cascaded devices (devices in series). The transmission result is the addition of the phase and log magnitude (dB) information of each device's polar display.

### Resistive and Reactive Terms

As we have discussed, the signal reflected from a DUT has both magnitude and phase. This is because the impedance of the device has both a resistive and a reactive term of the form  $r+jx$ . We refer to the  $r$  as the real or resistive term, while we call  $x$  the imaginary or reactive term. The  $j$ , which we sometimes denote as  $i$ , is an imaginary number.

It is the square root of  $-1$ . If  $x$  is positive, the impedance is inductive; if  $x$  is negative, the impedance is capacitive.

The size and polarity of the reactive component  $x$  is important in impedance matching. The best match to a complex impedance is the complex conjugate. This complex-sounding term simply means an impedance with the same value of  $r$  and  $x$ , but with  $x$  of opposite polarity.

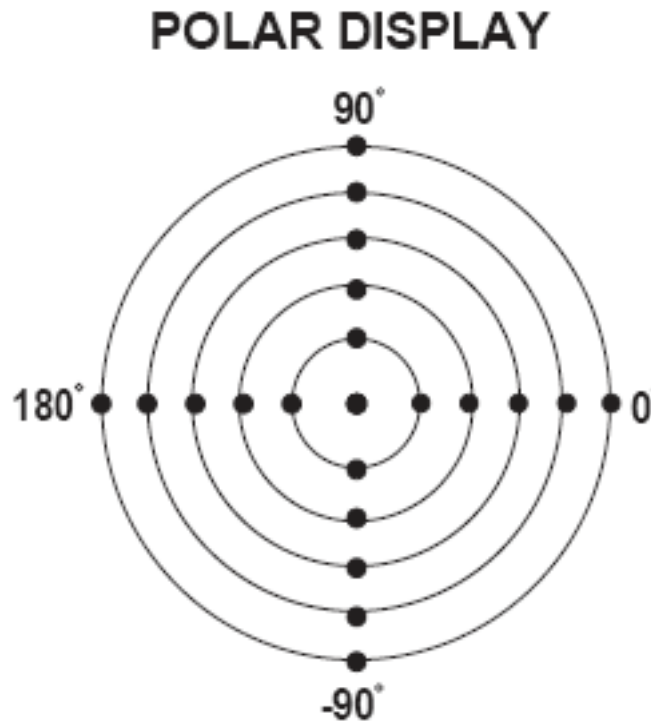
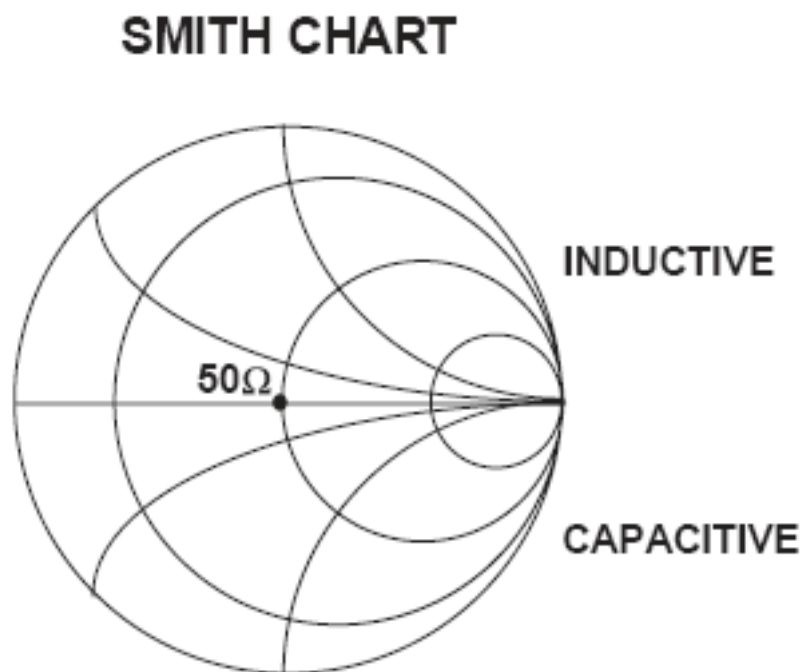


Figure A-17. Polar Display



## A-6 Smith Chart

The complex conjugate is best analyzed using a Smith Chart (Figure A-18), which is a plot of  $r$  and  $x$ . To display all the information on a single S-parameter requires one or two traces, depending upon the format we want. A very common requirement is to view forward reflection on a Smith Chart (one trace) while observing forward transmission in Log Magnitude and Phase (two traces). Let us see how to accomplish this in the VectorStar MS464xB Series VNA.



**Figure A-18.** Smith Chart

The VectorStar MS464xB Series VNA has 16 channels and each channel can display a complete S-parameter in any format on up to 16 traces. All four S-parameters can be seen simultaneously in any desired format. A total of 16x16 traces can be viewed at the same time. While this is a lot of information to digest, the large color display of the VectorStar MS464xB Series VNA makes recognizing and analyzing the data surprisingly easy.

Another important parameter we can measure when phase information is available is group delay. In linear devices, the phase change through the DUT is linear-with-frequency. Thus, doubling the frequency also doubles the phase change. An important measurement, especially for communications system users, is the rate of change-of-phase-vs.-frequency (group delay). If the rate of phase-change-vs.-frequency is not constant, the DUT is nonlinear. This nonlinearity can create distortion in communications systems.

### Measurement Error Correction

Since we can measure microwave signals in both magnitude and phase, it is possible to correct for six major error terms:

- Source Test Port Match
- Load Test Port Match
- Directivity
- Isolation
- Transmission Frequency Response
- Reflection Frequency Response

We can correct for each of these six error terms in both the forward and reverse directions, hence the name 12-term error correction. Since 12-term error correction requires both forward and reverse measurement information, the test set must be *reversing*. “Reversing” means that it must be able to apply the measurement signal in either the forward or reverse direction.

---

### MAGNITUDE AND PHASE OF EACH ERROR SIGNAL IS MEASURED



THEN THE RESULTANT VECTOR IS  
APPLIED MATHEMATICALLY, HENCE  
VECTOR ERROR CORRECTION

---

**Figure A-19.** Magnitude and Phase

To accomplish this error correction, we measure the magnitude and phase of each error signal (Figure A-19). Magnitude and phase information appear as a vector that is mathematically applied to the measurement signal. This process is termed *vector error correction*.



# Appendix B — Initial Checkout Procedures

## B-1 Introduction

The initial checkout procedure chapter describes the detailed procedures for initial operational checkout (such as those performed by incoming quality inspectors) to ensure that the MS464xB Series VNA is fully operational. A quick check procedure is described along with how to determine the instrument's installed options, current operating system, application software, and firmware versions. Other procedures provided are self-test, non-ratio power, high-level signal, and system noise floor test.

For full performance verification and calibration routines, see the following documents:

- **VectorStar MS464xB Series VNA Measurement Guide**
- **VectorStar MS464xB Series VNA Maintenance Manual**

### Warning



This equipment can not be repaired by the operator. DO NOT attempt to remove the equipment covers or to disassemble internal components. Only qualified service technicians with a knowledge of electrical fire and shock hazards should service this equipment. There are high-voltage parts in this equipment presenting a risk of severe injury or fatal electric shock to untrained personnel. In addition, there is a risk of damage to precision components.

## B-2 Checkout Introduction

This chapter provides quick operational checkout procedures that may be used by incoming inspectors to ensure that the MS464xB Series Vector Network Analyzer is operational. The following procedures are provided:

- Self test procedure
- Non-ratio power procedure
- High-level noise test
- System noise floor test

## B-3 Required Equipment

The following equipment is required for the procedures in this chapter:

- Flexible microwave cable (through line)

## B-4 Self Test Procedure

### Overview

This procedure uses internal routines to test basic system operation and performance. The procedure uses a mixture of commands from:

- Drop-down menus from the top Menu Bar
- Icons from the Icon Toolbar
- Application menus and buttons from the right-side user interface

## Procedure

1. Before starting the performance tests:
  - a. Locate the appropriate AC source with:
    - 90 VAC minimum to 264 VAC maximum
    - Single phase
    - 47 to 63 Hz power factor controlled
    - Power output capable of 350 VA maximum
  - b. Connect the instrument to the AC source with the provided power cable.
  - c. On the instrument rear panel, turn the **AC Input On/Off (I/O)** switch to ON (I).
  - d. On the instrument front panel, press the instrument power key which is labeled **Standby Operate Key**.
    - The key is located on the left side of the front panel, just above the test loops and the grounding banana jack.
  - e. The green **Operate LED** illuminates and system is on.

<b>Note</b>	Allow the system to warm up for at least 90 minutes to ensure operation to performance specifications.
-------------	--

2. Perform an instrument self-test to ensure that the VNA is operating properly.
  - a. To start the instrument self test, use the Menu Bar at the top of the display.
  - b. Select MENU BAR | Utilities | System.
  - c. The right side SYSTEM menu appears.

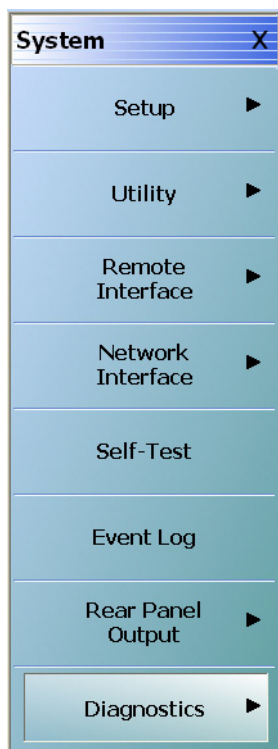
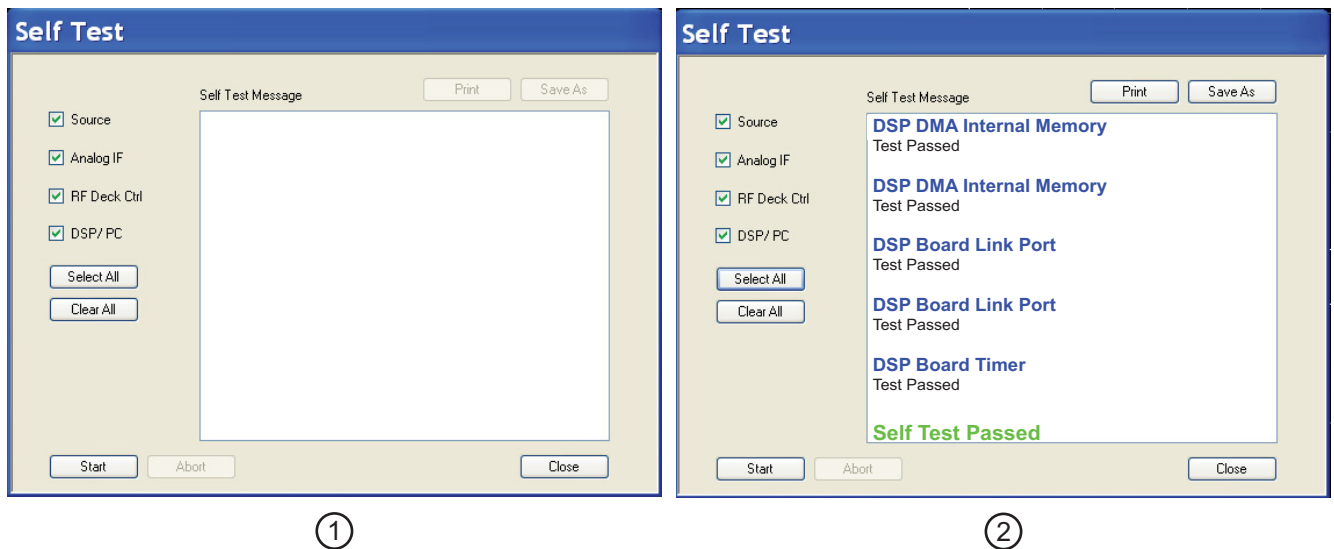


Figure B-1. SYSTEM Menu

3. Select the Self-Test button. The SELF TEST dialog box appears.



1. SELF TEST dialog box before test at left.

2. SELF TEST dialog box after successful test at right.

**Figure B-2.** SELF TEST Dialog Box

### Self-Test Selections

4. Select all check boxes:
  - Source
  - Analog IF
  - RF Deck Ctrl
  - DSP/PC

### Self-Test Results

5. Click Start to begin the initial self-test process.
  - If the test is successful, the “Self Test Passed” message is displayed.
6. Click Close to exit the dialog box.

## B-5 Non-Ratio Power Procedure

### Overview

This test verifies that each individual receiver operates properly. Measurement calibration of the system is *not* required for this test. This test requires that you press specified front panel keys, or use a mouse to make choices from the displayed menus and is valid for all instrument model and option combinations. The key and menu selections used in this test are shown below.

### Procedure

1. Connect Test Ports 1 and 2 together using a high-quality through line.
2. At the top of the display, select MENU BAR | Utilities | System. The right-side SYSTEM menu appears:
  - Click Setup. The SETUP menu appears.
  - Click Preset Setup. The PRESET SETUP menu appears.
  - Select Default.
    - The default setting associates both the front panel **Preset Key** and the MENU BAR | Utilities | Preset command with the factory-default preset configuration.
3. Reset the VNA by pressing the front panel **Preset Key**.
  - The VNA resets to the factory-default as-shipped configuration.
  - The right-side menu returns to the MAIN MENU.
4. At the top of the display, select MENU BAR | Utilities | System.
  - The right side SYSTEM menu appears.
5. On the right-side, select SYSTEM | Utility | UTILITY | Factory Receiver Cal and toggle the Factory Receiver Cal button to OFF.

### Check Frequency and Set Power

6. On the right side MAIN MENU, select Frequency.
  - a. The FREQUENCY menu appears.
  - b. Observe the displayed Frequency menu.
  - c. Note that the Start and Stop values are the low-end and high-end frequencies.
7. At the top of the display, select MENU BAR | Channel | Power.
  - a. The right side POWER menu appears.
  - b. Click on the Port 1 Power button.
  - c. In the displayed field toolbar, enter -10.0000 dBm.
  - d. Click the X at the end of the toolbar to close it.

### Set Channel and Trace Display

8. Select the upper left LCD channel using the mouse by clicking on Tr1 S11 Refl Smith Imped.
  - The trace name has additional resolution and unit information appended to the displayed label.
9. At the top of the display, select MENU BAR | Trace | Display. The right side DISPLAY menu appears.
  - a. Click the Trace Format button, the TRACE FORMAT menu appears.
  - b. Select Log Mag.

10. On the icon toolbar, select the Response icon.
  - a. The RESPONSE menu appears.
  - b. Click on User-Defined, the USER DEFINED menu appears.
  - c. Click on Numerator and on the NUMERATOR menu, set it to A1.
  - d. Click on Denominator and on the DENOMINATOR menu, set it to 1.
  - e. Set Driver Port to Port 1.

#### Select Lower Left Channel

11. Select the lower left channel by clicking trace label that starts with Tr3 S21 Trans LogM+P.
  - The trace name has additional resolution and unit information appended to the displayed label.
12. At the top of the display, select MENU BAR | Trace | Display. The right side DISPLAY menu appears.
  - a. Click on the Trace Format button, the TRACE FORMAT menu appears.
  - b. Select Log Mag.
13. On the icon toolbar, select the Response icon. The RESPONSE menu appears.
  - a. Click on User-Defined, the USER DEFINED menu appears.
  - b. Click on Numerator and on the NUMERATOR menu, set it to B2.
  - c. Click on Denominator and on the DENOMINATOR menu, and set it to 1.
  - d. Set Driver Port to Port 1.

#### Select Upper Right LCD Channel

14. Select the upper right LCD channel using the mouse by clicking on Tr2 S12 Trans Log M+P.
  - The trace name has additional resolution and unit information appended to the displayed label.
15. At the top of the display, select MENU BAR | Trace | Display. The right side DISPLAY menu appears.
  - a. Click on the Trace Format button, the TRACE FORMAT menu appears.
  - b. Select Log Mag.
16. At the top of the display, select MENU BAR | Trace | Response. The right side RESPONSE menu appears.
  - a. Click on User-Defined, the USER DEFINED menu appears.
  - b. Click on Numerator and on the NUMERATOR menu, and set it to A2.
  - c. Click on Denominator and on the DENOMINATOR menu, set it to 1.
  - d. Set Driver Port to Port 2.

#### Select Lower Right Channel

17. Select the lower right channel by clicking on Tr4 S22 Refl Smith Imped.
  - The trace name has additional resolution and unit information appended to the displayed label.
18. On the top menu bar, select MENU BAR | Trace | Display. The right side DISPLAY menu appears.
  - Click on the Trace Format button. The TRACE FORMAT menu appears.
  - Select Log Mag.
19. On the top menu bar, select MENU BAR | Trace | Response. The RESPONSE menu appears.
  - a. Click on User-Defined, the USER DEFINED menu appears.
  - b. Click on Numerator and on the NUMERATOR menu, and set it to B1.
  - c. Click on Denominator and on the DENOMINATOR menu, and set it to 1.
  - d. Set Driver Port to Port 2.



**Review Amplitude Slopes for Maximum and Minimum Values**

20. After at least one complete forward and reverse sweep has occurred, verify that the maximum-value to minimum-value amplitude slope meets the specification below in [Table B-1](#).

**Table B-1.** Maximum-Value to Minimum-Value Amplitude Slope Specifications

<b>Model</b>	<b>F-High</b>	<b>Test Channel (b1,b2) Max</b>	<b>Test Channel (b1,b2) Min</b>	<b>Ref Channel (a1,a2) Max</b>	<b>Ref Channel (a1,a2) Min</b>
MS4642B	20 GHz	-10 dB	-55 dB	-20 dB	-50 dB
MS4642B-06x	20 GHz	-10 dB	-55 dB	-20 dB	-50 dB
MS4642B-051	20 GHz	-10 dB	-55 dB	-20 dB	-50 dB
MS4644B	40 GHz	-10 dB	-55 dB	-20 dB	-50 dB
MS4644B-06x	40 GHz	-10 dB	-55 dB	-20 dB	-50 dB
MS4644B-051	40 GHz	-10 dB	-55 dB	-20 dB	-50 dB
MS4645B	50 GHz	-10 dB	-55 dB	-20 dB	-50 dB
MS4645B-06x	50 GHz	-10 dB	-55 dB	-20 dB	-50 dB
MS4645B-051	50 GHz	-10 dB	-55 dB	-20 dB	-50 dB
MS4647B	70 GHz	-10 dB	-55 dB	-20 dB	-50 dB
MS4647B-06x	70 GHz	-10 dB	-55 dB	-20 dB	-50 dB
MS4647B-051	70 GHz	-10 dB	-55 dB	-20 dB	-50 dB

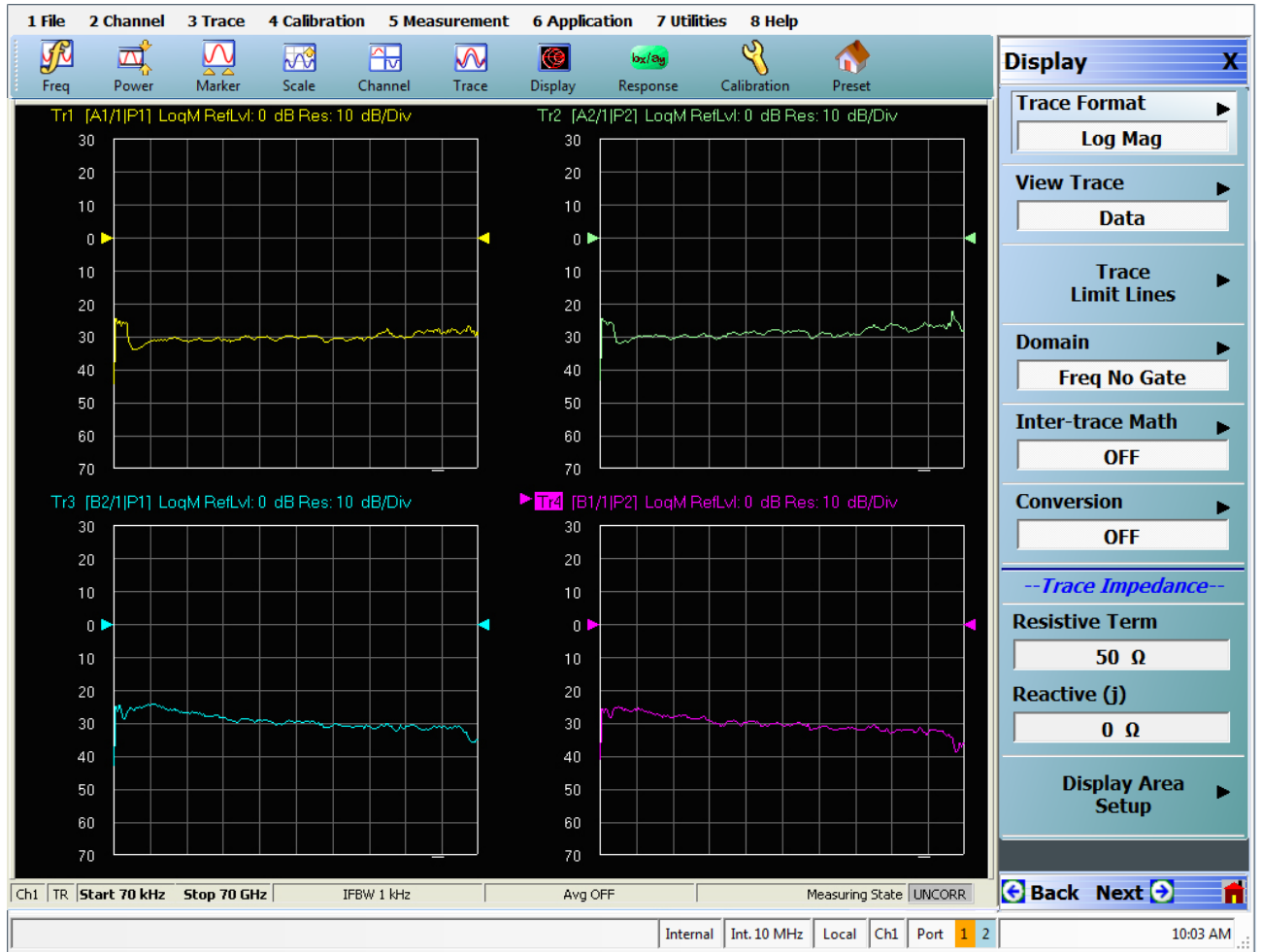
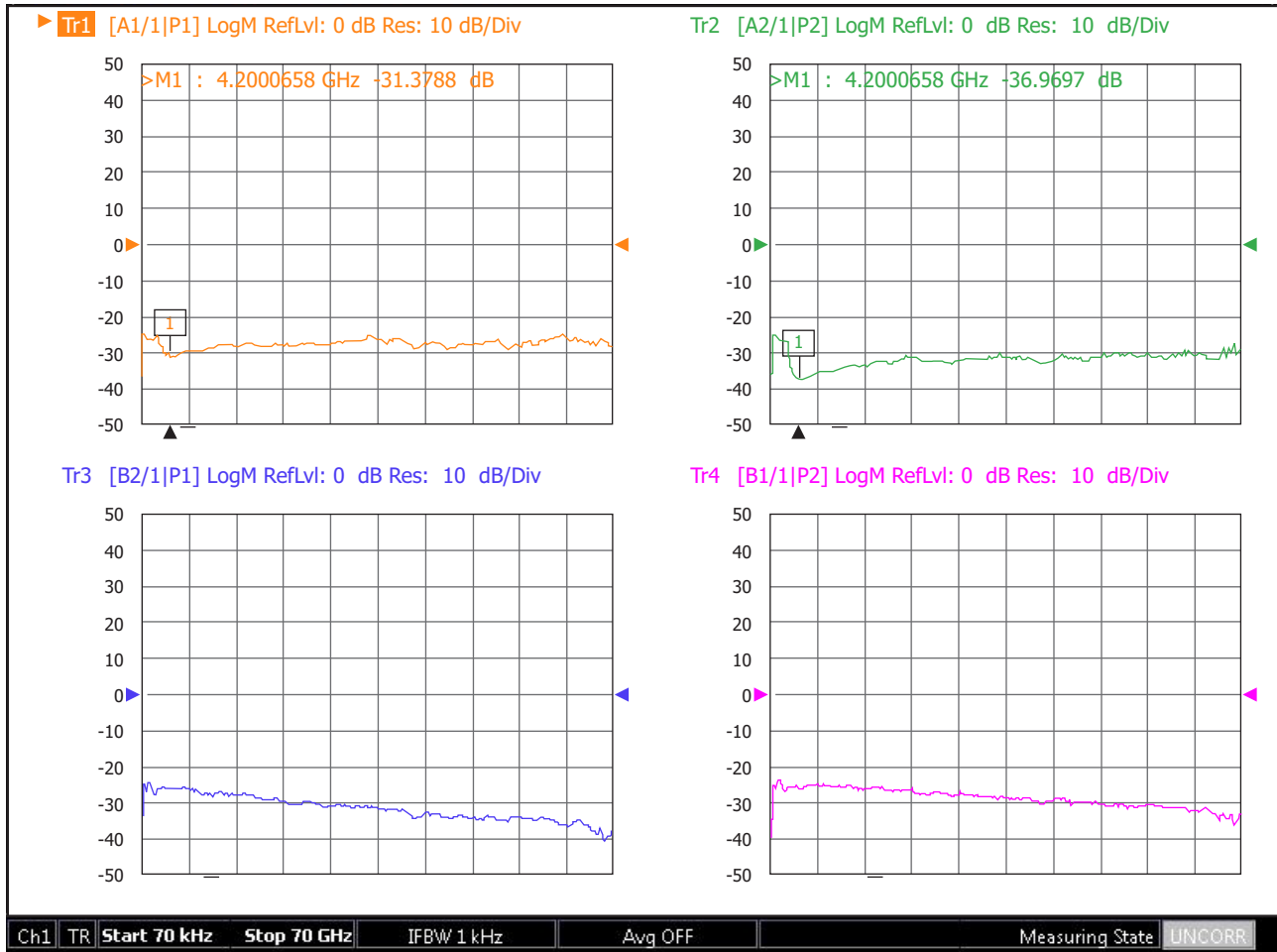


Figure B-3. Typical Display for a unit without options 31 and 8x, 31, and 32, or 31, 32, and 8x.



**Figure B-4.** Typical display for a unit with options 31 and 8x, 31 and 32, or 31, 32, and 8x.

Conclude this test by pressing the front panel **Preset Key** to return the system to the factory default preset condition.

## B-6 High Level Noise Test

### Overview

This test verifies that high-level signal noise will not significantly affect the accuracy of subsequent measurements. Measurement calibration of the system is not required for this test. This test requires that you press specified front panel keys, or use a mouse to make choices from the displayed menu(s). The key and menu selections used in this test are shown below. The test below is valid for all models and option combinations.

### Procedure

1. Connect Test Ports 1 and 2 together using a high-quality through line.
2. At the top of the display, select MENU BAR | Utilities | System. The right side SYSTEM menu appears.
  - a. Click on Setup. The SETUP menu appears.
  - b. Click on Preset Setup. The PRESET SETUP menu appears.
  - c. Select Default.
3. Reset the VNA by pressing the front panel **Preset Key**.

### Frequency and Set Power

4. On the right side menus, select MAIN MENU | Frequency. The FREQUENCY menu appears.
  - a. Observe that the displayed FREQUENCY menu.
  - b. Note that the Start and Stop values are the low-end and high-end frequencies.
5. At the top of the display, select MENU BAR | Channel | Averaging. The right side AVERAGING menu appears.
  - a. Click on the Averaging Factor button. On the displayed field toolbar, enter 40. Click the Enter button and then click the X at the end of the toolbar to close it.
  - b. Click on the Averaging toggle button and toggle to ON.

### Select Upper Left LCD Channel - TR1

6. Select the upper left LCD channel using the mouse by clicking on Tr1 S11 Refl Smith Imped.
  - The trace name has additional resolution and unit information appended to the displayed label.
7. At the top of the display, select MENU BAR | Trace | Display. The right side DISPLAY menu appears.
  - a. Click Trace Format button. The TRACE FORMAT menu appears.
  - b. Select Log Mag.
8. At the top of the display, select MENU BAR | Trace | Response.
  - a. The right side RESPONSE menu appears.
  - b. Click S21.
9. At the top of the display, select MENU BAR | Trace | Marker. The right side MARKERS [1] menu appears.
  - a. Click Marker Setup. The MARKER SETUP menu appears.
  - b. Toggle the Statistics Display button to ON.

10. At the top of the display, select MENU BAR | Trace | Display. The right-side DISPLAY menu appears.
  - a. Click on the View Trace button, the right-side VIEW TRACE menu appears.
  - b. After at least one complete forward and reverse sweep has occurred, select the Store Data to Memory button.
  - c. On the VIEW TRACE menu, the Data, Memory, Data & Memory, Data, Memory Math, and Off buttons become available.
  - d. Select the Data, Memory Math button.
11. At the top of the display, select MENU BAR | Trace | Scale. The right-side SCALE menu appears.
  - a. Click on the Resolution button. The Resolution field toolbar appears above the main display.
  - b. Enter 0.01 dB/Div.
  - c. Click the X to close the field toolbar.
  - d. After at least one complete forward and reverse sweep has occurred, view the trace statistics display titled Stat. Range: Entire Sweep.
  - e. Verify that the Std. Dev. measurement for this trace is less than 0.08 dB.

#### Select Upper Right LCD Channel - TR2

12. Select the upper right LCD channel using the mouse by clicking on Tr2 S12 Trans Log M+P.
  - The trace name has additional resolution and unit information appended to the displayed label.
13. At the top of the display, select MENU BAR | Trace | Display. The right side DISPLAY menu appears.
  - a. Click Trace Format button.
  - b. The TRACE FORMAT menu appears.
  - c. Select Log Mag.
14. At the top of the display, select MENU BAR | Trace | Response.
  - a. The right side RESPONSE menu appears.
  - b. Click S12.
15. At the top of the display, select MENU BAR | Trace | Marker. The right side MARKERS [1] menu appears.
  - a. Click Marker Setup. The MARKER SETUP menu appears.
  - b. Toggle the Statistics Display button to ON.
16. At the top of the display, select MENU BAR | Trace | Display. The right-side DISPLAY menu appears.
  - a. Click on the View Trace button, the right-side VIEW TRACE menu appears.
  - b. After at least one complete forward and reverse sweep has occurred, select the Store Data to Memory button.
  - c. On the VIEW TRACE menu, the Data, Memory, Data & Memory, Data, Memory Math, and Off buttons become available.
  - d. Select the Data, Memory Math button.
17. At the top of the display, select MENU BAR | Trace | Scale. The right-side SCALE menu appears.
  - a. Click on the Resolution button. The Resolution field toolbar appears above the main display.
  - b. Enter 0.1 dB/Div.
  - c. Click the X to close the field toolbar.
  - d. After at least one complete forward and reverse sweep has occurred, view the trace statistics display titled Stat. Range: Entire Sweep.
  - e. Verify that the Std. Dev. measurement for this trace is less than 0.008 dB.

**Select Lower Left LCD Channel - TR3**

18. Select the lower left LCD channel using the mouse by clicking on Tr3 S21 Trans LogM+P.
  - The trace name has additional resolution and unit information appended to the displayed label.
19. At the top of the display, select MENU BAR | Trace | Display. The right side DISPLAY menu appears.
  - a. Click Trace Format button. The TRACE FORMAT menu appears.
  - b. Select Phase.
20. At the top of the display, select MENU BAR | Trace | Response.
  - a. The right side RESPONSE menu appears.
  - b. Click S21.
21. At the top of the display, select MENU BAR | Trace | Marker. The right side MARKERS [1] menu appears.
  - a. Click Marker Setup. The MARKER SETUP menu appears.
  - b. Toggle the Statistics Display button to ON.
22. At the top of the display, select MENU BAR | Trace | Display. The right-side DISPLAY menu appears.
  - a. Click on the View Trace button, the right-side VIEW TRACE menu appears.
  - b. After at least one complete forward and reverse sweep has occurred, select the Store Data to Memory button.
  - c. On the VIEW TRACE menu, the Data, Memory, Data & Memory, Data, Memory Math, and Off buttons become available.
  - d. Select the Data, Memory Math button.
23. At the top of the display, select MENU BAR | Trace | Scale. The right-side SCALE menu appears.
  - a. Click on the Resolution button. The Resolution field toolbar appears above the main display.
  - b. Enter 0.1 ° (Deg) /Div.
  - c. Click the X to close the field toolbar.
  - d. After at least one complete forward and reverse sweep has occurred, view the trace statistics display titled Stat. Range: Entire Sweep.
  - e. Verify that the Std. Dev. measurement for this trace is less than 0.08 ° (Deg).

**Select Lower Right LCD Channel - TR4**

24. Select the lower right LCD channel using the mouse by clicking on Tr4 S22 Refl Smith Imped.
  - The trace name has additional resolution and unit information appended to the displayed label.
25. At the top of the display, select MENU BAR | Trace | Display. The right side DISPLAY menu appears.
  - a. Click Trace Format button. The TRACE FORMAT menu appears.
  - b. Select Phase.
26. At the top of the display, select MENU BAR | Trace | Response.
  - a. The right side RESPONSE menu appears.
  - b. Click S12.
27. At the top of the display, select MENU BAR | Trace | Marker. The right side MARKERS [1] menu appears.
  - a. Click Marker Setup. The MARKER SETUP menu appears.
  - b. Toggle the Statistics Display button to ON.
28. At the top of the display, select MENU BAR | Trace | Display. The right-side DISPLAY menu appears.
  - a. Click on the View Trace button, the right-side VIEW TRACE menu appears.

- b.** After at least one complete forward and reverse sweep has occurred, select the Store Data to Memory button.
  - c.** On the VIEW TRACE menu, the Data, Memory, Data & Memory, Data Memory Math, and Off buttons become available.
  - d.** Select the Data, Memory Math button.
- 29.** At the top of the display, select MENU BAR | Trace | Scale. The right-side SCALE menu appears.
  - a.** Click on the Resolution button. The Resolution field toolbar appears above the main display.
  - b.** In the toolbar, enter 0.1 °(Deg)/Div and then click the Enter button.
  - c.** Resolution is now set to 0.1 °(Deg)/Div in the stated Resolution.
  - d.** Click the X to close the field toolbar.
  - e.** After at least one complete forward and reverse sweep has occurred, view the trace statistics display titled Stat. Range: Entire Sweep.
  - f.** Verify that the Std. Dev. measurement for this trace is less than 0.08 °(Deg).

## B-7 System Noise Floor Test

### Overview

This test verifies that System Noise Floor performance will not significantly affect the accuracy of subsequent measurements. Measurement calibration of the system is not required for this test. This test requires that you press specified front panel keys, or use a mouse to make choices from the displayed menu(s). The key and menu selections used in this test are shown below. The test below is valid for all models and option combinations.

### Procedure

#### Connect Test Ports and Preset

1. Connect Test Ports 1 and 2 together using a high quality through line.
2. At the top of the display, select MENU BAR | Utilities | System. The right side SYSTEM menu appears.
  - a. Click on Setup. The SETUP menu appears.
  - b. Click on Preset Setup. The PRESET SETUP menu appears.
  - c. Select Default.
3. Reset the VNA using the front panel **Preset Key**.

#### Check Frequency and Set Power

4. At the top of the display, select MENU BAR | Channel | Frequency. The right side FREQUENCY menu appears.
  - a. Observe that the displayed FREQUENCY menu values.
  - b. Note that the Start and Stop values are the low-end and high-end frequencies.
5. At the top of the display, select MENU BAR | Channel | Averaging. The right side AVERAGING menu appears.
  - a. Click on the Averaging Factor button. On the displayed field toolbar, enter 40. Click the X at the end of the toolbar to close it.
  - b. Click on the Averaging button and toggle to ON.



### Check Frequency Sub-Bands

6. Repeat the steps below for only the frequency sub-bands that fall within the START and STOP limits of your system configuration.

**Table B-2.** Frequency Sub-Bands within Start and Stop System Limits

Sub-Band	Model Number Applicability	Start and Stop Frequency
<b>Band 1</b>	All instrument models.	0.07 MHz to 0.3 MHz
<b>Band 2</b>	All instrument models.	0.3 MHz to 2 MHz
<b>Band 3</b>	All instrument models.	0.3 MHz to 2 MHz
<b>Band 4</b>	All instrument models.	0.01 GHz to 2.5 GHz
<b>Band 5</b>	Depends on instrument model.	MS4642B: 2.5 GHz to 20 GHz MS4644B: 2.5 GHz to 40 GHz MS4645B: 2.5 GHz to 38 GHz MS4647B: 2.5 GHz to 38 GHz
<b>Band 6</b>	Applies only to MS4645B and MS4647B.	38 GHz to 50 GHz
<b>Band 7</b>	Applies only to MS4647B.	50 GHz to 65 GHz
<b>Band 8</b>	Applies only to MS4647B.	65 GHz to 67 GHz
<b>Band 9</b>	Applies only to MS4647B.	67 GHz to 70 GHz

### Set Channel

7. At the top of the display, select MENU BAR | Channel | Frequency.
  - a. The right side FREQUENCY menu appears.
  - b. Set the START and STOP frequencies for the sub-band to be verified.
8. At the top of the display, select MENU BAR | Channel | Power.
  - a. The right side POWER menu appears.
  - b. Click Port 1 Power, and on the field toolbar that appears, enter  $-10$  dBm.
9. At the top of the display, select MENU BAR | Channel | Averaging.
  - a. The right side AVERAGING menu appears.
  - b. Click and on the toolbar that appears, enter 10 Hz.

### Set Traces

10. At the top of the display, select MENU BAR | Trace | Trace Menu. The right side TRACE menu appears.
  - a. Click # of Traces button, and on the field toolbar that appears, enter 2.
  - b. Click on Trace Layout. The right side TRACE LAYOUT menu appears.
  - c. Select the 2 vertically stacked horizontal rectangle display configuration (third button from top).

**Select Upper Trace TR1**

11. Select the upper LCD channel by clicking on Tr1 S11 Refl Smith Imped.
  - The trace name has additional resolution and unit information appended to the displayed label.
12. At the top of the display, select MENU BAR | Trace | Display. The right side DISPLAY menu appears.
  - a. Click Trace Format button. The TRACE FORMAT menu appears.
  - b. Select Log Mag.
13. At the top of the display, select MENU BAR | Trace | Response.
  - a. The right side RESPONSE menu appears.
  - b. Click S21.
14. At the top of the display, select MENU BAR | Trace | Display.
  - a. The right-side DISPLAY menu appears.
  - b. Click on the View Trace button, the right-side VIEW TRACE menu appears.
  - c. After at least one complete forward and reverse sweep has occurred, select the Store Data to Memory button.
  - d. On the VIEW TRACE menu, the Data, Memory, Data & Memory, Data, Memory Math, and Off buttons become available.
  - e. Select the Data, Memory Math button.

**Select Lower Trace TR2**

15. Select the lower LCD channel by clicking on Tr2 S12 Trans Log M+P.
  - The trace name has additional resolution and unit information appended to the displayed label.
16. At the top of the display, select MENU BAR | Trace | Display.
  - a. The right side DISPLAY menu appears.
  - b. Click Trace Format button. The TRACE FORMAT menu appears.
  - c. Select Log Mag.
17. At the top of the display, select MENU BAR | Trace | Response.
  - a. The right side RESPONSE menu appears.
  - b. Click S12.
18. At the top of the display, select MENU BAR | Trace | Display.
  - a. The right-side DISPLAY menu appears.
  - b. Click on the View Trace button, the right-side VIEW TRACE menu appears.
  - c. After at least one complete forward and reverse sweep has occurred, select the Store Data to Memory button.
  - d. On the VIEW TRACE menu, the Data, Memory, Data & Memory, Data, Memory Math, and Off buttons become available.
  - e. Select the Data, Memory Math button.

**Reverse Terminations and Test Port Cable**

19. Disconnect the Test Port cable from Port 1.
20. Place terminations on Port 1 and the Test Port cable connected to Port 2.
21. At the top of the display, select MENU BAR | Channel | Averaging.
  - a. The right side AVERAGING menu appears.
  - b. Click and on the toolbar that appears, enter 1 (one) Hz.

**Select Upper Trace TR1**

22. Select the upper LCD channel by clicking on Tr1 S21 Trans Log M+P.
  - The trace name has additional resolution and unit information appended to the displayed label.
23. At the top of the display, select MENU BAR | Trace | Scale.
  - a. The right-side SCALE menu appears.
  - b. Click on the Reference Value button and, on the field toolbar that appears, enter  $-70$  dB.
  - c. Click on the Reference Position button and, on the field toolbar that appears, enter 8.
24. At the top of the display, select MENU BAR | Trace | Display.
  - a. The right side DISPLAY menu appears.
  - b. Click the Trace Limit Lines button. The LIMIT menu appears.
  - c. Click on Limit Line and toggle to ON.
  - d. Click on the Edit Limit Line button. The EDIT LIMIT LINE menu appears on the right, and the LIMIT LINE TABLEAU appears at the bottom of the screen.
  - e. Click the Add button and use the table below to enter limit-line data for the sub-band.

**Table B-3.** Sub-Band Limit Line Data - X Offset and Y Offset Remain Blank

Sub-Band	X1 to X2	Standard VNAs Y1 and Y2	VNAs with Option 51 Y1 and Y2	VNAs with Option 6x Y1 and Y2
<b>Band 1</b>	0.07 MHz to 0.3 MHz	$-65$ dB	$-64$ dB	$-63$ dB
<b>Band 2</b>	0.3 MHz to 2 MHz	$-82$ dB	$-81$ dB	$-80$ dB
<b>Band 3</b>	2 MHz to 10 MHz	$-95$ dB	$-94$ dB	$-93$ dB
<b>Band 4</b>	0.01 GHz to 2.5 GHz	$-100$ dB	$-98$ dB	$-94$ dB
<b>Band 5</b>	Depends on the instrument model: <ul style="list-style-type: none"> <li>• MS4642B: 2.5 to 20 GHz</li> <li>• MS4644B: 2.5 to 40 GHz</li> <li>• MS4645B: 2.5 to 38 GHz</li> <li>• MS4647B: 2.5 to 38 GHz</li> </ul>	$-100$ dB	$-97$ dB	$-93$ dB
<b>Band 6</b>	Applies only to MS4645B and MS4647B: <ul style="list-style-type: none"> <li>• 38 GHz to 50 GHz</li> </ul>	$-100$ dB	$-96$ dB	$-93$ dB
<b>Band 7</b>	Applies only to MS4647B: <ul style="list-style-type: none"> <li>• 50 GHz to 65 GHz</li> </ul>	$-97$ dB	$-93$ dB	$-91$ dB
<b>Band 8</b>	Applies only to MS4647B: <ul style="list-style-type: none"> <li>• 65 GHz to 67 GHz</li> </ul>	$-95$ dB	$-90$ dB	$-86$ dB
<b>Band 9</b>	Applies only to MS4647B: <ul style="list-style-type: none"> <li>• 67 GHz to 70 GHz</li> </ul>	$-93$ dB	$-87$ dB	$-84$ dB

25. When all sub-band data is entered, at the bottom of the right side menu, click Back to return to the LIMIT menu.
26. After at least one complete forward and reverse sweep has occurred, verify that trace data is below the limit line.

**Select Lower Trace (TR2)**

27. Select the lower LCD channel by clicking on Tr2 S12 Trans Log M+P.
  - The trace name has additional resolution and unit information appended to the displayed label.
28. At the top of the display, select MENU BAR | Trace | Scale.
  - a. The right-side SCALE menu appears.
  - b. Click on the Reference Value button and, on the field toolbar that appears, enter –70 dB.
  - c. Click on the Reference Position button and, on the field toolbar that appears, enter 8.
29. At the top of the display, select MENU BAR | Trace | Display.
  - a. The right side DISPLAY menu appears.
  - b. Click the Trace Limit Lines button. The LIMIT menu appears.
  - c. Click on Limit Line and toggle to ON.
  - d. Click on the Edit Limit Line button. The EDIT LIMIT LINE menu appears on the right, and the LIMIT LINE TABLEAU appears at the bottom of the screen.
30. Click the Add button and use the table below to enter limit line data for the sub-band:

**Table B-4.** Sub-Band Limit Line Data - X Offset and Y Offset Remain Blank

Sub-Band	X1 to X2	Standard Y1 and Y2	Option 51 Y1 and Y2	Option 6x Y1 and Y2
<b>Band 1</b>	0.07 MHz to 0.3 MHz	–65 dB	–64 dB	–63 dB
<b>Band 2</b>	0.3 MHz to 2 MHz	–82 dB	–81 dB	–80 dB
<b>Band 3</b>	2 MHz to 10 MHz	–95 dB	–94 dB	–93 dB
<b>Band 4</b>	0.01 GHz to 2.5 GHz	–100 dB	–98 dB	–94 dB
<b>Band 5</b>	<ul style="list-style-type: none"> <li>• MS4642B: 2.5 GHz to 20 GHz</li> <li>• MS4644B: 2.5 GHz to 40 GHz</li> <li>• MS4647B: 2.5 GHz to 38 GHz</li> </ul>	–100 dB	–97 dB	–93 dB
<b>Band 6</b>	Applies only to MS4645B and MS4645B: <ul style="list-style-type: none"> <li>• 38 GHz to 50 GHz</li> </ul>	–100 dB	–96 dB	–93 dB
<b>Band 7</b>	Applies only to MS4647B: <ul style="list-style-type: none"> <li>• 50 GHz to 65 GHz</li> </ul>	–97 dB	–93 dB	–91 dB
<b>Band 8</b>	Applies only to MS4647B: <ul style="list-style-type: none"> <li>• 65 GHz to 67 GHz</li> </ul>	–95 dB	–90 dB	–86 dB
<b>Band 9</b>	Applies only to MS4647B: <ul style="list-style-type: none"> <li>• 67 GHz to 70 GHz</li> </ul>	–93 dB	–87 dB	–84 dB

31. When all sub-band data is entered, at the bottom of the right side menu, click **Back** to return to the LIMIT menu.
32. After at least one complete forward and reverse sweep has occurred, verify that trace data is below the limit line.

**Repeat for Each Sub-Band**

33. Return to section [“Check Frequency Sub-Bands” on page B-14](#) above and repeat Step 6 through Step 32 for the next sub-band.



# Appendix C — Security and Maintenance

## C-1 Information Security

### Storage and Memory Overview

Considering secure environments, the internal memories of the VectorStar MS464xB Series VNA uses DRAM (Dynamic Random Access Memory) in its CPU board and Flash Memory in its DSP (Digital Signal Processing) board. The internal storage drive is an easily removable SATA Solid State Drive (SSD).

#### DRAM

Information stored in DRAM and used by the VectorStar CPU is temporary; this data is lost when the VectorStar is powered off.

#### Flash Memory

Flash Memory is used to save instrument factory calibrations and settings. No user application information is stored in Flash Memory and the memory space is not user-accessible. Since this memory space is not used by the user, nor by the instrument to store user application settings, it does not require cleansing after it has entered a secure location.

#### Solid State Drive (SSD)

The Solid State Drive (SSD) persistently stores instrument-dependent configuration data and measurements including instrument saved setups, custom presets, last used setups, and similar information.

#### Enhancing Information Security

For secure applications and locations, the removable solid-state drive (SSD) can be easily and quickly removed from the instrument chassis and left in the secure location. The VectorStar chassis can then be transferred to another location.

The **Option 4 Additional Solid State Drive** contains the same operating system and software applications as the SSD shipped with the VectorStar instrument. It allows the instrument chassis be functional again as a VNA in another location, either in a non-secure environment or in a second secure environment. Multiple Option 4 SSDs can therefore be used to support multiple locations.

#### Note

Only insert or remove the SSD when the VNA is completely powered down. See [Section C-3 “Installing and Configuring an Additional Solid State Drive”](#) for instructions.

Also, the SSD includes unique instrument dependent configuration data so it cannot be transferred to a different instrument chassis.

## C-2 Operating System Restore

The VectorStar VNA is configured with Windows® Operating System Restore. This system can be accessed from the Windows desktop Start menu and used to restore the VectorStar operating system to a recent known good state.

The instrument is shipped with a “Point of Shipment” restore point. Additional restore points are created when the VectorStar application is updated, other user applications are installed, when new or updated hardware drivers are installed, or when restore points are created manually. Restore points are saved for a limited time, so the system should be restored as soon as problems are discovered.

<b>Note</b>	For detailed information about system restore and additional restore tasks, refer to the Windows Operating System Help and Support as detailed in the procedure below.
-------------	--

In the event that the VectorStar operating system or application becomes corrupt or inoperable, the instrument must be returned to a qualified service center for repair.

<b>Caution</b>	<p>If a VectorStar VNA internal drive restore is required, contact Anritsu Customer Service.</p> <p>Restoring the system software may adversely affect some user data or programs that are loaded onto the internal drive. The instrument operating system will be configured as it was on the selected restore date, including the original option configuration. Before starting the system restore procedure, back up all user data, applications, and ensure that the installation files of any additional software or instrument options are available for reinstallation.</p>
----------------	---

### Procedure

The following procedure should be performed with a mouse attached to the instrument.

1. Close the VectorStar application and reveal the operating system desktop by clicking:

**File** | Exit

2. To access the Operating System Help and Support for additional information on System Restore, move the mouse pointer to the bottom of the desktop to reveal the Windows Task Bar and click:

**Start** | Help and Support

Search for topics on “System Restore.”

3. Open System Restore by moving the mouse pointer to the bottom of the desktop to reveal the Windows Task Bar and clicking:

**Start** | Programs | Accessories | System Tools | System Restore

4. If you are prompted for an administrator password or confirmation, enter the password or provide confirmation.
5. Follow the on-screen instructions to restore your computer to an earlier restore point shown on the calendar. The most recent known good restore point should be used to restore the instrument operating system.
6. Do not interrupt the restoration process once it has been started.

## C-3 Installing and Configuring an Additional Solid State Drive

The **MS464xB-004 Additional Solid State Drive (SSD)** provides the capability of using a different SSD for different measurement tasks, and then to be able to quickly remove the measurement data and store it a secure location. A separate SSD can be quickly installed in instrument, freeing it for other tasks or to accompany the instrument back to the factory for recalibration.

<b>Note</b>	Using multiple removable SSDs makes the VectorStar VNAs ideal for secure environments. The SSD can be left in the secure environment, and the instrument chassis moved to a different location where another SSD can be installed, maintaining instrument usage. The internal memories of the instrument retain no user data after the SSD has been removed.
-------------	--

The **MS464xB-004 SSD** is factory-configured to the same specification as the instrument's original internal drive. Both drives provide the factory as-shipped instrument configuration, setup, and calibration information. To use the additional SSD, the general process is to copy any user setup, data, and calibration files from the original SSD to the optional SSD while outside the secure environment. Then, when configured, move the SSD into the secure environment.

### Procedure

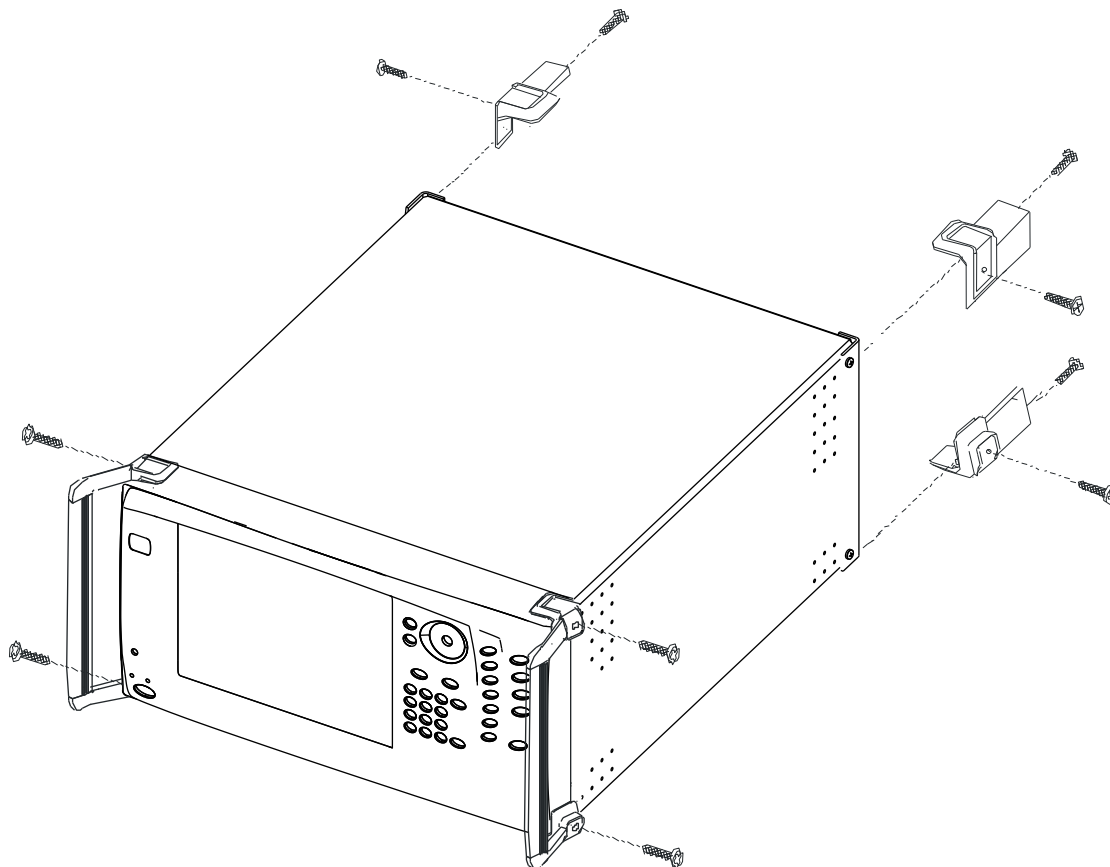
1. Prior to the internal drive replacement, copy and save any user setup, data, or calibration files to a USB Memory Device.
2. Make sure also that the following hardware calibrations are copied from the C:\AnritsuVNA\Data folder:
  - AlcCal.alc
  - AllHWCal.ahc
  - AnalogInCal.alc
  - LOCal.slc
  - SqmPowerCal.sqm
  - tenMHzCal.tmc
3. When all files are copied, power down the instrument and turn it off.
  - If the instrument is in the Operate mode (the green **Operate LED** is on), from the front panel, press and hold the left side **Standby/Operate key** for at least one (1) second.
  - The green **Operate LED** turns off and the orange **Standby LED** turns on, indicating the instrument is in Standby mode.
  - From the rear panel, use the **AC Power Rocker Switch** to turn the instrument off by pressing the "O" side of the rocker switch.
4. On the **Rear Panel**, loosen the two captive screws anchoring the **SSD** in place.
5. Remove the original **SSD**, insert into an anti-static bag or container, and store in a safe place.
6. Slide in the replacement **SSD**. You will feel a slight resistance the last few millimeters as the connector seats. Do not force. Tighten the captive screws evenly on both sides of the drive.
7. Power up the system and it should boot as before the change.
  - From the rear panel, use the **AC Power Rocker Switch** to turn the instrument on by pressing the "I" side of the rocker switch.
  - The orange **Standby LED** turns on, indicating the instrument is in Standby mode. When the orange Standby LED is on steady and not blinking, from the front panel, press and hold the left side **Standby/Operate key** for at least one (1) second.
  - The orange **Standby LED** turns off and the green **Operate LED** turns on, indicating the instrument is in Operate mode.



## C-4 Optional Rack Mount Installation

Instruments that are ordered from the factory with a rack mount option arrive with the rack mount hardware pre-installed. Alternatively, the rack mount option may be ordered at a later time and installed whenever required by the user. The general procedure to install the rack mount kit is described below:

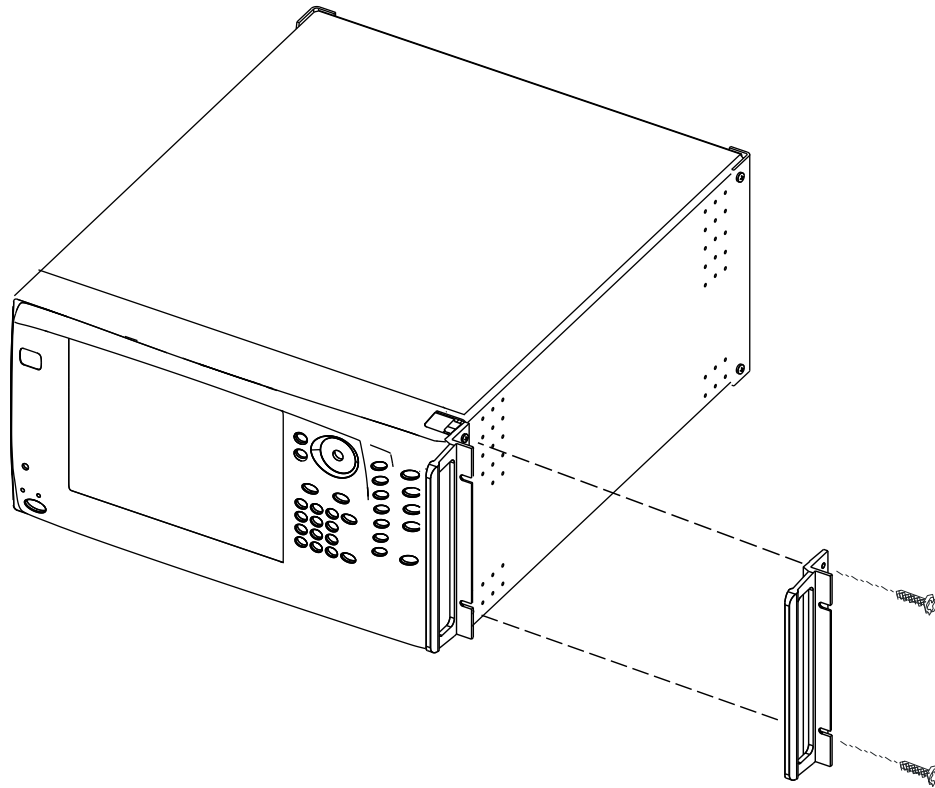
1. Disconnect the line cord and any other attachments from the instrument.
2. Carefully place the instrument on a secure and stable work surface.
3. Using a Phillips screwdriver, remove the two front panel handles and the four feet at the rear of the instrument (see [Figure C-1](#)). These screws will not be reused.



**Figure C-1.** Removing Instrument Handles and Feet for Rack Mount

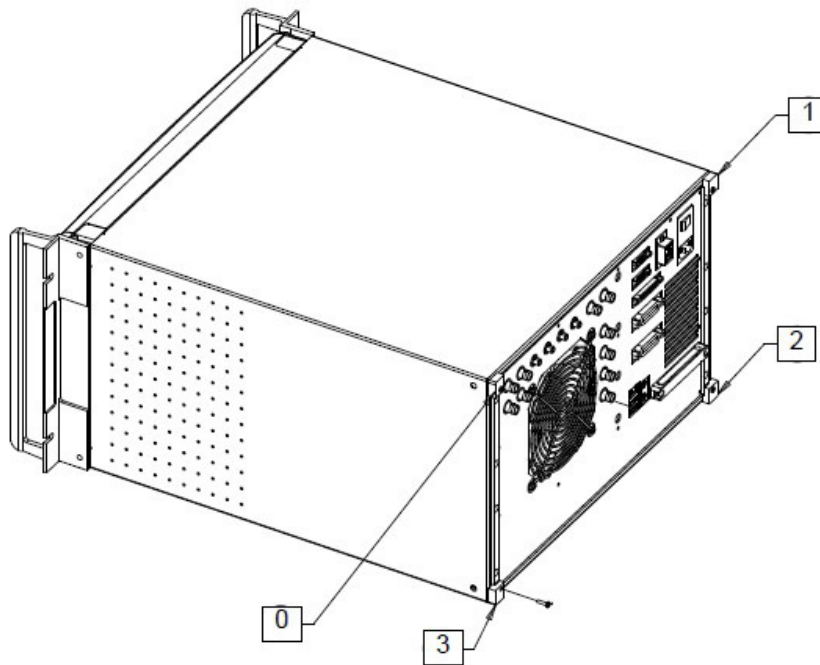
**Note** The rack installation figures are for generic instruments and may differ in general appearance.

4. Install the rack mount bracket onto the instrument sides using the green-headed screws supplied with the kit (see [Figure C-2](#)).



**Figure C-2.** Attaching Rack Mount Ears to Instrument

5. Install the machined corners onto the rear of the instrument using the hardware provided in the kit, referencing the number machined on each part. (See [Figure C-3](#))



**Figure C-3.** Attaching the Machined Corners to Instrument

6. This completes the installation of the rack mount handles.

## C-5 Fuse Maintenance

The VectorStar MS464xB Series VNA requires periodic cleaning of the cooling fan screen to prevent an obstruction that could cause overheating. Additional maintenance that may be required includes replacing a blown fuse, replacing the CPU backup battery, and cleaning the LCD panel.

### Fuse Summary

The MS464xB contains six (6) fuses, four (4) external and two (2) internal.

#### External Fuses

There are two sets of rear panel fuses available for field replacement.

- **AC Power Input Fuses**

Two fuses located inside the IEC C14 AC Power Entry Module connector rated at T 6.3 A, 250 V.

- **Bias Input Fuses**

Two fuses, one per port, located inside the twist-off fuse holders rated at F 0.5 A, 250 V, quick acting.

#### Internal Fuses

Internal fuses are **not** replaceable in the field. They are mounted within the field-replaceable power supply module. Internal fuse information is provided for reference only.

- **Internal Fuse #1**

Rated at 6.3 A, 250 V, F (quick acting)

- **Internal Fuse #2**

Rated at 15 A, 32 VDC (automotive type).

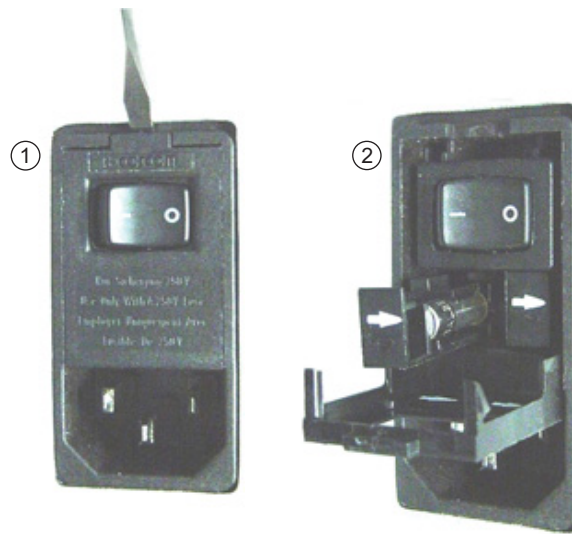
### External Rear Panel AC Input Fuses

The AC line fuses used in the VectorStar MS464xB Series VNA are 6.3A, type T fuses. The line fuse values are printed on the rear panel next to the power connector. Always use a new fuse of the type and rating specified by the fuse markings on the rear panel of the instrument. To replace the line fuses, refer to [Figure C-4](#) and follow the procedure steps below.

<b>Danger</b>	Before changing the fuse, always remove the power cord from the power outlet. There is the risk of receiving a fatal electric shock if the fuse is replaced with the power cord connected.
---------------	--

1. Set the VectorStar MS464xB Series VNA to standby mode using the front panel **Power** button, and, at the back panel, turn the instrument off by using the AC Power Entry Module **On/Off** switch.
2. Disconnect the power cord from the rear panel power receptacle.
3. Using a small flat-blade screwdriver, carefully pry under the tab next to the rear panel power receptacle to open the fuse block cover and gain access to the fuse holder.
4. Slide out the fuse holder.
5. Replace the fuse in the fuse holder.
6. Install the fuse holder back into the rear panel fuse block.

- Close the cover to secure the fuse holder in place. The cover will close with an audible snap.



- |  |                                      |
|--|--------------------------------------|
| 1. Opening the Rear Panel Fuse Holder with a flat blade screwdriver. | 2. Sliding out and replacing a fuse. |
|--|--------------------------------------|

**Figure C-4.** Replacing the Rear Panel Fuse

- Reconnect the analyzer to the power source and turn the back panel **On/Off** switch to on.
- At the front panel, set the VectorStar MS464xB Series VNA to operate using the front panel **Power** button.

## Bias Fuse Replacement

The required replacement Bias Port fuses used in the VectorStar MS464xB Series VNA are printed on the rear panel below the **Bias Port Fuse Holders**. Always use a new fuse of the type and rating specified by the fuse markings on the rear panel of the instrument. To replace the bias fuses, follow the procedure steps below.

### Danger

Before changing the fuse, always remove the power cord from the power outlet. There is the risk of receiving a fatal electric shock if the fuse is replaced with the power cord connected.

- Set the VectorStar MS464xB Series VNA to standby mode using the front panel **Power** button, and, at the back panel, turn the instrument off by using the **AC Power Entry Module On/Off** switch.
- Disconnect the power cord from the rear panel power receptacle.
- Remove any DC biasing from the **DC Bias Inputs**.
- Using a small flat-blade screwdriver, unscrew the each **Bias Fuse Holder**.
- Slide out fuse holder.
- Remove the fuse.
- Replace the fuse in the fuse holder.
- Install the fuse holder back into the rear panel fuse block.
- Lightly tighten the fuse holder with the flat-blade screwdriver.
- Reconnect the analyzer to the power source and turn the back panel **On/Off** switch to on.

At the front panel, set the VNA to operate using the front panel **Power** button.

## C-6 Preparation for Storage or Shipment

Use the following information for preparing the VectorStar MS464xB Series VNA for storage or shipment.

### Preparation for Storage

Preparing the VNA for storage consists of cleaning the unit, packing it inside of the storage container with moisture-absorbing desiccant crystals, and storing the unit in a temperature-controlled environment that is maintained between  $-40\text{ }^{\circ}\text{C}$  and  $+75\text{ }^{\circ}\text{C}$ .

### Preparation for Shipment

To provide maximum protection against damage in transit, the VNA should be repackaged in the original shipping container or transit case. If these containers are not available and the unit is being returned to Anritsu for repair, advise Anritsu Customer Service. In the event these options are not possible, instructions for packaging and shipment are given below:

#### Remove Attached Equipment and Connectors

1. Remove any user-supplied connectors or adapters. If installed, remove the rack mounting ears and related hardware.

#### Use a Suitable Container

2. Obtain a corrugated cardboard carton with at least 125 kg test strength. This carton should have inside dimensions of no less than 15 cm (6.0") larger than the instrument unit dimensions to allow for cushioning.

#### Dimensions

3. The instrument dimensions are:
  - **Height:** 267 mm body height (10.5") - 286 mm between feet outer edges (11.3")
  - **Width:** 426 mm body height (16.7") - 457 mm between feet outer edges (17.9"), 487 mm between front panel handle outer edges (19.2")
  - **Depth:** 502 mm body depth (16.7") - 591 mm between handle and foot outer edges (23.3")

#### Protect the Instrument

4. Surround the unit with polyethylene sheeting to protect the finish. A sealed bag is recommended as a best practice.

#### Cushion the Instrument

5. Cushion the instrument on all sides by tightly packing dunnage or urethane foam between the carton and the unit. Provide at least 8 cm (3.0") of dunnage on all sides; best practices recommend completely filling the space between the carton and instrument with dunnage.

#### Seal the Container

6. Seal the carton by using either shipping tape or an industrial stapler.

#### Address the Container

7. If the instrument is being returned to Anritsu for service, mark the address of the appropriate Anritsu service center and your return address on the carton in one or more prominent locations.

Contact information for all worldwide Anritsu Service Centers is available on the Web site at:

<http://www.anritsu.com/Contact.asp>



# Appendix D — Terms and Abbreviations

## Glossary

### D-1 Appendix Overview

This glossary defines the terms and abbreviations that appear on the connectors, hard keys, menus, and buttons of the MS464xB Series VNA. In some cases, due to space limitations, multiple abbreviations are used for the same term or the same abbreviation is used with different punctuation.

### D-2 Glossary

Abbreviation or Term	Meaning / Definition (1 of 16)
%	Percentage
#	Number
(1:2):3	One differential pair and one singleton. Trace and dialog labeling for Mixed-mode with one differential pair and one singleton. In this example, The DUT port differential is measured from 1 to 2 and 3 is the singleton.
(1:2):3:4	One differential pair and two singletons. Trace and dialog labeling for Mixed-mode with one differential pair and two singletons. In this example, the DUT port differential is measured from 1 to 2 while 3 and 4 are the singletons.
(4:1):(2:3)	Two differential pairs. Trace and dialog labeling for Mixed-mode with two differential pairs. In this example, the first port pair is measured from 4 to 1 and the second port pair is measured from 2 to 3.
(4:2):1	One differential pair and one singleton. Trace and dialog labeling for Mixed-mode with one differential pair and one singleton. The DUT port differential is measured from 4 to 2 and 1 is the singleton.
(4:2):1:3	One differential pair and two singletons. Trace and dialog labeling for Mixed-mode with one differential pair and two singletons. In this example, the DUT port differential is measured from 4 to 2 while 1 and 3 are the singletons.
(1:2):(3:4)	Two differential pairs. Trace and dialog labeling for Mixed-mode with two differential pairs. In this example, the first port pair is measured from 1 to 2 and the second port pair is measured from 3 to 4.
1P2PF	Abbreviation for one-path two-port calibration forward direction.  Used in the SCPI command :SENSe{1-16}:CORRection:COLLect[:METHod]:1P2PF to simulate the calibration.
1P2PR	Abbreviation for one-path two-port calibration reverse direction.  Used in the SCPI command :SENSe{1-16}:CORRection:COLLect[:METHod]:1P2PR to simulate the calibration.
A1 a1	Reference 1 or Reference a.



Abbreviation or Term	Meaning / Definition (2 of 16)
A2 a2	Reference 2 or Reference a.
Actv.	Active.
Addr.	Address.
ALC	Automatic Level Control.
ALRM A-LRM™	Calibration menu. Advanced-Line-Reflect-Match calibration algorithm and method. A-LRM is a trademark of Anritsu Company.
Asym.	Product asymmetry or the difference in amplitude of the upper vs. the lower product of a given order. Used in IMD measurements.
AutoCal™	Automatic calibrator module. Automatic Calibration Routine. AutoCal is a trademark of Anritsu Company.
Auto-Return Auto-return	User interface. After a button selection, the instrument automatically returns to previous menu where the user selection is usually displayed on a field button. Auto-return buttons are usually a member of a button selection group (“a radio button” group).
Avg.	Average.
B1 b1	S-Parameter. Test 1 or Test b.
B2 b2	S-Parameter. Test 2 or Test b.
Bal.	Balance.
BB	Broadband.
BeginningSwp	Beginning sweep.
Button Selection Group	Popular name is “radio button” group. A group of two or more soft buttons where selection of one button de-selects all other button members of the group. Often combined with auto-return function (described above) where the interface automatically returns to previous menu after the button selection is made.
Button Buttons	Individual elements of the right-side user interface menus. Button come in a variety of types such as toggle buttons, or menu buttons. See also “ <a href="#">Soft buttons.</a> ” Compare with “ <a href="#">Hard keys, keys.</a> ”
C(P) C(S) C(S)-L(P) C(P)-L(S)	Abbreviation for LC circuit primitives. Capacitance (Parallel), Capacitance (S), Capacitance (Series)-Inductor (Parallel), and Capacitance (Parallel)-Inductor (Series).
CAL (.CAL) File	File type extension.
Cal. Eff. Pwr	Calculated effective power.
Cal Cal.	Calibrate. Calibration.
Cals Cals.	Calibrations.
CCKTFour	A four-node capacitance C circuit. Port assignments are defined in separate commands. Available if the instrument is in 4-Port VNA mode.
Charac.	Characterize, Characterization.

Abbreviation or Term	Meaning / Definition (3 of 16)
Ch Chan.	Channel, Channels.
cm	Distance units abbreviation. Centimeter.
Cnt	Count.
Coax	Coaxial cable.
Coef.	Coefficient.
Combiner	Any of various devices used to combine different RF signals while maintaining some level of return loss (usually). Among other purposes, used to combine the two input tones for an IMD measurement. An internal combiner is part of Option 32.
Comm.	Communication.
Compress	Compression.
Config.	Configure, Configuration.
CPLS	Parallel capacitance with series inductance. Available if the instrument is in 2-Port VNA mode.
CSLP	Series capacitance with parallel inductance. For capacitance only, set L to zero. Available if the instrument is in 2-Port VNA mode.
CW	Continuous Wave.
D1S0	D One S Zero. In 4-Port VNAs, one differential pair and no singletons. Used in the MXP SETUP dialog box and the :CALCulate{1-16}:MXP SCPI commands. <ul style="list-style-type: none"> <li>MAIN   System   SYSTEM   Setup   SETUP   Misc. Setup   MISC. SETUP   MnP Files Setup   MXP SETUP Dialog Box</li> </ul>
D1S1	D One S One. In 4-Port VNAs, one differential pair and one singleton. Used in the MXP SETUP dialog box and the :CALCulate{1-16}:MXP SCPI commands. <ul style="list-style-type: none"> <li>MAIN   System   SYSTEM   Setup   SETUP   Misc. Setup   MISC. SETUP   MnP Files Setup   MXP SETUP Dialog Box</li> </ul>
D1S2	D One S Two. In 4-Port VNAs, one differential pair and two singletons. Used in the MXP SETUP dialog box and the :CALCulate{1-16}:MXP SCPI commands. <ul style="list-style-type: none"> <li>MAIN   System   SYSTEM   Setup   SETUP   Misc. Setup   MISC. SETUP   MnP Files Setup   MXP SETUP Dialog Box</li> </ul>
D2S0	D Two S Zero. In 4-Port VNAs, two differential pairs and no singletons. Used in the MXP SETUP dialog box and the :CALCulate{1-16}:MXP SCPI commands. <ul style="list-style-type: none"> <li>MAIN   System   SYSTEM   Setup   SETUP   Misc. Setup   MISC. SETUP   MnP Files Setup   MXP SETUP Dialog Box</li> </ul>
DAC	Digital to Analog Converter.
Data/Mem	Data value divided by the memory value.
Data+Mem	Data value plus the memory value.
DataMem	Data value times the memory value.
Data-Mem	Data value minus the memory value.
DataMemMath	Data and memory mathematical equations.

Abbreviation or Term	Meaning / Definition (4 of 16)
dB	Decibels.
dB/Div	SCALE menu toolbar function. Decibels per trace display division.
DDS	Direct Digital Synthesis.
De-embed De-Embed Deembed	De-embedding. Process where calibration parameters for a test fixture are removed from the calibrated instrument and connection cables.
Deg Degs	Degree, Degrees.
Degs/Div	SCALE menu toolbar function. Degrees per trace display division. For circular Polar or Smith Chart displays only.
Delta	The spacing between main tones. In other literature, it is sometimes called the 'offset' or 'tone spacing'. Used in IMD measurements.
Diff.	Differential.
DifferentialView™	Anritsu Company trademarked application for True Mode Stimulus (TMS) analysis.
Div.	Division.
DTF	Distance to fault.
DUT	Device under test.
E/DE EDE Embed Embedding	Embedding/De-Embedding. Process where known calibration parameters for a test fixture are added to the instrument calibration consisting of just the instrument and connection cables.
EMC	Electromagnetic Compatibility.
EO E/O	Electrical-to-Optical Refers to fiber optic modulators (sometimes integrated with lasers) and the measurement of such devices.
EQN	Equation.
Ext.	External.
Ext. Src. Addr.	External source address.
Extrap	Extrapolation.
$f_c$	Center frequency: In IMD measurements, refers to the frequency half-way between the two main tones.
Fctry	Factory.
Field Toolbar	When some buttons are selected, the field toolbar that appears near the top of the screen display just below the icon toolbar. The toolbar provides user control to select the value of the required input such as a frequency, attenuation level, or device address. Some toolbar fields allow the selection of units; for example, frequency field toolbars allow selection of Hz, kHz, MHz, or GHz units. Some field toolbars appear at the bottom of the display area when editing table information such as for Segmented Sweep operations.
Flash drive	See <a href="#">USB Memory Device</a> .
Freq-Base	Frequency-Based.
Freq Freq.	Frequency.
FreqIniTable.ini	File type.

Abbreviation or Term	Meaning / Definition (5 of 16)
FreqTable.mft	File type.
Full 2-port Full Two port	Calibration method. Also called “12 Term Calibration.”
FULL1	Abbreviation for full one port calibration. Used in the SCPI command :SENSe{1-16}:CORRection:COLLect[:METHod]:FULL1 to simulate the calibration.
FULL2	Abbreviation for full two port calibration. Used in the SCPI command :SENSe{1-16}:CORRection:COLLect[:METHod]:FULL2 to simulate the calibration.
FULLB	Abbreviation for full one port reflection calibration both ports. Used in the SCPI command :SENSe{1-16}:CORRection:COLLect[:METHod]:FULLB to simulate the calibration.
GHz	Gigahertz. 10E9 Hertz.
GPIB	IEEE-488.2 General Purpose Interface Bus. GPIB Command.
GUI	Graphical User Interface.
Hard keys, keys	Physical front panel keys or physical buttons on the MS464xB VNA. In text, keys are identified with a distinctive font such as the <b>Preset Key</b> . Compare with “soft buttons”.
HDD	Hard Disk Drive.
Het.	Heterodyne.
ID	Identification number.
IEC	International Electrotechnical Commission.
IEEE	Institute of Electrical and Electronics Engineers.
IEEE-488.2	IEEE Specification 488.2 for General Purpose Interface Bus (GPIB).
IF	Intermediate Frequency.
IFBW	Intermediate Frequency Bandwidth.
IIPn	Input referred N <sup>th</sup> order intercept point. Used in IMD measurements.
Imag.	Imaginary.
IMD	Intermodulation distortion.
IMDView™	Anritsu Company trademarked application for measuring IMD (Intermodulation Distortion).
Imped.	Impedance.
Imped. Transf.	Impedance transformation.
Indep.	Independent.
Inter.	Interface, Interference.
IntraTrace	Mathematical operations within the same trace display. As opposed to inter-trace operations.
IP	Internet Protocol.
IPn	N <sup>th</sup> order intercept point. Calculated point in power where the main tone power and Nth order IMD product are equal based on linear (of dB quantities) extrapolation.
j	Imaginary number.

Abbreviation or Term	Meaning / Definition (6 of 16)
jX	Reactance term in Ohms.
K Connector™	Connector type. Compatible with SMA, WSM and 3.5 mm connectors, it has a rated frequency range from DC to 40 GHz. K Connector is a trademark of Anritsu Company.
key	See “ <a href="#">Hard keys, keys</a> ”.
kHz	Kilohertz. 10E3 Hertz.
km	Distance units abbreviation. Kilometer.
L(P) L(S) L(P)-C(S) L(S)-C(P)	Abbreviation for LC circuit primitives. Inductor (Parallel), Inductor (Series), Inductor (Series)-Capacitance (Parallel), and Inductor (Parallel) and Capacitance (Series).
Lang.	Language.
LCD	Liquid Crystal Display.
LCKTFour	A four-node inductance L circuit. Port assignments are defined in separate commands. Available if the instrument is in 4-Port VNA mode.
Lft	Left.
Lin	Linear.
LO	Local Oscillator.
Log	Logarithmic.
LogMag	Logarithmic Magnitude.
LRL/LRM	Calibration method. Line-reflect-line calibration algorithm. Line-reflect-match calibration algorithm.
LSCP	Series inductance with parallel capacitance. For inductance only, set C to zero. Available if the instrument is in 2-Port VNA mode.
LSCS	Parallel inductance with series capacitance. Available if the instrument is in 2-Port VNA mode.
LVD	Low Voltage Directive.
m	Distance unit abbreviation. Meter.
Mag Mag.	Magnitude.
max Num	Maximum Number.
Max max	Maximum.
MB/s	Megabytes per second.
Mb Mbit	Megabit. 1 megabit equals 10E6 bits or 1,000,000 bits.
MB Mbyte	Megabyte. In SI decimal units, 1 megabyte equals 1000E3 bytes or 1,000,000 bytes. In IEC binary units, a “mebibyte or Mi” equals 1024E3 bytes or 1,048,576 bytes, but is also commonly called a “megabyte.”
Mem Mem.	Memory.
Memory stick	See <a href="#">USB Memory Device</a> .
menu	Available menus in the top level menu-bar command interface.

Abbreviation or Term	Meaning / Definition (7 of 16)
Menu command	Individual commands listed on a drop-down menu from the top menu bar. For example, on the File menu, the first command is Recall.
MFT (.mft) Files	File type extension.
MG	Anritsu Measurement Guide.
MHz	Megahertz. 10E6 Hertz. 1,000,000 Hertz.
Micr.	Microporous Teflon dielectric type.
Min Min.	Minimum.
Misc.	Miscellaneous.
Mkr # [OFF]	Marker number with the Reference Marker function toggled off and the marker also toggled off; for example, Mkr 1 [OFF] for Marker 1.
Mkr # [ON]	Marker number with the Reference Marker function toggled off and the marker toggled on; for example, Mkr 1 [ON] for Marker 1.
Mkr#-Ref [OFF]	Marker number with the Reference Marker function toggled on and the marker toggled off; for example, Mkr1-Ref [OFF] for Marker 1.
Mkr#-Ref [ON]	Marker number with the Reference Marker function toggled on and the marker also toggled on; for example, Mkr1-Ref [ON] for Marker 1.
Mkr Mkrs	Marker, Markers.
mm	Units abbreviation. Millimeter.
MM	Anritsu Maintenance Manual.
mmWave mm-Wave	Millimeter wave (usually used to denote a frequency range of operation higher than that of the basic MS464xx)
Model#	Model Number.
ms	Time units abbreviation. Millisecond.
MS464xB Series VNA	The function or feature refers to any of the MS464xB VNA models: MS4642B, MS4644B, MS4645B, and the MS4647B VNAs.
MS4642B VNA	VNA Model MS4642B, 10 MHz to 20 GHz, K connectors. With Low Frequency Extension option, lower frequency limit is 70 kHz.
MS4644B VNA	VNA Model MS4644B, 10 MHz to 40 GHz, K connectors. With Low Frequency Extension option, lower frequency limit is 70 kHz.
MS4645B VNA	VNA Model MS4645B, 10 MHz to 50 GHz, V Connectors. With Low Frequency Extension option, lower frequency limit is 70 kHz.
MS4647B VNA	VNA Model MS4647B, 10 MHz to 70 GHz, V connectors. With Low Frequency Extension option, lower frequency limit is 70 kHz.
Navigation paths	Navigation to a menu or dialog box of interest is entered using navigation notation where the pipe (“   ”) symbol is used to separate elements. The starting menu is usually the MAIN Menu. The general format is with menu and dialog boxes in ALL CAPS and buttons in Title Case; both use this distinctive Sans Serif Font in the general format: MAIN   Button   MENU   ...   Button   DESTINATION MENU/DIALOG BOX For example, the navigation path to the REFERENCE PLANE menu is: MAIN   Measurement   MEASUREMENT   Reference Plane   REFERENCE PLANE
NF	Instrument mode: Noise Figure.

Abbreviation or Term	Meaning / Definition (8 of 16)
NIST	National Institute of Standards and Technology.
ns	Time units abbreviation. Nanosecond.
Ntwk Ntwk.	Network.
NxN	Application for measuring non-separable devices. NxN is used when devices can only be measured in pairs and information about the individual devices is required.
OE O/E	Optical-to-Electrical. Refers to fiber optic converters (detectors and receivers) and the measurement of such devices.
OO O/O	Optical-to-Optical. Refers to purely optical (O/O) components (couplers, amplifiers, filters, etc.) and the measurement of such devices.
Ohms/Div	SCALE menu toolbar function. Ohms ( $\Omega$ ) per trace display division.
OIPn	Output referred N <sup>th</sup> order intercept point. Used in IMD measurements.
OM	Anritsu Operations Manual
Op.	Operand, Operation, Operations.
Order	The level of nonlinearity that is being observed in a given product. Used in IMD measurements.
Out.	Output.
P2P	Pulse-to-Pulse.
Param.	Parameter, Parameters.
PDF	Proprietary Portable Document Format from Adobe Corporation.
PG	Pulse Generator.
PIP	Point-in-Pulse.
PM	Anritsu Programming Manual.
Prev Prev.	Previous.
PRF	Pulse Repetition Frequency.
PRI	Pulse Repetition Interval.
Profile	Pulse Profile.
ps	Time units abbreviation. Picosecond.
PulseView™	Anritsu Company trademarked application used for making pulse measurements.
Pwr Pwr.	Power.
R	Resistance.
R(P), R(S)	Parallel Resistance, Series Resistance.
R-Circuit	Resistive element of an L-C circuit.

Abbreviation or Term	Meaning / Definition (9 of 16)
RCKTFour	A four-node resistive R circuit. Port assignments are defined in separate commands. Available if the instrument is in 4-Port VNA mode.
Rcvr Rcvr.	Receiver.
Rect.	Reactance, Rectangle, Rectangular.
Ref.Mkr	Reference Marker.
Ref Ref.	Reference.
RESP1	Abbreviation for one-port response calibration. Used in the SCPI command :SENSe{1-16}:CORRection:COLLect[:METHod]:RESP1 to simulate the calibration.
RESPB	Abbreviation for one-port response calibration both ports. Used in the SCPI command :SENSe{1-16}:CORRection:COLLect[:METHod]:RESPB to simulate the calibration.
RF	Radio Frequency.
RP	Resistive parallel network. Available if the instrument is in 2-Port VNA mode.
RS	Resistive series network. Available if the instrument is in 2-Port VNA mode.
Rt	Right.
s	Time units abbreviation. Second.
S11	S-Parameter. Used in text for S-parameter measurement of input reflection coefficient. In text written as “S11”. Mathematical version uses subscripts as $S_{11}$ . Available in 2-Port and 4-Port VNAs.
S12	S-Parameter. Used in text for S-parameter measurement of reverse transmission coefficient. Mathematical version uses subscripts as $S_{12}$ . Available in 2-Port and 4-Port VNAs.
S13	S-Parameter. Used in test for S-parameter measurement. Mathematical version used subscripts as $S_{13}$ . Available only in 4-Port VNAs.
S14	S-Parameter. Used in test for S-parameter measurement. Mathematical version used subscripts as $S_{14}$ . Available only in 4-Port VNAs.
S21	S-Parameter. Used in text for S-parameter measurement of forward transmission coefficient. Mathematical version uses subscripts as $S_{21}$ . Available in 2-Port and 4-Port VNAs.
S22	S-Parameter. Used in text for S-parameter measurement of output reflection coefficient. Mathematical version uses subscripts as $S_{22}$ . Available in 2-Port and 4-Port VNAs.
S23	S-Parameter. Used in test for S-parameter measurement. Mathematical version used subscripts as $S_{23}$ . Available only in 4-Port VNAs.



Abbreviation or Term	Meaning / Definition (10 of 16)
S24	S-Parameter. Used in test for S-parameter measurement. Mathematical version used subscripts as $S_{23}$ . Available only in 4-Port VNAs.
s2p	File extension. Abbreviation for S-parameter 2-Port configuration file. The general type of file extension is referred to an “.snp” file where the “n” refers to the number of ports, such as “.s1p” for an S-parameter 1-Port configuration file.
S2Pfile	Allows an S2P calibration file to be used. Available if the instrument is in 2-Port VNA mode.
S31	S-Parameter. Used in test for S-parameter measurement. Mathematical version used subscripts as $S_{31}$ . Available only in 4-Port VNAs.
S32	S-Parameter. Used in test for S-parameter measurement. Mathematical version used subscripts as $S_{32}$ . Available only in 4-Port VNAs.
S33	S-Parameter. Used in test for S-parameter measurement. Mathematical version used subscripts as $S_{33}$ . Available only in 4-Port VNAs.
S34	S-Parameter. Used in test for S-parameter measurement. Mathematical version used subscripts as $S_{34}$ . Available only in 4-Port VNAs.
S41	S-Parameter. Used in test for S-parameter measurement. Mathematical version used subscripts as $S_{41}$ . Available only in 4-Port VNAs.
S42	S-Parameter. Used in test for S-parameter measurement. Mathematical version used subscripts as $S_{42}$ . Available only in 4-Port VNAs.
S43	S-Parameter. Used in test for S-parameter measurement. Mathematical version used subscripts as $S_{43}$ . Available only in 4-Port VNAs.
S44	S-Parameter. Used in test for S-parameter measurement. Mathematical version used subscripts as $S_{44}$ . Available only in 4-Port VNAs.
S4Pfile	Allows an S4P calibration file to be used. Available if the instrument is in 4-Port VNA mode.
SC1C1	Two differential pairs. Trace labeling for Mixed-mode with two differential pairs. S-parameter for common-mode reception at Pair 1 and common-mode drive at Pair 1.
SC1C2	Two differential pairs. Trace labeling for Mixed-mode with two differential pairs. S-parameter for common-mode reception at Pair 1 and common-mode drive at Pair 2.
SC1D1	Two differential pairs. Trace labeling for Mixed-mode with two differential pairs. S-parameter for common-mode reception at Pair 1 and differential drive at Pair 1.
SC1D2	Two differential pairs. Trace labeling for Mixed-mode with two differential pairs. S-parameter for common-mode reception at Pair 1 and differential drive at Pair 2.

Abbreviation or Term	Meaning / Definition (11 of 16)
SC2C1	Two differential pairs. Trace labeling for Mixed-mode with two differential pairs. S-parameter for common-mode reception at Pair 2 and common-mode drive at Pair 1.
SC2C2	Two differential pairs. Trace labeling for Mixed-mode with two differential pairs. S-parameter for common-mode reception at Pair 2 and common-mode drive at Pair 2.
SC2D1	Two differential pairs. Trace labeling for Mixed-mode with two differential pairs. S-parameter for common-mode reception at Pair 2 and differential drive at Pair 1.
SC2D2	Two differential pairs. Trace labeling for Mixed-mode with two differential pairs. S-parameter for common-mode reception at Pair 2 and differential drive at Pair 2.
SCC	<p>One differential pair and one singleton. Trace labeling for Mixed-mode with common-mode reception at Pair 1 and common-mode drive at Pair 1. S-Parameter for common-mode reception at Pair 1 and common-mode drive at Pair 1.</p> <p>One differential pair and two singletons. Trace labeling for Mixed-mode for Pair 1 common-mode reception and Pair 1 drive. S-Parameter for common-mode reception at Pair 1 and common-mode drive at Pair 1.</p> <p>Trace labeling for Mixed-mode with common-mode reception at Pair 1 and common-mode drive at Pair 2. S-Parameter for common-mode reception at Pair 1 and common-mode drive at Pair 1.</p>
SCD	<p>One differential pair and one singleton. Trace labeling for Mixed-mode for Pair 1 reception and Pair 1 drive. S-Parameter for common-mode reception at Pair 1 and differential drive at Pair 1.</p> <p>One differential pair and two singletons. Trace labeling for Mixed-mode with common-mode reception at Pair 1 and differential drive at Pair 2. S-Parameter for common-mode reception at Pair 1 and differential drive at Pair 1.</p>
SCX	<p>One differential pair and one singleton. Trace labeling for Mixed-mode with Pair 1 common-mode reception and singleton drive. S-Parameter for common-mode reception at Pair 1 and singleton drive.</p> <p>One differential pair and two singletons. Trace labeling for Mixed-mode with common-mode reception at Pair 1 and drive at first singleton. S-Parameter for common-mode reception at Pair 1 and first singleton drive.</p>
SCY	One differential pair and two singletons. Trace labeling for Mixed-mode with common-mode at Pair 1 and drive at second singleton. S-Parameter for common-mode reception at Pair 1 and second singleton drive.
SD1C1	Two differential pairs. Trace labeling for Mixed-mode with two differential pairs. S-parameter for differential reception at Pair 1 and common-mode drive at Pair 2.
SD1C2	Two differential pairs. Trace labeling for Mixed-mode with two differential pairs. S-parameter for differential reception at Pair 1 and common-mode drive at Pair 2.

Abbreviation or Term	Meaning / Definition (12 of 16)
SD1D1	Two differential pairs. Trace labeling for Mixed-mode with two differential pairs. S-parameter for differential reception at Pair 1 and differential drive at Pair 2.
SD1D2	Two differential pairs. Trace labeling for Mixed-mode with two differential pairs. S-parameter for differential reception at Pair 1 and differential drive at Pair 2.
SD2C1	Two differential pairs. Trace labeling for Mixed-mode with two differential pairs. S-parameter for differential reception at Pair 2 and common-mode drive at Pair 1.
SD2C2	Two differential pairs. Trace labeling for Mixed-mode with two differential pairs. S-parameter for differential reception at Pair 2 and common-mode drive at Pair 2.
SD2D1	Two differential pairs. Trace labeling for Mixed-mode with two differential pairs. S-parameter for differential reception at Pair 2 and differential drive at Pair 1.
SD2D2	Two differential pairs. Trace labeling for Mixed-mode with two differential pairs. S-parameter for differential reception at Pair 2 and differential drive at Pair 2.
SDC	<p>One differential pair and one singleton. Trace labeling for Mixed-mode for Pair 1 reception and Pair 1 drive. S-Parameter for differential reception at Pair 1 and common-mode drive at the port pair.</p> <p>One differential pair and two singletons. Trace labeling for Mixed-mode with differential reception at Pair 1 and common-mode drive at Pair 1. S-Parameter for differential reception and common-mode drive at Pair 1.</p>
SDD	<p>One differential pair and one singleton. Trace labeling for Mixed-mode for Pair 1 reception and Pair 1 drive. S-Parameter for differential reception and differential drive.</p> <p>One differential pair and two singletons. Trace labeling for Mixed-mode with differential reception at Pair 1 and differential drive at Pair 1. S-Parameter for differential reception and differential drive at Pair 1.</p>
SDX	<p>One differential pair and one singleton. Trace labeling for Mixed-mode for Pair 1 reception and singleton drive. S-Parameter for differential reception at Pair 1 and singleton drive.</p> <p>One differential pair and two singletons. Trace labeling for Mixed-mode with differential reception at Pair 1 and drive at first singleton. S-Parameter for differential reception at Pair 1 and first singleton drive.</p>
SDY	One differential pair and two singletons. Trace labeling for Mixed-mode with differential reception at Pair 1 and drive at second singleton. S-Parameter for differential reception at Pair 1 and second singleton drive.
Seg.	Segment, Segmented.
SerNum	Serial Number.
Set.	Settings.
SI	International System of Units.

Abbreviation or Term	Meaning / Definition (13 of 16)
Single Offset	Calibration method.
Soft buttons	Buttons that appear in the right side menu interface on the MS464xB Series VNA screen. In text, the name of the menu is formatted with a distinctive font in capitals, such as the FREQUENCY menu. Soft buttons on each menu, such as the Select Port toggle button are formatted in the same font with initial capitals.
Soft key	Not used. See “Soft buttons”. The word “key” is reserved for the front panel “Hard keys, keys”. Other Anritsu products use this term to describe display screen buttons.
SOLT/SOLR	Calibration methods. Short-open-load-thru or short-open-load-reciprocal calibration algorithm.
SPA	Instrument mode: Spectrum Analysis..
Sparam	S-Parameters or scattering parameters.
S-Parameters s-parameters	Scattering parameters.
Src Src.	Source.
SRPRP SRR SXR SRX SXX	General button format for mixed mode settings. In 4-port VNA mixed mode settings, this is the name format of the selectable button names. For buttons with five letters, “S” indicates a mixed mode S-Parameter, “R” is the selected response type of either “D” for differential or “C” for common mode, and “P” is the Port number between 1 and 4. For buttons with three letters, “S” indicates a mixed-mode S-Parameter, “R” is the selected response type of either “D” for differential or “C” for common mode, and “X” is the singleton drive.
SSD	Solid State Drive.
SSLT/SSLR	Calibration methods. Short-short-load-thru or short-short-load-reciprocal calibration algorithm
SSST/SSSR	Calibration methods. Short-short-short-thru or short-short-short-reciprocal calibration algorithm. Also called “Triple Offset Short”.
Swp	Sweep.
SWR	Standing Wave Ratio.
SXC	One differential pair and one singleton. Trace labeling for Mixed-mode with first singleton reception and common-mode drive at Pair 1. S-Parameter for first singleton reception and common-mode drive at Pair 1.  One differential pair and two singletons. Trace labeling for Mixed-mode with singleton reception and differential drive. S-Parameter for singleton reception and common-mode drive at Pair 1.
SXD	One differential pair and one singleton. Trace labeling for Mixed-mode with singleton reception and Pair 1 drive. S-Parameter for singleton reception and differential drive at Pair 1.  One differential pair and two singletons. Trace labeling for Mixed-mode with first singleton reception and differential drive at Pair 1. S-Parameter for first singleton reception and differential drive at Pair 1.

Abbreviation or Term	Meaning / Definition (14 of 16)
SXX	<p>One differential pair and one singleton. Trace labeling for Mixed-mode with singleton reception and singleton drive. S-Parameter for singleton reception and singleton drive.</p> <p>One differential pair and two singletons. Trace labeling for Mixed-mode with first singleton reception and first singleton drive. S-Parameter for first singleton reception and first singleton drive.</p>
SXY	<p>One differential pair and two singletons. Trace labeling for Mixed-mode with first singleton reception and first singleton drive. S-Parameter for first singleton reception and second singleton drive.</p>
SYC	<p>One differential pair and two singletons. Trace labeling for Mixed-mode with second singleton reception and common-mode drive at Pair 1. S-Parameter for second singleton reception and common-mode drive at Pair 1.</p>
SYD	<p>One differential pair and two singletons. Trace labeling for Mixed-mode with second singleton reception and differential drive at Pair 1. S-Parameter for second singleton reception and differential drive at Pair 1.</p>
SYX	<p>One differential pair and two singletons. Trace labeling for Mixed-mode with second singleton reception and first singleton drive. S-Parameter for second singleton reception and first singleton drive.</p>
SYY	<p>One differential pair and two singletons. Trace labeling for Mixed-mode with second singleton reception and second singleton drive. S-Parameter for second singleton reception and second singleton drive.</p>
TCP	<p>Transmission Control Protocol. Part of the Ethernet network communication protocol.</p>
TDS	<p>Anritsu Technical Data Sheet. Document location of the most recent instrument performance specifications.</p>
TFRB	<p>Abbreviation for transmission frequency response calibration both directions. Used in the SCPI command :SENSe{1-16}:CORRection:COLLect[:METHod]:TFRB to simulate the calibration.</p>
TFRF	<p>Abbreviation for transmission frequency response calibration forward direction. Used in the SCPI command :SENSe{1-16}:CORRection:COLLect[:METHod]:TFRF to simulate the calibration.</p>
TFRR	<p>Abbreviation for transmission frequency response calibration reverse direction. Used in the SCPI command :SENSe{1-16}:CORRection:COLLect[:METHod]:TFRR to simulate the calibration.</p>
TLine	<p>A defined transmission line with specifications for Impedance (Ohms), Length (meters), Loss (dB/mm), @ Frequency (GHz), and Dielectric Value. Note that programmatically, length is entered in meters. From the user interface, length is usually entered in millimeters. Available if the instrument is in 2-Port VNA mode.</p>
T-Line	<p>Transmission line.</p>

Abbreviation or Term	Meaning / Definition (15 of 16)
TLINEFour	Allows two separate through (“thru”) lines to be used. In separate commands, each link is defined by Length (meters), @ Frequency (GHz), Z0-Odd (Ohms), Loss-Odd (dB/mm), Dielectric Odd (unitless number), Z0-Even (Ohms), Loss-Even (dB/mm), and Dielectric Even (unitless number). Note that programmatically, length is entered in meters. From the user interface, length is usually entered in millimeters. Available if the instrument is in 4-Port VNA mode.
TMS	True Mode Stimulus.
Toggle Button	A software (“Soft Key”) button that toggles between two or more states such as ON and OFF or Port 1 and Port 2.
TR	Instrument mode. Transmission/reflection mode.
Transf Transf.	Transfer, Transformation.
Triple Offset Short	Calibration method. Short-short-short-thru. Commonly abbreviated as “SSST.”
TRL	Thru Reflect Line Calibration method. See <a href="#">LRL/LRM</a> .
TRM	Thru Reflect Match Calibration method. See <a href="#">ALRM A-LRM™</a> .
Tr Tr.	Trace.
TS	Troubleshooting.
TS Mode	Troubleshooting Mode.
TTL	Transistor-Transistor Logic.
U	Units.
um	Distance units abbreviation. Micrometer.
Units/Div	SCALE menu toolbar function. Measurement units per trace display division.
us	Time units abbreviation. Microsecond.
USB	Universal Serial Bus.
USB key	See <a href="#">USB Memory Device</a> .
USB Memory Device	<p>Also called a “USB flash drive”, “USB stick”, “thumb drive”, or “memory stick.” In the context of Anritsu documentation, a USB memory device is used to transfer calibration, certification, and/or operating system updates to the MS464xB instrument.</p> <p>When the instrument interface or hardware uses another term such as “Calibration Memory Device,” its first use is always followed by the “USB Memory Device” in parenthesis.</p> <p>For example: “...use the Calibration Memory Device (USB Memory Device) to load the characterization parameters for the calibration kit...”</p>
USB stick	See <a href="#">USB Memory Device</a> .
UTF	Universal Test Fixture.
V	Volts. Voltage.
V AC	Volts Alternating Current.

Abbreviation or Term	Meaning / Definition (16 of 16)
V Connector™	Anritsu Company trademarked connector name. Connector type. A 1.85 mm coaxial connector with a rated frequency range from DC to 65 GHz. V Connector is a trademark of Anritsu Company.
V DC	Volts Direct Current.
VCO	Voltage Control Oscillator.
VISA	Virtual Instrument System Architecture.
VNA	Vector Network Analyzer.
VSWR	Voltage Standing Wave Ratio.

# Index

## Symbols

- . (Decimal) Key ..... 3-9
- +/- (Plus/Minus) Key ..... 3-9

## Numerics

- 10 MHz In ..... 3-18
- 10 MHz Out ..... 3-18
- 100,000 Points ..... 1-2, 4-43
- 25,000 Points ..... 1-2, 4-43

## A

- a1 Access Loop ..... 3-24
- a2 Access Loop ..... 3-24
- ABOUT VECTORSTAR Dialog Box ..... 4-20
- AC Power Entry Module ..... 2-3
- AC Power Rocker Switch ..... 2-3
- ACCESS LOOPS ..... 3-24
- Additional Drive ..... C-3
- airflow ..... 2-2
- altitude, operating ..... 2-2
- Analog In 2 ..... 3-21
- Anritsu
  - Contacting ..... 1-1
  - Product Information ..... 1-1
- Anritsu Part Numbers
  - MS4642B VNA ..... 1-3
  - MS4644B VNA ..... 1-3
  - MS4645B VNA ..... 1-3
  - MS4647B VNA ..... 1-3
- Antivirus Protection ..... 1-9
- APPLICATION Drop-Down Menu ..... 4-15
- Application Icon ..... 4-22
- Application Key ..... 4-7
- AutoCal modules ..... 1-4
- Auto-Return Button Group ..... 4-36
- Average Icon ..... 4-22
- Average Key ..... 3-6, 4-7

## B

- b1 Access Loop ..... 3-24
- b2 Access Loop ..... 3-24
- Back Button ..... 4-32
- Backspace / Delete Key ..... 3-9
- Bias Fuse Port 1 ..... 3-23
- Bias Fuse Port 2 ..... 3-23
- Bias Fuse Replacement ..... C-8
- Bias Input Port 1 Connector ..... 3-22
- Bias Input Port 2 Connector ..... 3-22
- Button Selection Groups ..... 4-35
- Button Selection Icon ..... 4-34

## C

- CALIBRATION Drop-Down Menu ..... 4-15
- Calibration Icon ..... 4-22

- Calibration Key ..... 3-5, 4-7
- Calibration Kits ..... 1-4
- Calibration Verification Interval ..... 2-19
- Ch->Max Icon ..... 4-22
- Ch->Next Icon ..... 4-22
- Ch->Prev Icon ..... 4-22
- Channel Display ..... 4-5
- CHANNEL Drop-Down Menu ..... 4-12
- Channel Icon ..... 4-23
- Channel Key ..... 3-7, 4-7
- Channel Status Bar Abbreviations ..... 4-42
- Channel Status Display ..... 4-42
- Chassis Grounding Port ..... 3-4
- Clear/Tab Key ..... 3-9
- Completion Checkmark Button ..... 4-37
- Complex Impedance ..... 4-47
- Configuring TCP/IP Ethernet ..... 2-18
- Connecting External Devices ..... 2-2
- Connectors ..... 3-2
- Contacting Anritsu ..... 1-1
- Continue Icon ..... 4-23
- cooling, during operation ..... 2-2
- Custom Icon ..... 4-23

## D

- Dedicated GPIB Port ..... 2-9, 3-20
- default GPIB addresses ..... 2-12
- Dialog Boxes ..... 4-37
- Digit Keys ..... 3-9
- Dimensions ..... C-9
- Display Areas ..... 4-2
- Display Icon ..... 4-24
- Display Key ..... 3-7, 4-7
- Document Part Numbers ..... 1-5
- Down Arrow Key ..... 3-8
- DRAM and Flash Memory ..... C-1

## E

- Enter Key ..... 3-9
- Environment ..... 2-2
- environment
  - storage ..... C-9
- Ethernet ..... 1-3, 2-16
- Ext ALC ..... 3-16
- Ext Analog Out ..... 3-16
- Ext Trigger ..... 3-21
- External Devices ..... 2-6
- External Fuses ..... C-7
- External I/O Port ..... 3-19
- External Source 1 = 4 ..... 2-12
- External Source 2 = 5 ..... 2-12
- External Source 3 = 2 ..... 2-12
- External Source 4 = 3 ..... 2-12
- External XGA/VGA Monitor ..... 2-7



<b>F</b>	
FILE Drop-Down Menu	4-10
File Icon	4-24
File Key	3-5, 4-7
Freq Icon	4-24
Frequency Blanking	4-66
Frequency Counter = 7	2-12
Frequency Key	3-6, 4-7
Front Panel	3-1
front panel buttons	1-3
Fuse Maintenance	C-7

<b>G</b>	
GPIO	1-3
GPIO Address	2-15
GPIO Address, Configuring	2-15
GPIO interface cable	2-9
GPIO Port	3-20
GPIO Setup	2-9
green Operate LED	2-3
Group Delay	4-47, 4-50
Group Delay Graphs	4-60

<b>H</b>	
Hard Keys	3-2
HELP Drop-Down Menu	4-19
Help Icon	4-24
Help Key	3-5, 4-7
Hold Icon	4-24
Home Button	4-32
HP/Agilent 8510x	2-19
humidity, operating	2-2

<b>I</b>	
Icon Toolbar	4-21
Icon Toolbar Functions	4-21
IEC C14 AC Power Socket (m)	2-3
IEEE 488.2 General Purpose Interface Bus (GPIO)	1-3
IEEE 488.2 GPIO Port	2-14, 3-20
Imaginary	4-48
Impedance	4-48
Initial Inspection	2-1
Input/Outputs a1 IF	3-17
Input/Outputs a2 IF	3-17
Input/Outputs b1 IF	3-17
Inspection	2-1
Installation	2-1
installation category	2-2
Instrument Status	4-40
Instrument Status Display Abbreviations	4-41
Internal Drive	C-1
Internal Fuses	C-7

<b>K</b>	
Keyboard	2-6
Keyboard PS/2 Port	3-22

<b>Keys</b>	
Calibration	3-5
Standby/Operate	3-4

<b>L</b>	
LAN Ethernet Port	3-22
LAN TCP/IP	2-16
LED	2-3
Left Arrow Key	3-8
Lightning	2-19
Limit Lines	4-65
Linear Mag	4-48
Linear Magnitude and Phase	4-49
Lock Status	3-21
Log Mag	4-47
Log Magnitude and Phase	4-49
Log Polar	4-48

<b>M</b>	
Main Screen	4-1
Maintaining Operating System Integrity	1-9
Maintenance	C-7
Manual Updates	1-1
Marker Icon	4-25
Marker Key	3-7, 4-7
Marker-> Pk Rt Icon	4-25
Marker->Max Icon	4-24
Marker->Min Icon	4-24
Marker->Off	4-25
Marker->Peak Icon	4-25
Marker->Pk Lft Icon	4-25
MEASUREMENT Drop-Down Menu	4-15
Measurement Icon	4-25
Measurement Key	4-7
Menu Bar	4-8
Menu Bar Drop-Down Menus	4-9
Menu Navigation Buttons	4-32
MN4694B Test Set	2-12
MN4797B Test Set	2-12
Models	1-3
Monitor	2-7
Mouse	2-6
mouse	1-3
Mouse PS/2 Port	3-22
Multiple Channel User Interface	4-4
Multiport Test Set = 16	2-12

<b>N</b>	
Native	2-19
Navigation	1-8
Next Button	4-32
Number of Points	4-43

<b>O</b>	
Operate Mode	2-4
Operating Environment	2-9
Operating System Integrity	1-9

Optional Icon Toolbar Functions .....	4-21
Options .....	1-3
orange Standby LED .....	2-3
Other VectorStar Documentation .....	1-5

**P**

Peripherals .....	2-8
Phase .....	4-48
Phase and Magnitude .....	4-47
phase, of power supply .....	2-2
Plug-and-Play .....	2-16
Polar Graphs .....	4-60
Port	
Grounding .....	3-4
Port 1 Src Loop .....	3-24
Port 2 Src Loop .....	3-24
Power Graphs .....	4-62
Power Icon .....	4-25
Power In .....	4-50
Power Key .....	3-6, 4-7
Power Meter = 13 .....	2-12
Power Meter = 15 .....	2-12
Power Meter = 17 .....	2-12
Power Meter = 18 .....	2-12
Power Out .....	4-50
Power Requirements .....	2-2
Power Socket .....	2-3
Power-On/Power-Off Procedure .....	2-3
Preparation for Use .....	2-1
Preset Icon .....	4-26
Preset Key .....	3-6, 4-7
Previous .....	1-8
Print Icon .....	4-26
Printer .....	2-8
Product Information .....	1-1
PS/2 Port .....	3-22

**R**

Rack Mount Installation .....	C-4
Ready for Trigger .....	3-21
Real .....	4-48
Real and Imaginary .....	4-47, 4-49
Rear Panel .....	2-7, 3-1
Rear Panel Ports and Connectors .....	3-12
Receive - Port 1 .....	3-10
Receive - Port 2 .....	3-11
Recovery .....	C-2
Rectilinear Paired Graphs .....	4-57
Rectilinear Single Graph .....	4-54
Reference Lines .....	4-64
Reference Position .....	4-64
Related VectorStar Documentation .....	1-5
Remote Language .....	2-19
Response Icon .....	4-26
Response Key .....	3-7, 4-7
RJ-45 Ethernet Port .....	2-17
Rotary Knob .....	3-8

**S**

Scale Icon .....	4-26
Scale Key .....	3-7, 4-7
Security Concerns for Memory .....	1-8
Select Key .....	3-8
Serial Port .....	3-16
Shipment .....	C-9
shipping instrument .....	C-9
Smith (G + jB) .....	4-49
Smith (R + jX) .....	4-49
Smith Charts .....	4-58
Solid State Drive (SSD) .....	C-1
Source - Port 1 .....	3-10, 3-11
Splash Screen .....	2-5
SSD .....	C-1
Standby Mode .....	2-4
standby mode .....	2-5
Standby/Operate Key .....	3-4
Standby/Operate key .....	2-3
Startup Splash Screen .....	2-5
Storage .....	C-9
storage environment .....	C-9
Sweep Icon .....	4-26
Sweep Key .....	3-6, 4-7
SWR .....	4-48
System Icon .....	4-26
System Identification .....	1-4
System Key .....	3-5, 4-7

**T**

temperature, operating .....	2-2
Test - Port 1 .....	3-10
Test - Port 2 .....	3-11
Test Port 1 .....	3-10
Test Port 2 .....	3-11
time, warm-up .....	2-4
Toolbar .....	4-34
Touch Screen .....	3-1
touch screen .....	1-3
Tr->Max Icon .....	4-27
Tr->Next Icon .....	4-27
TRACE Drop-Down Menu .....	4-13
Trace Icon .....	4-27
Trace Key .....	3-7, 4-7
Trace Label Abbreviations .....	4-51, 4-52
Traces .....	4-6
Trigger Out .....	3-21

**U**

Unpacking the Product .....	2-1
Up Arrow Key .....	3-8
Updated Manuals .....	1-1
Updates .....	1-9
USB 2.0 Type A Ports .....	2-7
USB 2.0 Type A ports .....	2-17
USB keyboard .....	1-3
USB LAN .....	1-3

## V to X

---

USB Peripherals .....	2-8
USB Ports .....	3-11
USB Setup .....	2-16
USB Type 2 Port .....	2-17
User Input .....	1-8
User Interface Navigation .....	1-8

### V

ventilation .....	2-2
Verification Kits .....	1-5
Video Port .....	3-15
VNA models .....	1-3

voltage, of power supply .....	2-2
--------------------------------	-----

### W

Warm-up Time .....	2-4
warm-up time .....	2-4

#### Web Links

Contact .....	1-1
Product Page .....	1-1, 1-5
Windows Updates .....	1-9


### X

XGA/VGA Video Port .....	3-15
--------------------------	------



# Anritsu



 Anritsu utilizes recycled paper and environmentally conscious inks and toner.

Anritsu Company  
490 Jarvis Drive  
Morgan Hill, CA 95037-2809  
USA  
<http://www.anritsu.com>