

Agilent G1701DA GC/MSD ChemStation

Getting Started



Agilent Technologies

Notices

© Agilent Technologies, Inc. 2005

No part of this manual may be reproduced in any form or by any means (including electronic storage and retrieval or translation into a foreign language) without prior agreement and written consent from Agilent Technologies, Inc. as governed by United States and international copyright laws.

Manual Part Number

G1701-90056

Edition

First edition, June 2005

Printed in USA

Agilent Technologies, Inc.

5301 Stevens Creek Boulevard

Santa Clara, CA 95052

Warranty

The material contained in this document is provided “as is,” and is subject to being changed, without notice, in future editions. Further, to the maximum extent permitted by applicable law, Agilent disclaims all warranties, either express or implied, with regard to this manual and any information contained herein, including but not limited to the implied warranties of merchantability and fitness for a particular purpose. Agilent shall not be liable for errors or for incidental or consequential damages in connection with the furnishing, use, or performance of this document or of any information contained herein. Should Agilent and the user have a separate written agreement with warranty terms covering the material in this document that conflict with these terms, the warranty terms in the separate agreement shall control.

Safety Notices

CAUTION

A **CAUTION** notice denotes a hazard. It calls attention to an operating procedure, practice, or the like that, if not correctly performed or adhered to, could result in damage to the product or loss of important data. Do not proceed beyond a **CAUTION** notice until the indicated conditions are fully understood and met.

WARNING

A **WARNING** notice denotes a hazard. It calls attention to an operating procedure, practice, or the like that, if not correctly performed or adhered to, could result in personal injury or death. Do not proceed beyond a **WARNING** notice until the indicated conditions are fully understood and met.

Contents

1 GC/MSD ChemStation Quick Reference

What is in this Book	6
Where to Find Help	7
What's New in This Revision	14
Hardware	15
ChemStation Views and Menus	20
Common ChemStation Tasks	39
Error Messages and Troubleshooting	58

2 Understanding Quantitation

Quantitation	66
Quantitation Database	69
Tutorial – Using AutoQuant Setup	77

3 Using Custom Reports

Custom Reports	92
Creating a Report Template	93
Customizing Reports	97
Selecting Cells, Rows, and Columns	102
Printing Reports	104
Creating a Custom Reports Database	107
Selecting Multiple Data Files	110

Viewing and Printing Charts 112

Custom Reports Menus 113

Custom Reports Toolbar Buttons 114

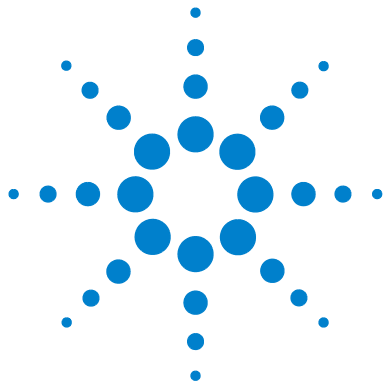

1 GC/MSD ChemStation Quick Reference

What is in this Book	6
Where to Find Help	7
What's New in This Revision	14
Hardware	15
ChemStation Views and Menus	20
Common ChemStation Tasks	39
Error Messages and Troubleshooting	58



What is in this Book

This document contains an overview of the items included with your system. It is intended to help you get started using your GC/MSD System.

In the following pages you will find:

- Details on where to find additional help
- Photos of your hardware with major parts identified
- Each menu and toolbar found in the GC/MSD ChemStation software
- Procedures for common ChemStation operations
- A summarized maintenance schedule
- A brief section on operating tips, error messages, and troubleshooting
- A review of how quantitation works with the GC/MSD ChemStation, along with a tutorial to help you get started using the time-saving AutoQuant feature
- A quick guide on how to use Custom Reports software

Please refer to your online help and the electronic manuals and videos included on your supplied CD-ROM for detailed information.

Where to Find Help



Your system comes with an extensive library of reference material including printed manuals, online help files, and electronic manuals on CD-ROM.

Each piece of hardware is accompanied by a CD-ROM (one for the GC, one for the MSD). Each CD contains hundreds of pages of in-depth reference material and maintenance videos demonstrating how to operate, maintain, and troubleshoot your equipment.

This hardware reference material includes detailed information on:

- Operating the hardware
- Maintaining the hardware
- Troubleshooting the hardware



The online help files contain extensive software operating instructions as well as tutorials on using the GC/MSD ChemStation (Enhanced, Aromatics in Gasoline, Drug Analysis, Environmental) software. Included is task and reference information on:

Instrument Control

- Using Instrument Control
- Using Methods
- Using Sequences
- Analyzing Data
- Using Batch Mode
- Tuning (Calibrating) the MSD
- Troubleshooting the MSD
- Secure Control
- Report Manager
- Commands and Functions
- Using and Writing Macros
- Glossary of Terms

Data Analysis

- Analyzing Data
- Commands and Functions
- Using and Writing Macros
- Glossary of Terms

MSD System Configuration

- Configuring Instruments
- To Configure a GPIB Card
- Troubleshooting the Network
- Typical PCS Information in MSDCHEM.INI



Printed documents are intended to help you get up and running. They include the:

- GC/MSD ChemStation Getting Started (this document)
- Site Preparation
- Software Installation Guide
- Hardware Installation Manual
- Drug Analysis Getting Started

Using online help files

The online help files contain extensive information and tutorials about instrument control, data acquisition, data analysis, methods, sequencing, tuning, troubleshooting, and how to use system commands and variables.

To access the online help, select **Help** topics from the Help menu in any window, or click the help button on any dialog box.

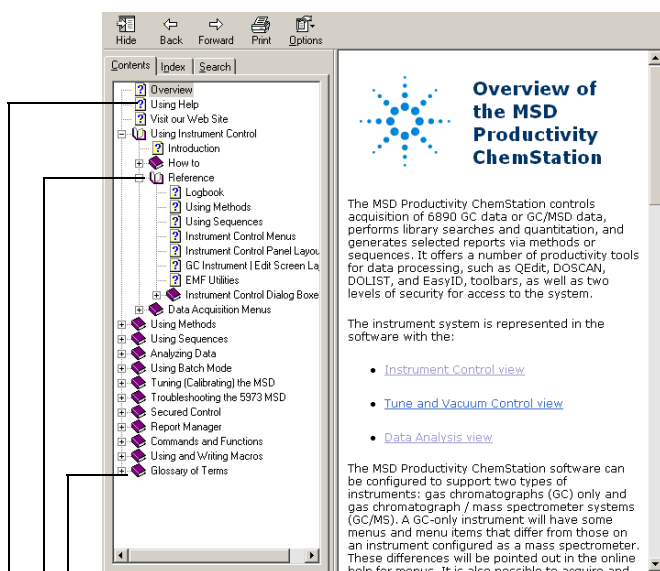

Help icons



Indicates a book containing more help topics. To open a book, select it then double-click.



Indicates an open book of help topics. To close an open book, select it then double-click.



Indicates a help topic. To jump to a help topic, select it then double-click.

Item	Description
Hide/Show	Lets you turn on or off the display of the list of help topics.
Back	Goes back to the previous help topic.
Print	Lets you print the current book or help topic.
Contents	Displays the list of help topics (shown above).
Index	Lets you use keywords to search the help index for a particular topic.
Search	Lets you type a word or phrase and then displays a list of all the topics in the online help that contain those words.
Options	Lets you change various help options such as the display of tabs.

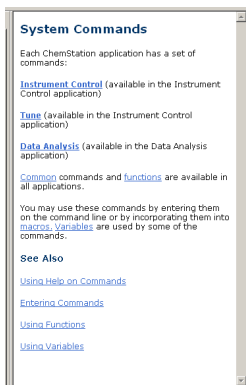

To print a single help topic:

- 1 Highlight the topic you want to print (for example, **Overview**).
- 2 Right-mouse click, and select **Print...**
- 3 Select **Print the selected topic** and click **OK**.
- 4 Verify the printer selected and click **Print**.
- 5 The information on that single topic will print. The topics linked to it will not print.

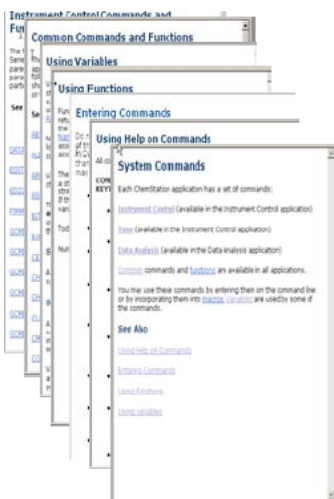
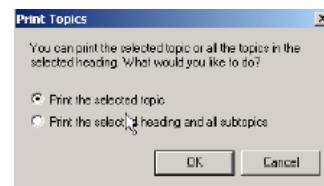
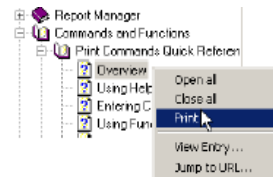

To print all subtopics in a heading at once:

- 1 Highlight the topic you want to print (for example, **Print Commands Quick Reference**).
- 2 Right-mouse click, and select **Print...**
- 3 Select **Print the selected heading and all subtopics**, and click **OK**.
- 4 Verify the printer selected, and click **Print**.
- 5 The information for ALL topics within the heading of the selected topic will print. In this case, all topics under **Print Commands Quick Reference** would print, which is about 26 pages of information.

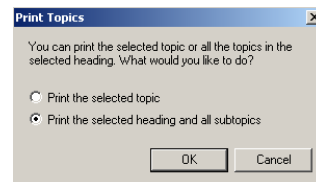
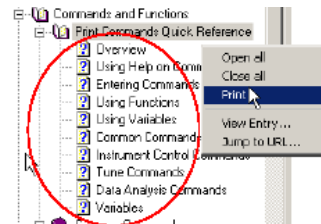

NOTE

Even if your cursor was on a single topic under this heading (say **Tune Commands**) when you select **Print all topics**, you will still receive a copy of all the topics under the heading, not just the topics below the one you happened to be on in the list.

Hardware manuals on CD-ROM

Each piece of hardware is accompanied by a CD-ROM which contains hundreds of pages of reference material as well as videos describing how to operate, maintain, and troubleshoot the equipment.

Using the manual on CD-ROM

- 1 The manuals on the CD are presented in Adobe Acrobat PDF format. The videos are incorporated into the PDF manuals (may require QuickTime), and are also viewable directly from the CD-ROM using Microsoft Media Player.
 - Access Adobe.com for a free download if you do not have Adobe Acrobat Reader.
 - Access Apple.com/quicktime for a free download of QuickTime.
- 2 Insert the CD into your disk drive and it will automatically display an opening menu, listing all the books on that CD, similar to this:



Agilent Technologies

Agilent 5975 Series MSD User Information

Introduction

This CD contains the hardware manuals and videos for the Agilent 5975 Series Mass Selective Detector (MSD).

All of the user documentation is provided as Adobe® Acrobat® Portable Document Format (PDF) files. You can read these files with Adobe® Reader® software. Visit www.adobe.com to obtain a free copy of Adobe® Reader® if you do not already have it on your system.

Click on a link below to open a manual or video.

Manuals 

[5975 Series MSD Hardware Manual](#) (Includes videos. Look for the  icon.)

[5975 Series MSD Hardware Installation](#)

[5975 Series MSD Site Preparation Guide](#)

[MSD Local Control Panel \(LCP\) Quick Reference](#)

[MS Fundamentals](#)

Sample opening menu on a Learning Products CD



- 3 Move the cursor over any of the books listed. When the cursor turns into a selection **hand**, click the left mouse button to select the book. The first page of the book and the bookmarks will be displayed.

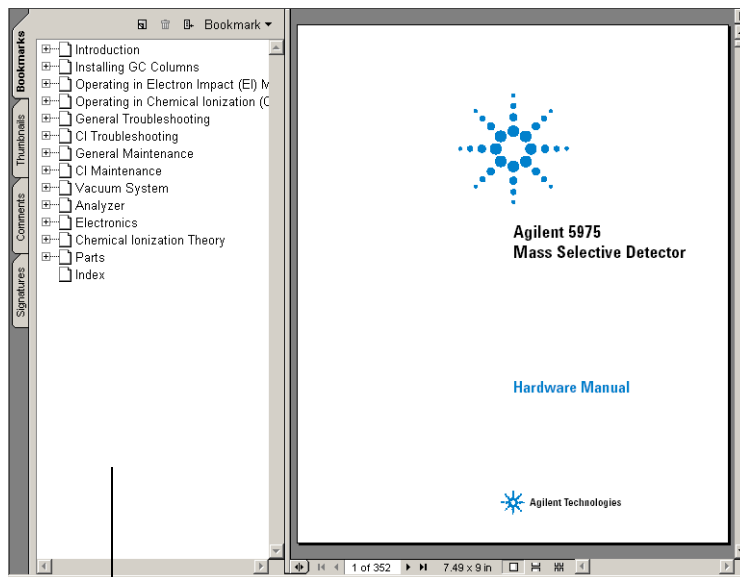

Bookmarks

Page numbers

- 4 Click any **bookmark** in the left column (such as **Operating the MSD**) and the corresponding page will be displayed.

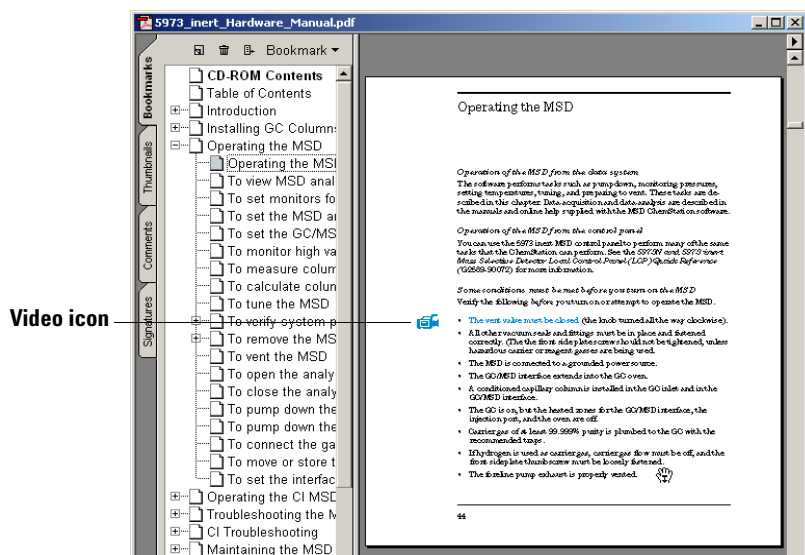

- 5 The **video** icon identifies sections that contain videos. Click this icon to see how to perform the maintenance procedure. Left mouse click to start the video clip. The video will stop automatically when finished, or you can press [Escape] to stop it whenever you want.

1 Vent the MSD. See page 64.

- 6 When you move your cursor over a cross reference, it changes to a pointing finger, which indicates the text is linked electronically to the page indicated. Click the cross reference to jump to the indicated page. Right click *to return* to the previous page.



- 7 You may print any single page, or group of pages. Select **Print**, then enter the page(s) you want printed, using the page numbers shown at the bottom of the screen.

What's New in This Revision

There are two ways to view a description of all the updates made to this version of the software:

- Following your initial configuration, select “Yes” when prompted “Do you want to view the Readme file now”.
- In either the Data Analysis, or Instrument Control view, select **Help/View Revisions Readme File**.

A text file is displayed in a pop-up window. You may scroll through this text and read it online, search it electronically, or copy it, as desired.

Select **File/Exit** to return to the application when you are ready.

Hardware

5973 MSD with a 6890 GC

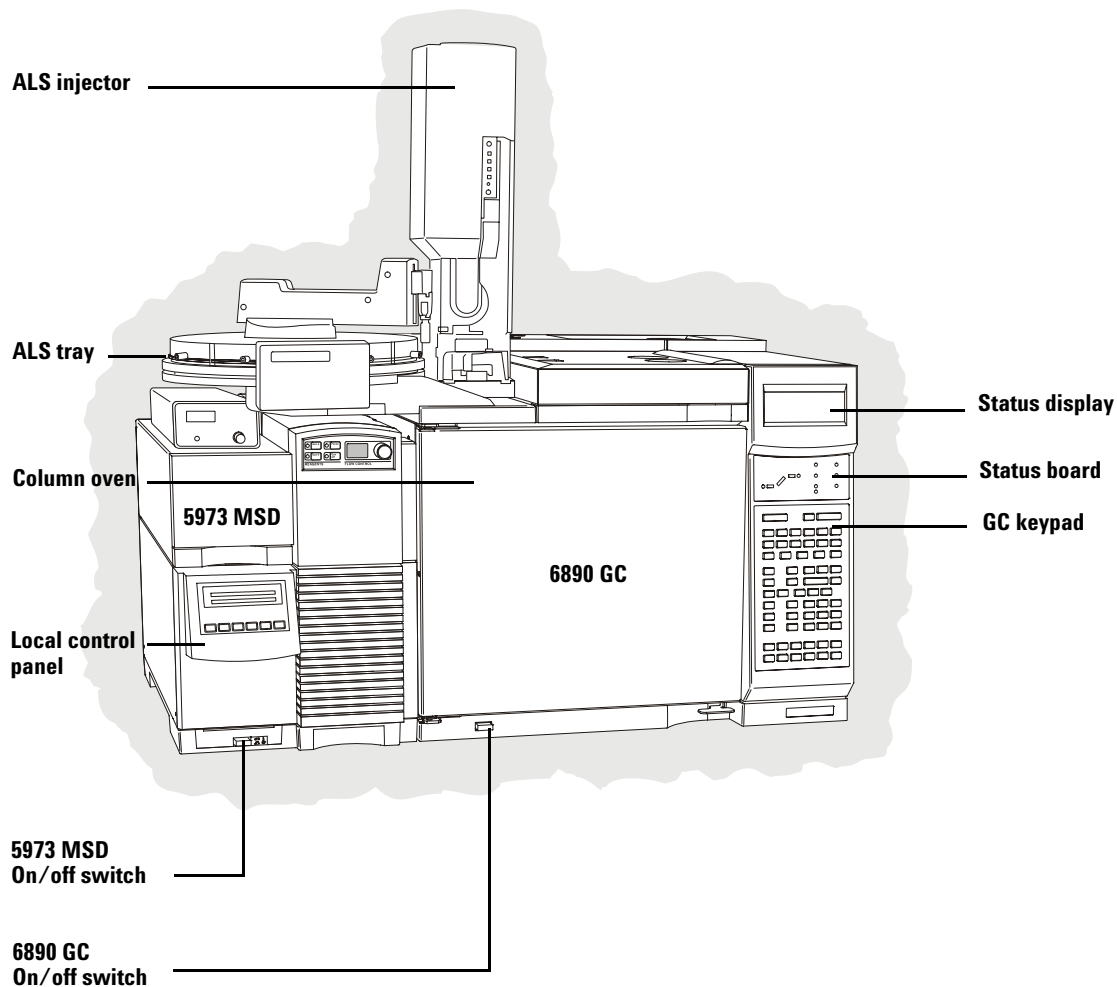

5973 MSD with a 6850 GC (G2570 MSD system)

G2613A
ALS injector (optional)

5973N MSD
(G2577A diffusion
pump model)

6850 GC
(G2630A MSD-ready
6850)

G2629A
Handheld controller (optional)



5973N

6850

G2613A

G2629A

16

5975 MSD with a 6890 GC

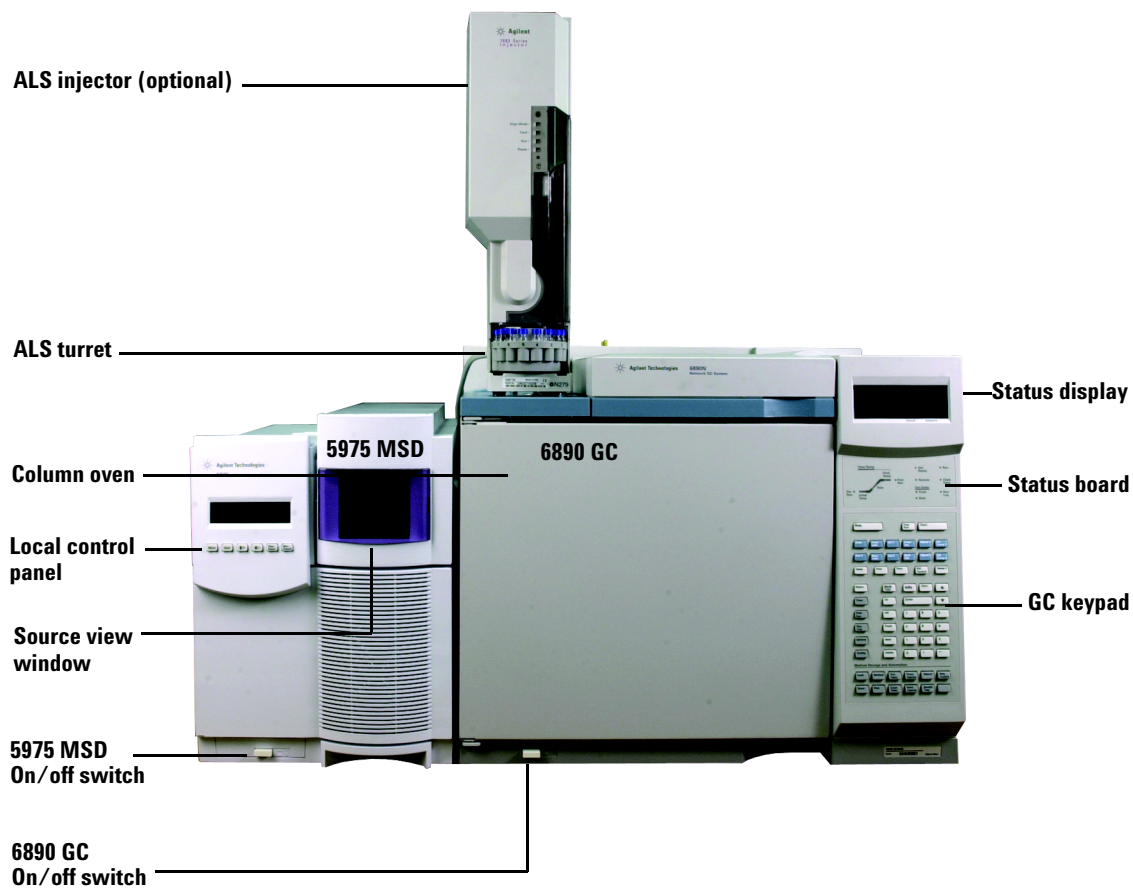

Keypad and Display for the 6850 GC

The GC/MSD ChemStation software provides instrument control for the 6850 GC. This allows you to use the software, instead of the GC keypad, to program the instrument. However, there are times when you may want to use the keypad to quickly perform one of the following tasks.

Depending on the configuration set by the control module or GC/MSD ChemStation, during a run the scrolling display can show:

- Oven temperature
- Inlet pressure
- Column flow rate
- Raw detector signal
- Messages
- Sequence information
- Run time

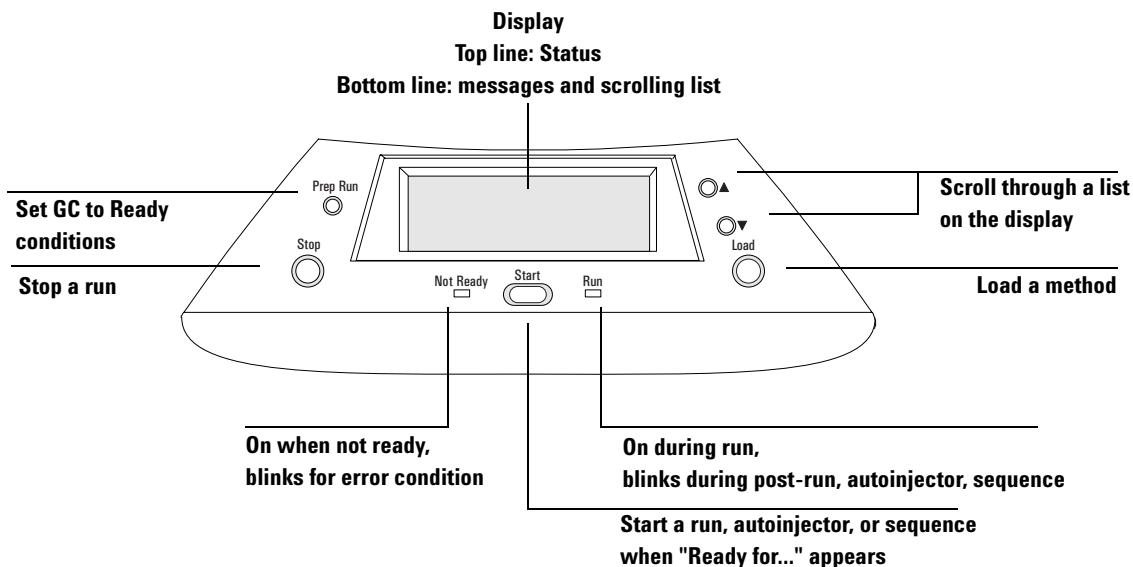

Keypad for the 6890 GC

The GC/MSD ChemStation software provides instrument control for the 6890 GC. This allows you to use the software, instead of the GC keypad, to program the instrument. However, there are times when you may want to use the keypad to quickly perform one of the following tasks.

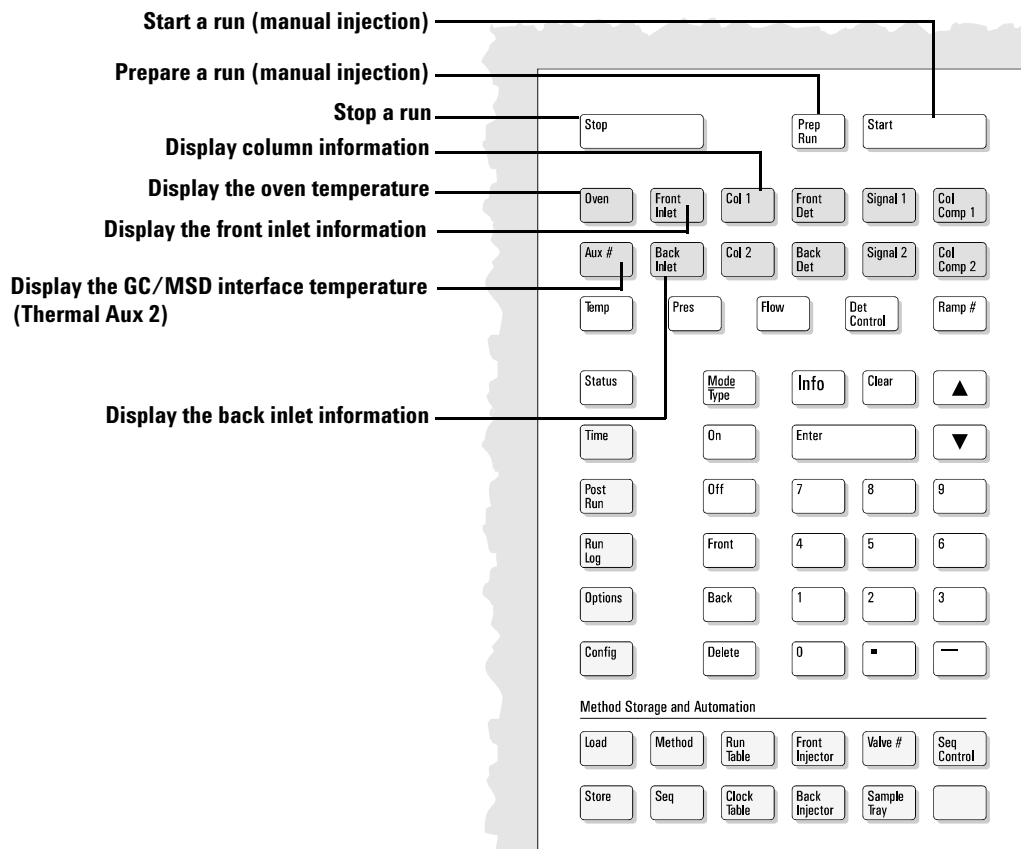

ChemStation Views and Menus

Instrument Control View

The Instrument Control view is displayed when you start up the GC/MSD ChemStation. This is where you set and monitor instrument parameters. If you are in a different view, select **View/Instrument Control** when you are ready to set up the system for data acquisition.

NOTE

See the online help for more details on the menus, buttons, or windows used in the software.

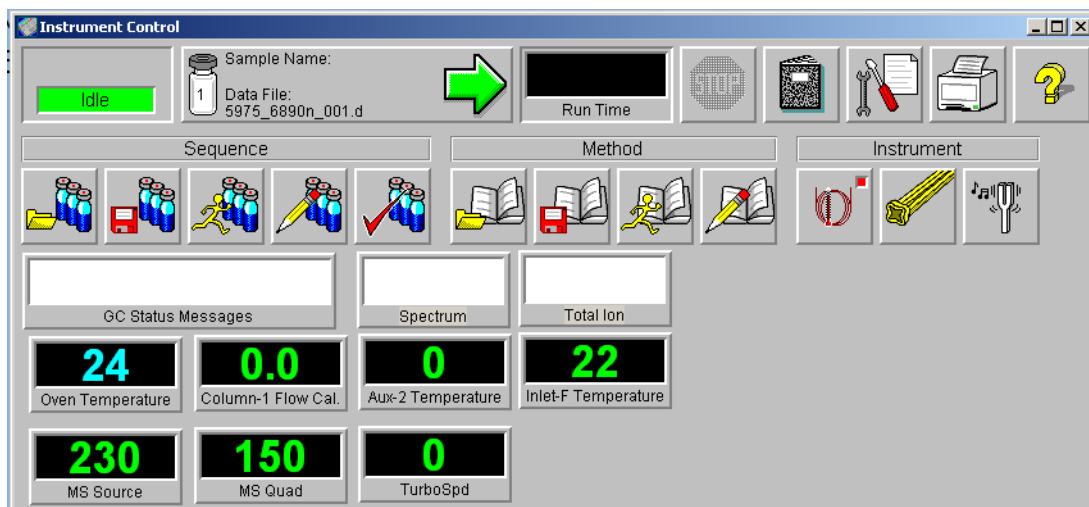

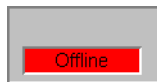

Acquisition Status Indicator

Displays the status of the current run.



Run Time

Displays the remaining time in a run.

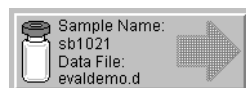

Start Run

Displays the sample name and data file ready to run.



Stop

The stop sign is red when a run is in progress and gray when a run is not in progress. Use this button to stop the system when it is in PreRun, Run, or PostRun. If the system is in Run, the system will go to PostRun. If the system is in PostRun, it will go to Idle.



Logbook

Displays the logbook popup menu.



Maintenance Due

Displays the Select early maintenance feedback (EMF) action dialog box.



Print

Displays a dialog box with such printable items as sequence log, current sequence, instrument parameters, Data Analysis parameters, and detailed Data Analysis parameters.



Help

Displays help for the Instrument Control view and gives access to the rest of the help system.



Load Sequence

Opens the Load Sequence dialog box.



Save Sequence

Opens the Save Sequence dialog box.



Run Sequence

Opens the Start Sequence dialog box.



Edit Sequence

Opens the Sample Log Table dialog box.



Simulate Sequence

Tests a sequence.



Load Method

Opens the Load Method dialog box.



Save Method

Saves the current method.



Run Method

Opens the Start Run dialog box.



Edit Method

Lets you edit the current method.



GC Parameters

Lets you edit the GC parameters and GC monitors.



MS Parameters

Lets you edit the MS parameters and MS monitors.



Tune Parameters

Lets you tune the MSD.

Instrument Control Menus

Select **View/Instrument Control** to access these menus.

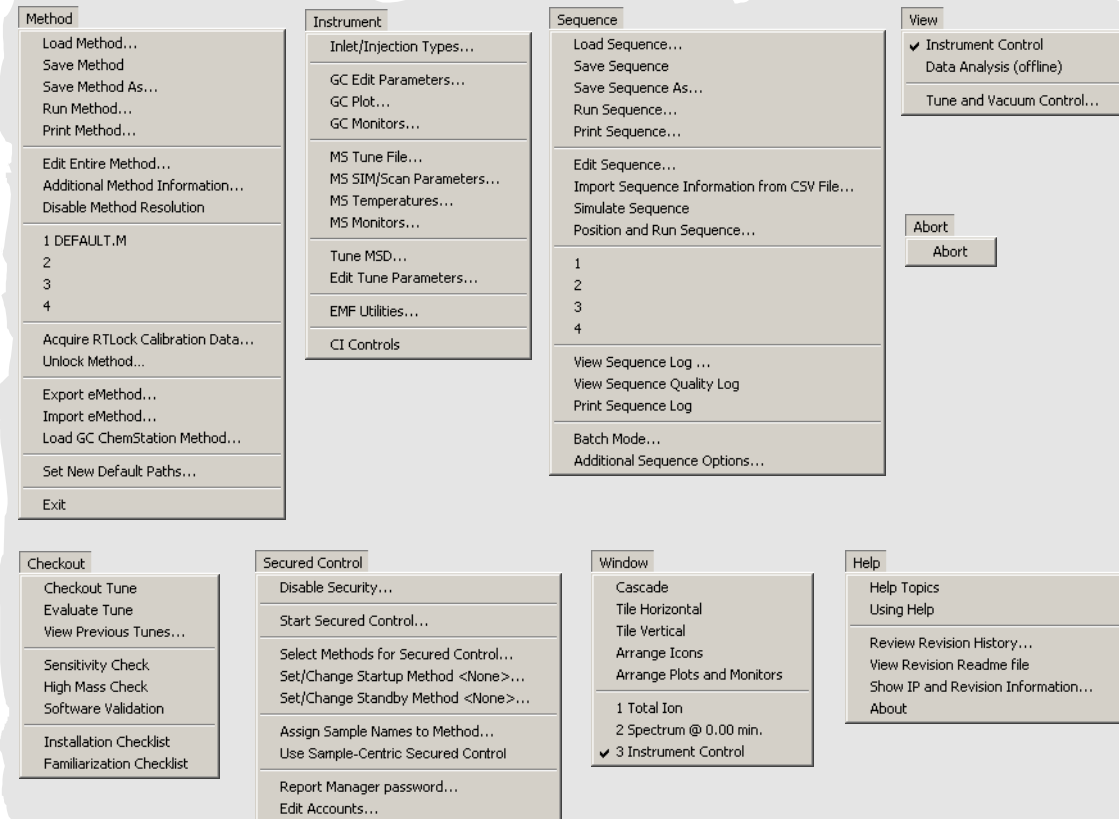

NOTE

The software menus shown in this book are for an GC/MSD ChemStation in Enhanced Mode.

Tune and Vacuum Control Menus - EI Mode

Select **View/Tune and Vacuum Control** from Instrument Control to access these menus.

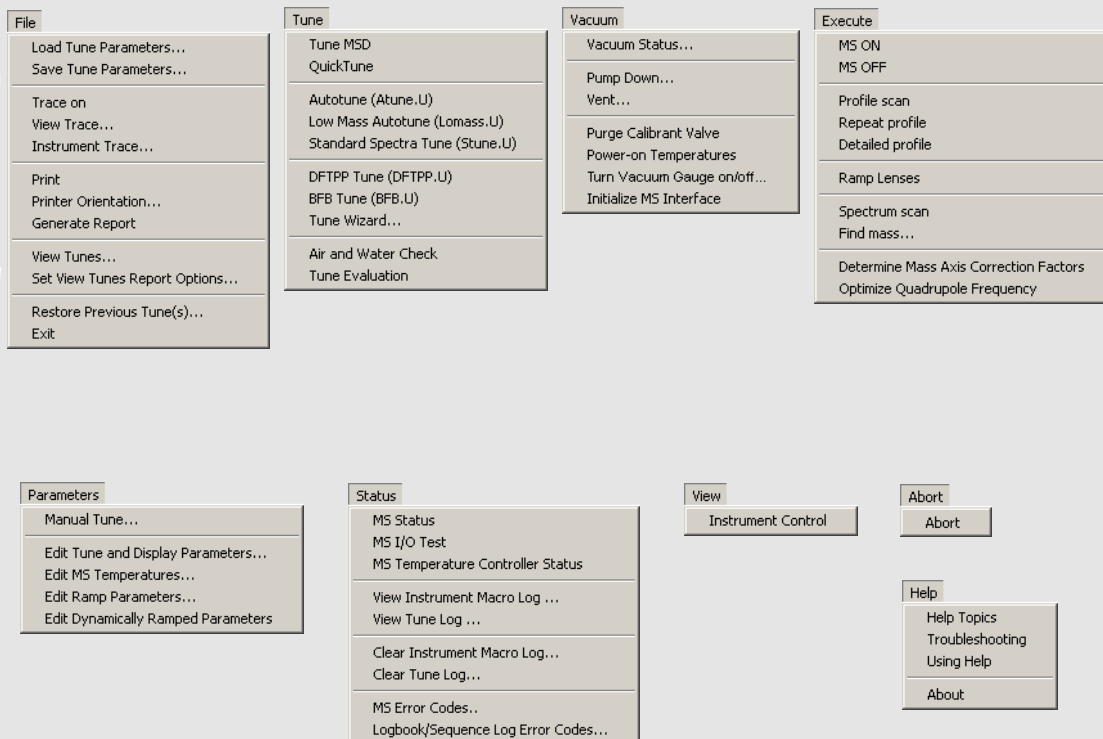

Tune and Vacuum Control Menus - CI Mode

Select **View/Tune and Vacuum Control** from Instrument Control to access these menus.

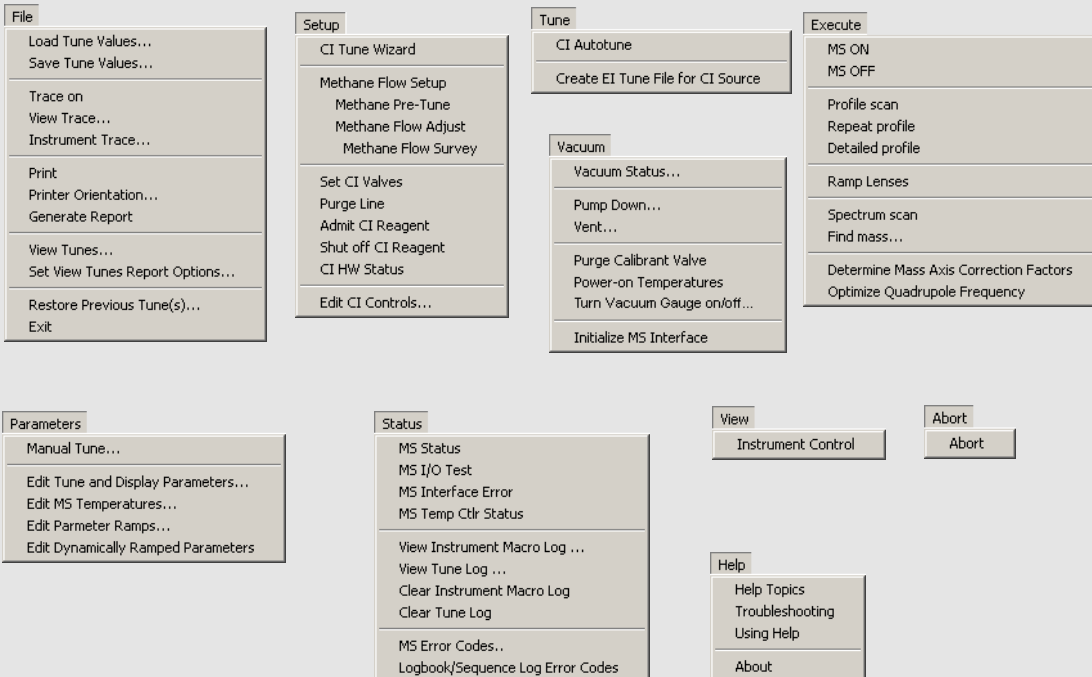

Data Analysis View

The Data Analysis view is displayed when you start a data analysis instrument session or by selecting **View/Data Analysis (offline)** from an Instrument Control view. Use the Data Analysis view to perform tasks such as:

- Setting up integration parameters
- Calibrating a method
- Quantitating data
- Customizing and printing reports

NOTE

See the online help for more details on the menus, buttons, or windows used in the software.

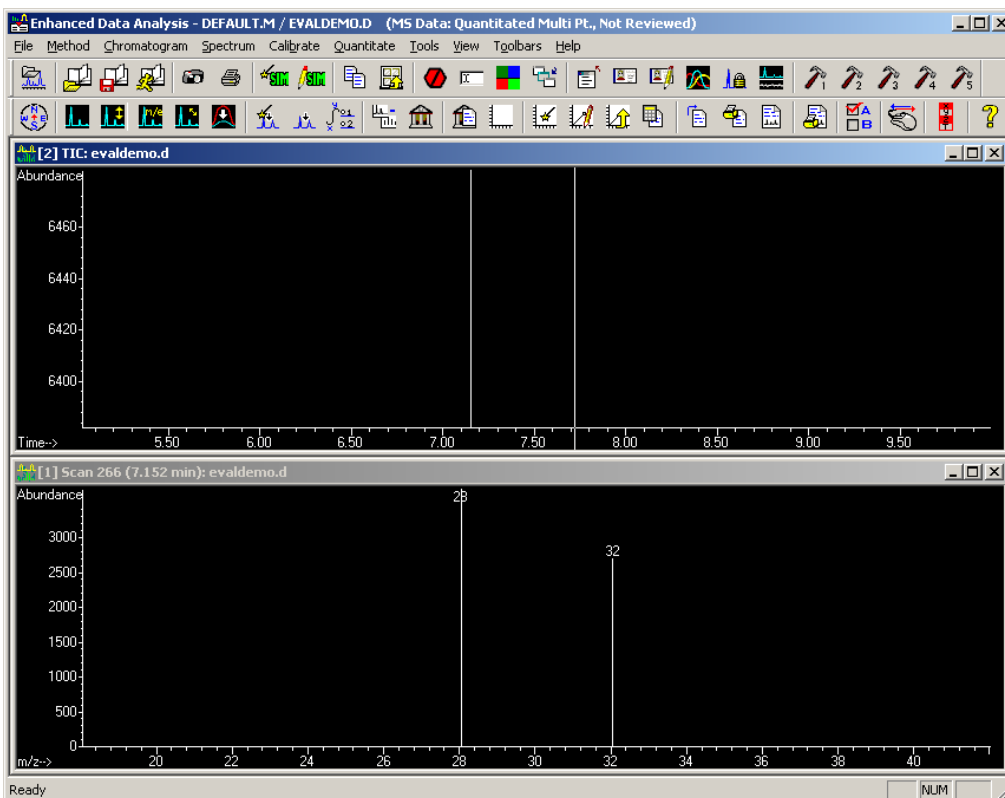

Data Analysis Toolbar Buttons



Load Data File

Loads the selected data (.D) file and displays the total ion chromatogram (TIC) for that file.



Load Method

Lets you choose a method file (*.M) to load from a directory tree.



Save Method

Saves any changes made to the current method.



Run Method

Carries out only the Data Analysis portion of the current method. You must choose an output file name to print. This output file will specify the name of the file that will store the document. The document is stored in a format readable by the printer, not the program you are using to print.



Snapshot

Displays data that has been acquired up to when the snapshot is activated. This feature is not available for GC-only data.



Print

Lets you print the selected window, the TIC and spectrum, or the current method.



Generate AutoSIM Method

Opens the AutoSIM Setup dialog box.



Edit SIM Parameters

Lets you edit the SIM parameters in the SIM Group Table.



Copy

Lets you copy the selected window to the clipboard.



Reset Windows

Rearranges the graphics windows to the default positions.



Abort

Stops a command or macro.



Command Line

Toggles the display of the command line on or off.



Edit Colors

Lets you adjust the colors of various display items in Data Analysis.



Iconize/Restore Graphics

Lets you minimize or maximize the displayed graphics windows.



Close Screen Reports

Closes any open screen reports.



EasyID

Lets you update expected retention times and ion ratios for MS data in an existing quantitation database on a compound-by-compound basis.



QEdit

Lets you review and edit quantitation results once a data file has been quantitated.



Peak Purity

Helps you detect overlapping peaks (multiple-component peaks) in your chromatogram (GC/MS only).



Retention Time Lock

Accesses the RTLock Setup view which is used for retention time locking tasks.



Signal-to-Noise

Lets you perform a signal-to-noise check and then display or print the report.



CUSTOM TOOL 1

Lets you run a user-created macro. This macro must first be created and then named CUSTOMTOOL1. See the online help for Using and Writing Macros, and Data Analysis Commands.

**CUSTOM TOOL 2**

Lets you run a user-created macro. This macro must first be created and then named CUSTOMTOOL2. See the online help for Using and Writing Macros, and Data Analysis Commands.

**CUSTOM TOOL 3**

Lets you run a user-created macro. This macro must first be created and then named CUSTOMTOOL3. See the online help for Using and Writing Macros, and Data Analysis Commands.

**CUSTOM TOOL 4**

Lets you run a user-created macro. This macro must first be created and then named CUSTOMTOOL4. See the online help for Using and Writing Macros, and Data Analysis Commands.

**CUSTOM TOOL 5**

Lets you run a user-created macro. This macro must first be created and then named CUSTOMTOOL5. See the online help for Using and Writing Macros, and Data Analysis Commands.

**Hide/Show Navigation**

Toggle icon that lets you show or hide the Explorer pane.

**Draw Chromatogram**

Redraws the original chromatogram of the current data file without labels or integration marks.

**Scale Chromatogram**

Scales the selected chromatogram by the specified scale factors.

**Ion Chromatograms**

Extracts and displays extracted ion chromatograms (EICs) from the total ion chromatogram (TIC) of the current data file (GC/MS only).

**Merged Format**

Causes EICs to be displayed overlaid on each other (GC/MS only).

**Overlay Chromatograms**

Allows you to select multiple chromatograms to be displayed superimposed on each other.



Autointegrate

Tries to find the best integration parameters for the current chromatogram and then integrates the chromatogram. This action is not allowed if the RTE integrator is currently set in the method.



Integrate

Integrates the current chromatogram using parameters set for the current integrator.



Integration Parameters

Opens a dialog box for editing current integrator's parameters or events.



Subtract

Subtracts one spectrum from another and displays the difference.



Select Library

Displays the Library Search Parameters dialog box where you can select the libraries that will be used for PBM searches of the currently selected spectrum.



Library Search Report

Integrates the current TIC, searches the current library for matches for each peak, and generates a report.



Set Up Quant

Lets you set up a quantitation database by specifying quantitation database globals and entering compounds in the database.



AutoQuant

Provides a semi-automated way to create a quantitation database.



Edit Compounds

Allows you to review and edit information in the quantitation database compound-by-compound.



Update Calibration

Lets you add, delete or update a calibration level in the current quantitation database.



Calc Quant Report

Quantitates the current file and generates a quantitation report.

**Generate Quant Report**

Generates a quantitation report for a file that has already been quantitated.

**Print Quant Report**

Prints the quantitation report.

**Custom Reports**

Starts the Custom Reports software. If the method does not have a quantitation database, or no data file is loaded, you can use default values.

**Print Custom Report**

Prints the custom report template specified by the method, using the current data file.

**Data Analysis Options**

Opens the Select DA Options dialog box.

**Switch Data Analysis Mouse Actions**

Toggles the right-click functionality of the mouse from traditional actions to the new right-click menu options.

**Show/Hide Stack (Variable Watch)**

Lets you choose to show or hide the stack (variable watch) window.

**Online Help**

Displays the GC/MSD ChemStation online help.

Data Analysis Menus

Select **View/Data Analysis (offline)** to access these menus.

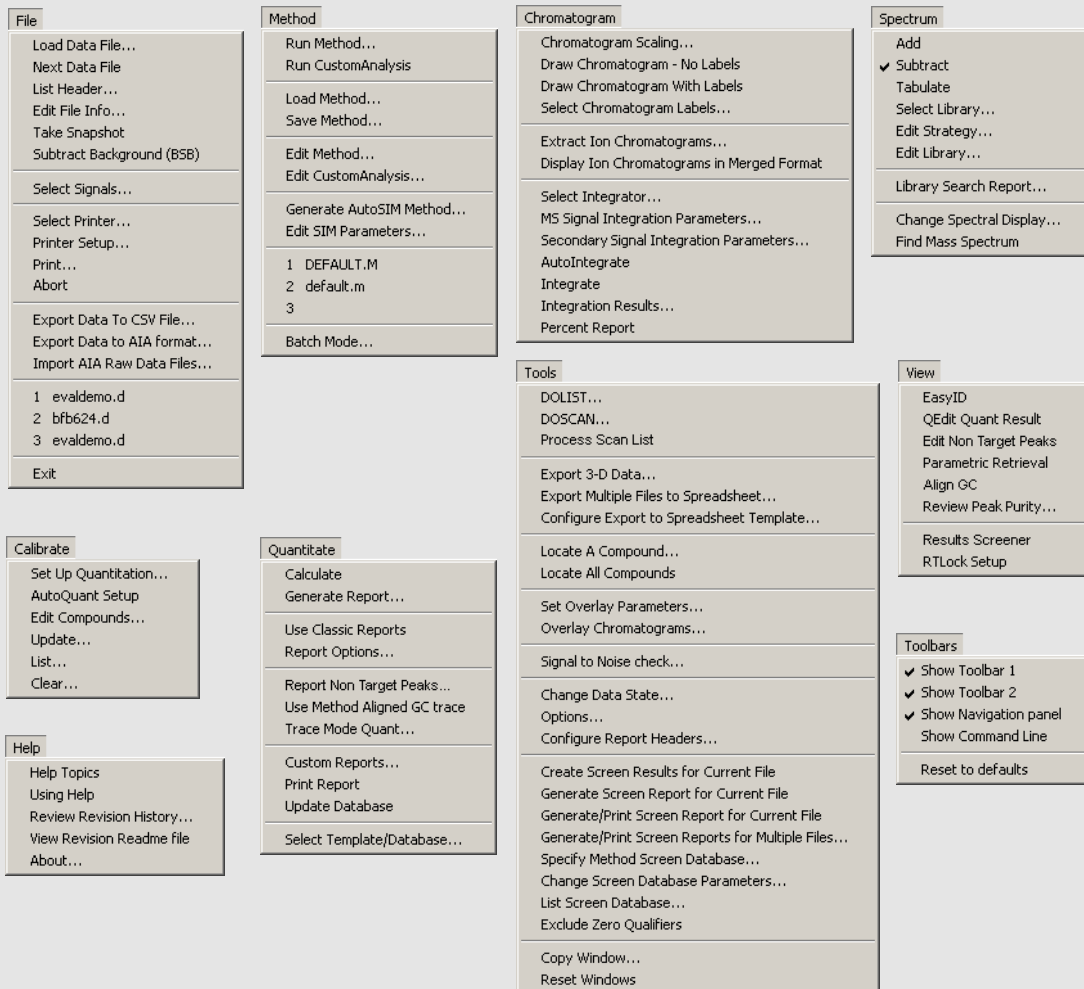

The View menu in Data Analysis lets you access other utilities within Data Analysis (shown on the following pages).

EasyID Menus

Select **View/EasyID** in Data Analysis to access these menus.

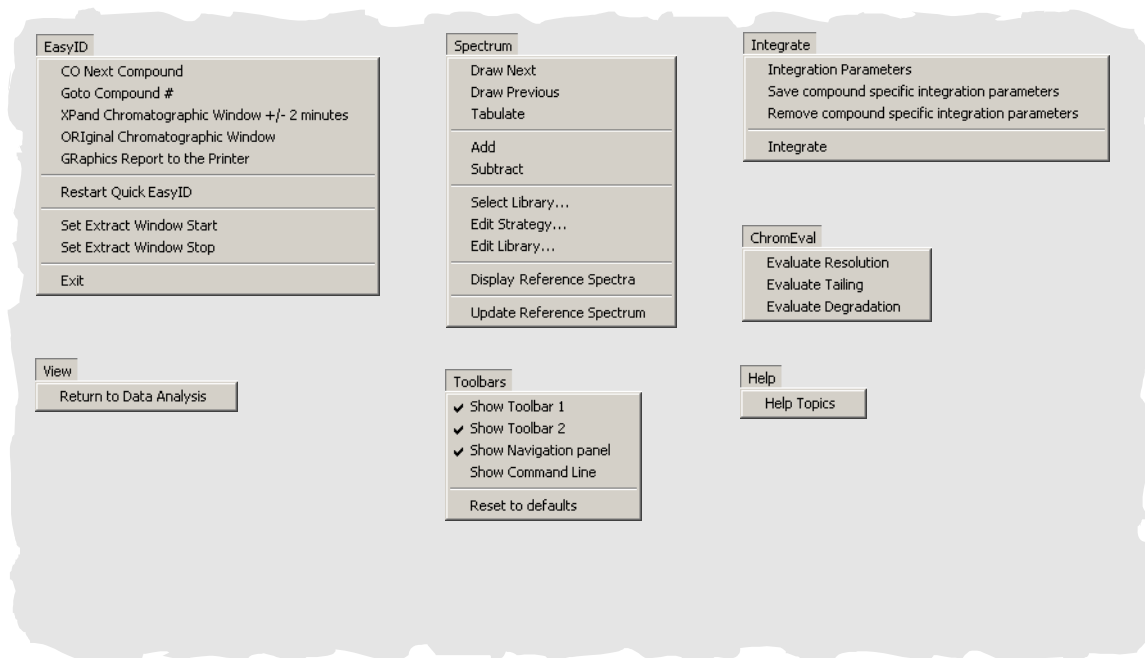

QEdit Quant Result Menus

Select **View/QEdit Quant Result** in Data Analysis to access these menus.

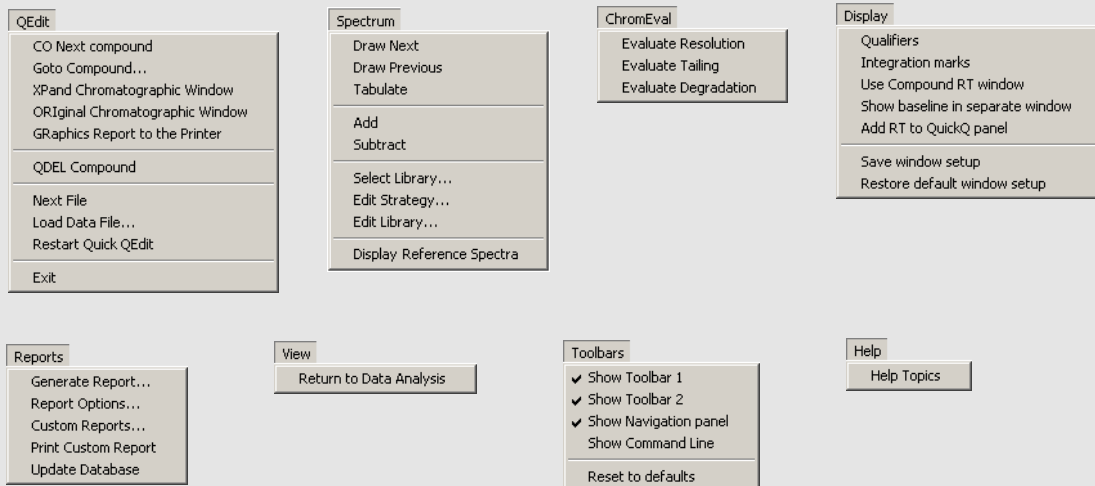

Parametric Retrieval Menus

Select **View/Parametric Retrieval** in Data Analysis to access these menus.

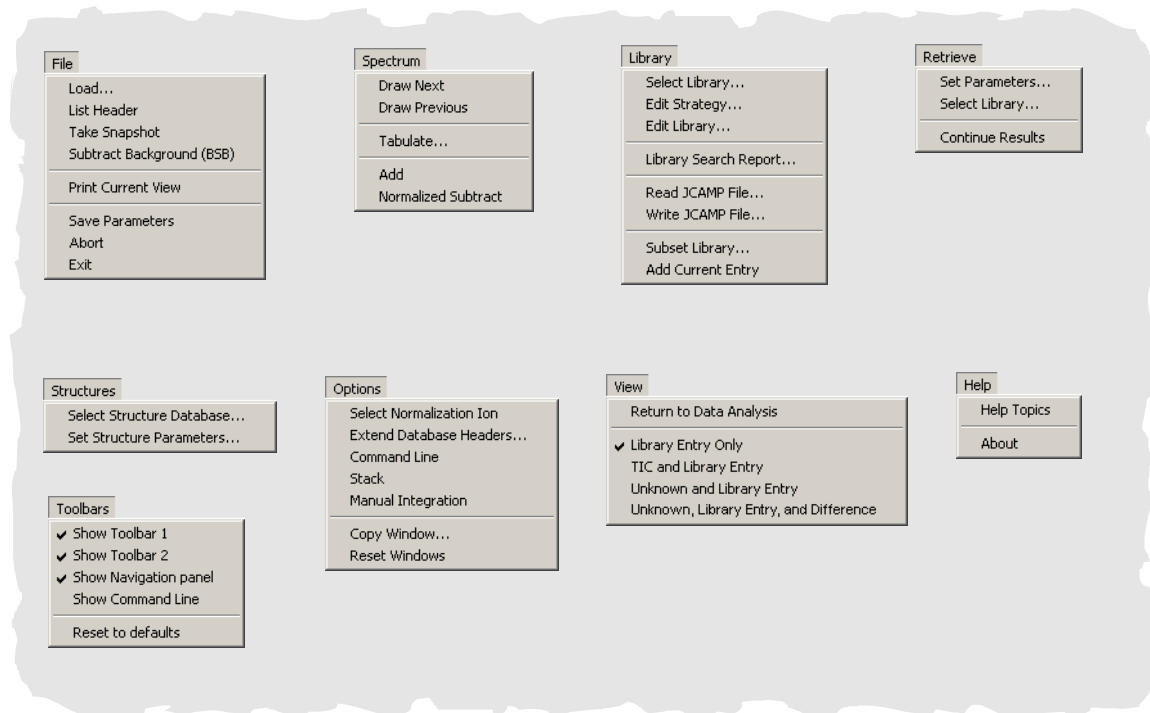

Align GC Menus

Select **View/Align GC** in Data Analysis to access these menus.

Alignment

- Show current Method alignment points
- Show current Setup alignment points
- Perform Alignment
- Save alignment points
- Restore Alignment chromatograms

- Remove Method alignment points
- Exit

View

- Individual Aligned Chromatograms
- Merged Aligned Chromatograms
- Return to Data Analysis

Review Peak Purity Menus

Select **View/Review Peak Purity** in Data Analysis to access these menus.

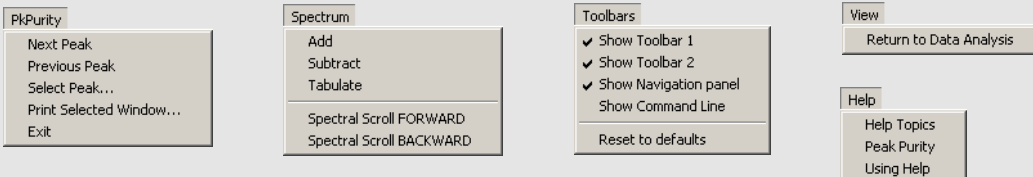

Results Screener Menus

Select **View/Results Screener** in Data Analysis to access these menus.

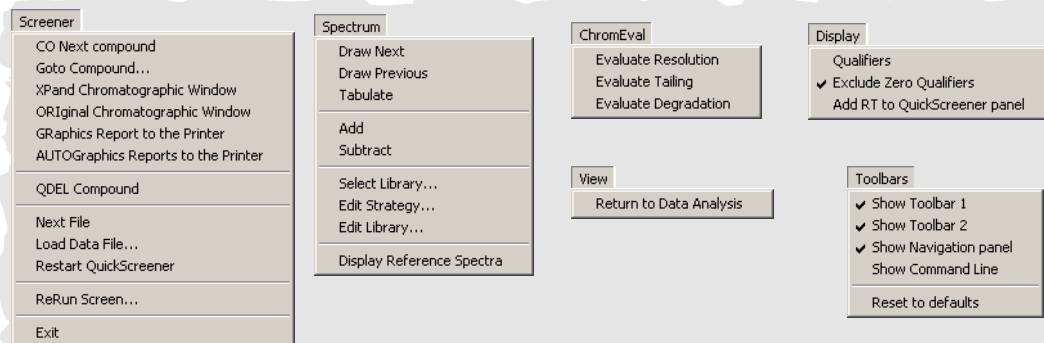

RTLock Menus

Select **View/RTLock Setup** in Data Analysis to access these menus.

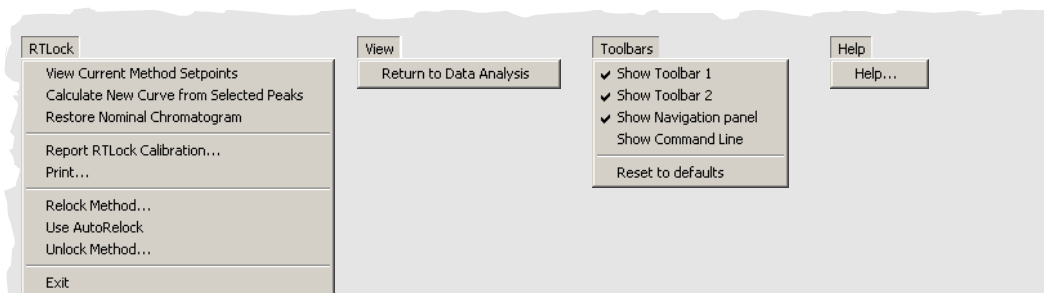

Common ChemStation Tasks

To Pump Down (Start Up) the MSD

- 1 Make sure your system meets all of the following conditions before you pump down:
 - The vent valve is closed (the knob is turned all the way clockwise).
 - All other vacuum seals and fittings are in place and fastened correctly. (The front side plate screw *should not be tightened.*)
 - The MSD is connected to a grounded power source.
 - The GC/MSD interface extends into the GC oven.
 - A conditioned capillary column is installed in the GC inlet and in the GC/MSD interface.
 - The GC is on, but the heated zones for the GC/MSD interface, the injection port, and the oven are off.
 - Carrier gas of at least 99.999% purity is plumbed to the GC with the recommended traps.
 - If hydrogen is used as carrier gas, carrier gas flow is off and the front sideplate thumbscrew is loosely fastened.
 - The foreline pump exhaust is properly vented.

WARNING

Make sure your MSD meets ALL the conditions listed above. Failure to do so can result in personal injury.

- 2 Select **View/Tune and Vacuum Control**.
- 3 Select **Vacuum/Pump Down**.
- 4 When prompted, switch on the MSD.
- 5 Engage sideplate to manifold using handpressure.
- 6 Load instrument control menu.

- 7 Press lightly on the side board to ensure a correct seal.

The foreline pump will make a gurgling noise. This noise should stop within a minute. If the noise continues, there is a *large* air leak in your system, probably at the side plate seal, the interface column nut, or the vent valve.

- 8 Once communication with the PC is established, click **OK**. Within 10 to 15 minutes the diffusion pump should be hot, or the turbo pump speed up to 80%. The turbo pump should eventually reach at least 95%.

CAUTION

If these conditions are not met, the foreline pump will be shut off. You must then power cycle the MSD. If the MSD does not pump down correctly, see the online help for information on troubleshooting air leaks and other vacuum problems.

- 9 When prompted, turn on the GC/MSD interface heater and GC oven. Click **OK** when you have done so. The software will turn on the ion source and mass filter (quad) heaters. The temperature setpoints are stored in the current autotune (*.u) file.

CAUTION

Do not turn on any GC heated zones until carrier gas flow is on. Heating a column with no carrier gas flow will damage the column.

- 10 After the message **Ok to run** appears, wait 2 hours for the MSD to reach thermal equilibrium.

CAUTION

Data acquired before the MSD has reached thermal equilibrium might not be reproducible.

CAUTION

If using a toxic gas, for example ammonia, tighten the MSD side plate screws. Tightening these screws before reaching vacuum can distort the seal and cause leakage.

To Vent (Shut Down) the MSD

- 1 If your 5975 Series MSD is equipped with a vacuum gauge controller, from the Tune and Vacuum Control view select **Vacuum/Turn Vacuum Gauge on/off**. For your 5973 Series MSD make sure your external Ion Gauge Controller is turned off.
- 2 Turn the gauge off.
- 3 Before venting a 5973 series CI MSD, press [Gas Off]. This turns off the reagent gas flow and closes the isolation valve.

WARNING

On a 5973 CI MSD, the Gas Off light must be on when the MSD is venting.

- 4 From the Tune and Vacuum Control view, select **Vacuum Menu/Vent**. Follow the instructions presented.

WARNING

If you are using hydrogen as a carrier gas, the carrier gas flow must be off before turning off the MSD power. If the foreline pump is off, hydrogen will accumulate in the MSD and an explosion may occur. Read the Hydrogen Carrier Gas Safety Information in your manual (5955-5398) before operating the MSD with hydrogen carrier gas.

CAUTION

Be sure the GC oven and GC/MSD interface are cool before turning off carrier gas flow.

- 5 When prompted, turn off the MSD power switch.
- 6 Unplug the MSD power cord.
- 7 Remove the analyzer cover (5973 series) or the source view window cover (5975 series).
- 8 Turn the vent valve knob counterclockwise only three-fourths turn or until you hear the hissing sound of air flowing into the analyzer chamber.

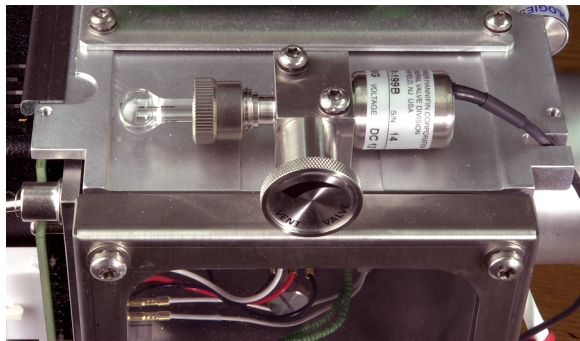

5975 Vent valve

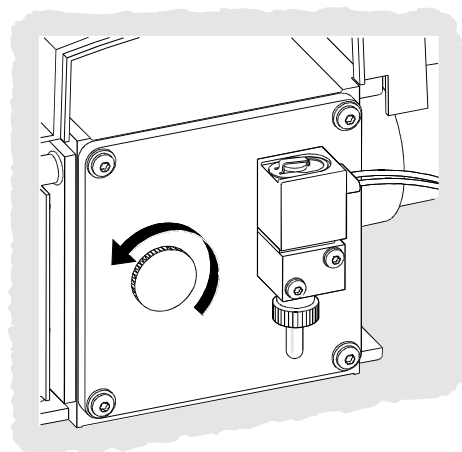

5973 Vent valve

CAUTION

Do not turn the knob too far, or the O-ring may fall out of its groove. Be sure to retighten the knob before pumping down.

WARNING

Allow the analyzer to cool to near room temperature before touching it.

CAUTION

Always wear the clean gloves supplied in the ship kit while handling any parts that go inside the analyzer chamber.

To Tune your MSD

You should tune the MSD periodically to maintain its optimum performance. Tuning is the process of adjusting MSD parameters so the instrument meets certain performance criteria. How often you should tune is determined by the number and type of samples you are running, as well as the overall condition of your system.

NOTE

Always tune the MSD with the same GC oven temperature and column flow, and the same analyzer temperature that will be used for data acquisition.

Keep the Tune reports in a notebook so that successive reports can be easily compared.

To tune the MSD

From the Instrument Control view:

- 1 Select the **Tune Parameters** icon (displays only the first two menus listed in step 2) or **View/Tune and Vacuum Control**.



- 2 From the Tune menu select one of the following, depending on the instrument performance required by your application.
 - Tune MSD**
Results in maximum sensitivity over the full scan range.
 - QuickTune**
Adjusts the peak width, mass assignment, and abundance without changing ion ratios.
 - Autotune (Atune.U)**
Tunes for maximum response over full scan range.
 - Low Mass Autotune (Lomass.U)**
Tunes for the low-mass range.
 - Standard Spectra Tune (Stune.U)**
Results in a standard response over the full scan range. This option may reduce sensitivity.

- DFTPP Tune (DFTPP.U)**
Tunes specifically for the EPA method 625.
- BFB Tune (BFB.U)**
Tunes specifically for the EPA method 624.
- Tune Wizard. . .**
Displays a series of dialog boxes that let you set abundance ratio targets and adjust tuning criteria. This is used for target tuning.
- Air and Water Check**
Generates a standardized measurement and report of the system air (nitrogen m/z 28) and water (m/z 18) levels relative to PFTBA mass 69. Use this item to check for leaks. The abundance of m/z 28 should be less than that of m/z 18, and each should be less than 5% of m/z 69.
- Tune Evaluation**
Evaluates the current tune file.

3 Review the Tune report.

4 To view the history of tune results, select **Tune/View Tunes**.

To use manual tune

Manual tuning lets you interactively set the MSD parameters, such as lens voltages and tuning masses, to values that meet the needs of your particular analysis. Using manual tuning you can often obtain greater sensitivity than you can with autotune.

Manual tuning allows you to ramp individual parameters and to specify the range and step size for the ramp. The results of the ramp are displayed visually with the optimum value for the parameter clearly marked on the plot.

You can acquire two types of data in manual tune: profile scans (plots the abundance and peak shape of the tune masses) and spectrum scans (scans plot response across the entire mass range).

See the online help for more details about manual tuning.

To Acquire Data

To set up the GC for use with the MSD

In the Instrument Control view:

- 1 From the Instrument menu select **Inlet/Injection Types**. Select the appropriate injection source and select the **Use MS** checkbox. Click **OK**.
- 2 From the Instrument menu select **Edit GC Parameters**.
- 3 Click **Aux**. Verify that you are using auxiliary channel 2, the heater is on and set to the desired temperature, and that *MSD* is selected as the Type.
- 4 Click **Columns**. Verify that the detector is *MSD* and that *Vacuum* is selected for Outlet psi. Click **OK**.

To inject a sample with the autosampler

In the Instrument Control view:

- 1 Place the autosampler vial containing the sample into the autosampler tray.
- 2 Click the **Run Method icon** or select **Method/Run Method**.
- 3 When the Start Run box appears, specify the sample information:
 - Specify a unique data path for the sample.
 - Specify a unique data file name for the sample.
 - Enter the position number of the sample vial in the **Vial** field (1–100).
 - (Optional) Fill in the **Operator Name**, **Sample Name**, and **Misc Info** fields to document the injection.
 - Make sure that the *Data Acquisition* option is selected. Select the **Data Analysis** option if you want to generate any of the reports specified in the method.
- 4 Click **Run Method** to initiate the run.

CAUTION

Do *not* use **Start** on the GC to start a run when using the autosampler.

To inject a sample manually

In the Instrument Control view:

- 1 From the Instrument menu select **Inlet/Injector Types**.
- 2 In the Inlet and Injection Parameters dialog box, select **Manual** as the injection source.
- 3 On the GC keypad, press [Prep Run]. This cancels the gas saver flow, brings the inlet flow to its setpoint value, and closes the purge valve (for splitless injection only).
- 4 Select **Method/Run Method**.
- 5 When the Start Run box appears, specify the sample information as described below:
 - Specify a unique data path for the sample.
 - Specify a unique data file name for the sample.
 - (Optional) Fill in the **Operator Name**, **Sample Name**, and **Misc Info** fields to document the injection.
 - Make sure that the *Data Acquisition* option is selected.
 - (Optional) Select the **Data Analysis** option if you want to generate any Data Analysis reports specified in the method.
- 6 Click **Run Method** to initiate the run. If the temperatures are stable, the Prepare To Inject box appears. Otherwise, the message **Waiting for GC ready** is displayed.
- 7 When the GC temperatures have stabilized (6890 GC - the Pre Run light on the GC is steady, 6850 GC - the Not Ready light is off), inject the sample and press [Start] on the GC.

CAUTION

Do not inject before the GC is ready. This will cause inconsistent results.

To Analyze MS Data

You can load a data file from the **Navigation panel** or by selecting **Load Data File** in Data Analysis view.

To load a data file

To load the data file in Data Analysis:

- 1 Select the **Load Data File** icon or select **Load Data File** from the File menu.



- 2 Select a data file (double-click on a file name or type a name and click **OK**). The chromatogram for the data file is loaded and displayed in window [2].

CAUTION

A data file must be loaded to perform any of the tasks in this section.

To integrate a chromatogram

- 1 If the integrator you wish to use is not currently selected, open the Chromatogram menu and click **Select Integrator**. Choose an integrator and click **OK**.
- 2 Select **Chromatogram/Integrate**.
- 3 (Optional) Select **Chromatogram/Integration Results**. A report of tabulated results is displayed on the screen. When you are finished viewing the results, click **Close**.

To select a spectrum

NOTE

If right clicking the mouse in window [1] or [2] displays a menu, use the **Switch Data Analysis Mouse Actions** button to toggle between right-click modes.

Double-click the *right* mouse button on the time point of interest in the chromatogram. The spectrum appears in window [1].

To zoom in

- 1 Position the pointer at one corner of the area you wish to expand in a chromatogram or spectrum.
- 2 Press and hold the *left* mouse button while dragging the mouse to select the area you wish to expand.
- 3 Release the mouse button. The selected area expands to fill the existing window.

To zoom out

- 1 Position the mouse anywhere in the zoomed window.
- 2 Double-click the *left* mouse button.

To average spectra

- 1 Position the pointer in the chromatogram at the starting time for the range you want to average.
- 2 Press the *right* mouse button while dragging the mouse to the end of the range you want to average.
- 3 Release the mouse button. The spectra in the selected range are averaged and the averaged spectrum is displayed in window [1].

To add two spectra

- 1 Select a spectrum (double-click the *right* mouse button in the chromatogram).
- 2 Select a second spectrum (double-click the *right* mouse button in the chromatogram).
- 3 Select **Spectrum/Add**. The two spectra are added together and the resulting spectrum is displayed in window [1].

To subtract two spectra

- 1 Select a spectrum (double-click the *right* mouse button in the chromatogram).
- 2 Select the spectrum to be subtracted (double-click the *right* mouse button in the chromatogram).
- 3 Select **Spectrum/Subtract**.

The spectrum selected in [step 2](#) is subtracted from the spectrum selected in [step 1](#) and the resulting spectrum is displayed in window [1].

To subtract background spectra

- 1 Select a spectrum or average a range of spectra to subtract from the data file.
- 2 Select **File/Subtract Background (BSB)**. The system performs the following tasks:
 - The selected spectrum is subtracted from every scan in the current data file.
 - The subtracted data is stored in a BSB subdirectory in the same directory as the data file.
 - The subtracted data file becomes the current data file and is displayed in window [2].

To Use Spectral Libraries

To select a library

- 1 In Data Analysis, select **Spectrum/Select Library**.
- 2 In the **Library Search Parameters** dialog box enter the name of the Library on the first line.

Up to two additional Search libraries may be entered. Searching in these additional libraries is dependent on a compound being found meeting the match quality specified.

To integrate and search peaks

Use the following procedure to integrate a total ion chromatogram and automatically generate a library search report for each peak detected.

- 1 In Data Analysis, load a data file. The TIC is displayed.
- 2 Select **Spectrum/Library Search Report**.
- 3 When the **Library Search Report Options** dialog box appears, select the options you want for the library search report:
 - Select either **Summary** or **Detailed** to determine the report format.
 - Select one or more destinations (**Screen**, **Printer**, and **File**).
 - Select an **Integration Parameter File** (leave the field blank to autointegrate using the GC/MSD ChemStation integrator).
 - Select which spectrum from each peak to use (**Apex**, **Apex - Start of Peak**, **Apex - Background at time**, or **Peak Average**).
- 4 Click **OK** to initiate the search.

The chromatogram is integrated and a spectrum from each peak is searched. The results of the integration appear on the screen. The library search report is sent to the destinations selected in [step 3](#).

- 5 Select **Chromatogram/Integration Results** to view the tabulated integration results.

To search a single spectrum

- 1 In Data Analysis, load a data file.
- 2 Select a **spectrum**.
- 3 Double-click the right mouse button in the window containing the spectrum.

NOTE

If right clicking the mouse in window [1] or [2] displays a menu, use the **Switch Data Analysis Mouse Actions** button to toggle between right-click modes.

When the search is complete, the search results appear on the screen. The spectrum for the unknown, the reference spectrum you select from the list of hits, and, if available, the chemical structure of the reference compound is displayed.

- 4 To view other spectral data:
 - Click another compound in the hit list to display a different reference spectrum.
 - Select the **Difference** checkbox to display the difference between the unknown and the reference spectra.
- 5 To view other information:
 - Click **Statistics** to display information about the quality of each hit found in the list.
 - Click **Text** to view the header information stored in the library for the current reference spectrum.
- 6 Click **Print** to print a copy of the displayed spectra.
- 7 Click **Done** to clear the library search results from the screen.

To Use Retention Time Locking

Retention time locking (RTL) is a procedure that evaluates characteristics of a particular method (column, flow setpoints, oven parameters) so that any changes to the column, which would normally impact retention times, are negated. The procedure involves collecting data for a compound (whose desired retention time is known) at various inlet pressures

around the current method setpoint (-20%, -10%, nominal, +10%, +20%). The five resultant runs are then evaluated and a pressure/retention time curve is generated to characterize that particular instrument. From the curve, a predicted pressure which causes the lock compound to elute at the desired time can be calculated and stored so that the method will run at that pressure.

To lock an MS method

- 1 From Instrument Control, load the method you want to lock. Edit the method parameters, if necessary.
- 2 For ALS injections, put the vial in position 1.
- 3 Select **Instrument/Acquire RTLock Calibration Data**. This initiates the collection of the RTL calibration files.
- 4 The nominal pressure will be evaluated for the calibration range of -20%, -10%, +10% and +20%, and five runs will be made automatically. You are prompted that the five runs will be made, and if any previous calibration data exists, you are alerted to this fact as well. The five data files will be stored in the method directory under a folder named RTLOCK with the data file names of RTLOCK1 - RTLOCK5.
- 5 Following data collection, a new session of Data Analysis will be initiated, and the nominal run (RTLOCK3.D) will be loaded. Select the peak (click and drag right mouse button) you want to use for RTL calibration calculations.
- 6 The spectrum of the selected peak will be displayed. Click **Yes** to have the software automatically locate the lock compound peak in the remaining four runs. The software will now perform spectral comparisons and curve fit determinations. The five selected peaks are then displayed.
- 7 The curve equation (based on the retention time vs. pressure values) is displayed and you are asked if you want to continue. Click **Yes**.
- 8 Next, enter the lock retention time you want to use and click **OK**.

- 9 Click **Yes** to save the lock pressure information to the method. Enter the lock compound name you want to use and click **OK**.
- 10 You are now given the option to delete the calibration data files (RTLOCK1.D - RTLOCK5.D). Select **Yes** or **No**. The method is now locked.

Whenever a locked method is loaded into Instrument Control, the title bar will indicate that the method is locked, and which compound was used for the lock. The pressure (online instruments only) will be set to the locked pressure.

NOTE

When a locked method is run, the pressure is restored to the locked pressure value EVEN if you have made changes using the GC keypad or from Instrument Control.

Maintenance Schedule

Detailed maintenance tasks are described in the hardware manuals supplied with your system. How often you need to perform system maintenance may vary for your system. Keep a maintenance record.

Every day

- Check, and if necessary, replace the septum.
- Check the tightness of the injection port liners.
- Check the tightness of the column nuts.

Every week

- Check the foreline pump fluid level.
- Change the injection port liners and O-rings.

Every month

- Clean the split/splitless inlet vent line trap.
- Check for leaks (inlet, column connections).

Every 3 months

- Replace gas cylinders (when below 500 psig).

Every 6 months

- Replace the foreline pump fluid.
- Check, and if necessary, refill the calibration vial.

Every year

- Check, and if necessary, replace the diffusion pump fluid.
- Recondition or replace internal and external traps and chemical filters on the GC.

As needed

- Tune the MSD.
- Clean the ion source.
- Replace the carrier gas trap.
- Replace worn out parts (filaments, EM, etc.).
- Replace the column.
- Lubricate seals.

Safety warnings**WARNING**

Do not perform maintenance with the MSD on or connected to its power source unless specifically instructed to by documentation supplied with the MSD.

The GC/MSD interface can be on and at a dangerously high temperature even though the MSD is off. After it is turned off, the GC/MSD interface cools very slowly. Make sure all parts have cooled before handling them.

Be careful when working behind the GC. During cool-down cycles, the GC will emit hot exhaust that could cause burns.

The oil trap provided for your foreline pump stops only foreline pump oil. If you are analyzing toxic chemicals or using toxic solvents, remove the oil trap and use a hose to route the foreline pump exhaust out of your laboratory.

Use chemical-resistant gloves and safety glasses when replacing pump fluid. Avoid all contact with the fluid.

The insulation around the inlets, detectors, valve box, and insulation cups is made of refractory ceramic fibers (RCF). Avoid inhalation of RCF particles. Ventilate your work area, wear long sleeves, gloves, safety glasses, and a disposable respirator. Dispose of insulation in a sealed plastic bag. Wash your hands with soap and cold water after handling RCFs.

Operating Tips

- Back up your data and methods *regularly*.
- Make sure the tune file you are using is appropriate for your samples.
- Save Tune reports in a notebook for future reference.
- Perform system maintenance as indicated by the maintenance schedule in the GC and MSD hardware documentation. Keep a record of all maintenance performed.
- When venting the MSD, take advantage of the cool GC to do maintenance such as replacing inlet liners, septa, etc.
- After pumpdown, wait *at least 2 hours* for the MSD to reach thermal equilibrium before tuning or acquiring data.
- Optimum sensitivity generally occurs at column flow rates of 1.2 mL/min or less.
- When injecting volumes greater than one microliter, use the pulsed splitless mode and increase the initial oven temperature 10–20°C.
- For splitless injections, pulsed splitless mode gives more quantitative sample transfer onto the column. A pulse pressure of twice the initial inlet pressure is typical.
- Selecting **Constant Flow mode** will provide the most efficient separation in most cases.
- For a new column, check that the column nuts are still tight after the first few oven temperature cycles.
- Use the [Config Status] keys on the 6890 GC keypad to set the three display items most important to you (**time remaining**, **oven temp**, etc.). These are then always visible regardless of which GC/MSD ChemStation view is on top.
- Rinse and refill autosampler wash vials. Do not add more solvent to a partially full vial.

- ❑ Use the following table as a guide to using the SIM and/or Scan acquisition modes.

Task	Mode
Analyze a mixture with unknown components.	Scan, or Scan and SIM
Analyze a mixture with known components in unknown amounts (quantitate).	Scan, or SIM, or Scan and SIM
Identify the presence of a few known compounds at low levels within a mixture.	SIM

- ❑ When choosing masses for SIM, use the exact mass printed in the Tabulation report, not the nominal mass annotated on the spectrum display. This provides more accurate data.
- ❑ When doing SIM analysis, use low resolution mode unless you are trying to determine the ratios of masses one amu apart. Low resolution provides maximum sensitivity and repeatability.
- ❑ Choose the narrowest scan range that still produces good library search results. This allows more spectra across the peak and better quantitation.

Error Messages and Troubleshooting

Error Messages

Sometimes, a problem in your MSD will cause an error message to appear in the GC/MSD ChemStation software. Some error messages appear only during tuning. Other messages will appear during tuning or instrument control.

Sometimes, instead of a message only a number will appear. This number can represent one or more error messages.

To translate a number into an error message:

- 1 Note the number.
- 2 In Instrument Control, select **View/Tune and Vacuum Control**.
- 3 Select **Status/MS Error Codes**.
- 4 Type the error number in the box provided and click **OK**.

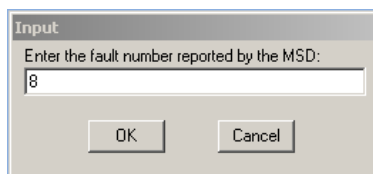

The corresponding error message(s) will be displayed.

```
File  Tune  Vacuum  Execute  Parameters  Status  View  Abort  Help
MS Error code   8
( See Help -> Troubleshooting )

There is no emission current.
```

Troubleshooting Tips

MSD LAN error

MSD is on, but status flashing "Server not found! Check LAN connection"

This is normal when the MSD is initially turned on. It means the GC/MSD ChemStation has not yet established contact with the MSD. If the flashing continues after the pumpdown is initiated:

- Temporary power failure interrupted communications.
- Bad connection between the MSD and the GC/MSD ChemStation and/or the Agilent Bootp service and/or the switch/hub.
- MAC and IP addresses for the MSD are not properly configured in the Agilent Bootp service for the LAN.

Baseline rising

- Column bleed
- Other contamination

Foreline or vacuum manifold pressure too high

- Excessive column flow
- Air leak
- Diffusion pump fluid level too low
- Diffusion pump fluid is contaminated
- Foreline pump oil level too low
- Foreline pump oil is contaminated
- Constricted foreline hose (this would cause the vacuum manifold pressure to be too high but the foreline pressure to be too low)

High background in mass spectra

- Air leak
- Foreline or vacuum manifold pressure too high
- Other contamination

Ions at m/z 18, 28, 32, and 44

- Detector vented recently (residual air and water)
- Air leak

Isotopes missing or isotope ratios incorrect

- Incorrect tuning
- Dirty ion source
- High background
- Electron multiplier voltage too high
- Repeller voltage too high
- High scan speed (Scan mode)
- Low dwell time (SIM mode)
- Peaks too wide or too narrow
- Repeller and ion focus leads have been reversed

No peaks

- Incorrect sample concentration
- No analytes present
- Syringe missing or not installed correctly (ALS only)
- Empty sample vial
- Injection in split mode instead of splitless mode

Peaks tailing

- Active sites in sample path
- Injection too large
- Injection port too cool
- Column flow too low
- GC/MSD interface or ion source too cool

Peaks with flat tops

- Solvent delay time too short
- Display scale is wrong
- Injection too large
- Electron multiplier voltage too high

Peaks with split tops

- Bad injection technique
- Injection too large

Peakwidths inconsistent

- Incorrect tuning
- No PFTBA in calibration vial
- Calibration valve failure
- Dirty ion source
- Worn out electron multiplier
- MSD has not had enough time to reach thermal equilibrium
- Large variations in the temperature of the lab

Poor repeatability

- Dirty syringe needle
- Leaking injection port
- Mismatched injection port liner and injection size
- Loose column connections
- Variations in pressure, column flow, and temperature
- Dirty ion source
- Loose connections in the analyzer
- Ground loop

Poor sensitivity

- Incorrect tuning
- Tune file does not match type of analysis
- Incorrect temperatures
- Incorrect sample concentration
- Leaking injection port
- Incorrect split ratio
- Purge off time in splitless mode too short
- Excessive pressure in the MSD
- Dirty ion source
- Air leak
- Detector is not working correctly
- Poor filament operation
- Incorrect mass filter polarity

Retention time (RT) drift

- Column has been shortened (shorter RT)
- Old column (shorter RT)
- Active sites in sample path (longer RT)

- Reduced column flow (longer RT)
- Injection port leak (longer RT)
- Initial oven temperature changed (up = shorter RT, down = longer RT)

Refer to the Troubleshooting the MSD section of the online help for more detailed information.



2 Understanding Quantitation

Quantitation	66
What is in this chapter	66
Introduction	66
How does quantitation work in the GC/MSD ChemStation?	66
Quantitation Database	69
Introduction	69
How do I manually set up a quantitation database?	71
How does AutoQuant Setup work?	76
Tutorial – Using AutoQuant Setup	77
Procedure: Using AutoQuant Setup to create a quantitation database	78



Quantitation

What is in this chapter

This chapter guides you through the basic steps of creating a quantitation database. These steps are a starting point for becoming familiar with the software.

Once you are comfortable, try the Tutorial at the end of this chapter, then experiment with creating a quantitation database from your own data files. Use the online help for more information about these features and how they work.

Introduction

What does Quantitation do?

Quantitation identifies how much of a compound is in a sample.

When is Quantitation done?

Quantitation is done during the last part of analyzing a sample (after the compound is identified).

How is Quantitation done?

Quantitation is done by comparing the response from an unknown amount of compound (the data extracted from a run) with the response from a measured amount of the compound (which is stored in the quantitation database).

The quantitation database will be discussed later on in this document.

How does quantitation work in the GC/MSD ChemStation?

The following describes, in very general terms, how the ChemStation determines how much of a compound is in a sample. It is a two part process.

Part 1 -- Data Acquisition

The first part of the process involves *data acquisition*, briefly described below.

When you place an unknown sample into the GC/MSD, broadly speaking, the sample is heated, pressurized, separated into individual components, and finally passed through a detector in the ChemStation. All of this is done according to the method you specify.

The detector sees the unique pattern that comes from each compound, and the ChemStation then compares that pattern to known patterns, which are stored in the library that is associated with your method. If there is a match, the ChemStation will report it.

So, if the pattern of one of the compounds found in your sample matches the pattern of xxx that is stored in the library associated with your method, the ChemStation can report that it found xxx in your sample.

Creating the data acquisition portion of the method is a highly specialized process, and is beyond the scope of this document. Refer to your online help for detailed information on creating methods.

In the tutorial at the end of this document, we will use the default method, demo data file, and demo spectrum library that come with your ChemStation to demonstrate how AutoQuant Setup works.

Part 2 -- Data Quantitation

The second part of the process involves finding out how much of a compound there is in the sample. This is the *data quantitation* portion of the process, which is briefly described below, and is elaborated on in the [Tutorial – Using AutoQuant Setup](#) on page 77.

To determine how much of a compound is in a sample, the ChemStation has to be able to compare what it finds (the unknown amount of xxx) to a known amount of xxx, so it can do a ratio and provide you with an answer.

This is where the quantitation database comes in.

While the library stores patterns of known compounds, the quantitation database stores those plus additional details, such as:

- How the compound responds at specific quantities (for example, 10 ppb)
- The compound's target ion
- The target ion's qualifying ions

So, after the software *identifies* the compound (by comparing it to the library), it can further define *how much* of it there is by comparing the instrument response it found in the unknown sample, to the response listed in the quantitation database.

For example, if the entry in the quantitation database represents 10 ppb, and the amount found in your sample is twice that amount, it must be 20 ppb.

NOTE

This is a greatly oversimplified version of the process. However, this discussion is only intended to convey the general concept of data acquisition and quantitation, not the exact specifics of how it is done.

For setting up the quantitation database, please refer to the [Tutorial – Using AutoQuant Setup](#) on page 77.

Quantitation Database

Introduction

What is a quantitation database?

The quantitation database lists the significant details about each compound you are looking for.

What kind of data is required in the quantitation database?

For each compound you want to quantify, the quantitation database should include:

- One entry that identifies the compound you are looking for, including details such as:
 - Retention time
 - Quantitation parameters
 - Identification selection criteria
 - Method for calculating qualifier ion ratios
 - Acceptable range for the relative response
 - Mathematical treatment applied to calibration data for a compound
 - Data points used in the calibration curve
- One entry that identifies the target ion (usually the base-peak ion) in the compound you are looking for
- Two or more entries for ions that further qualify the presence of the compound. (For example, these ions will always appear with the compound's peak ion and always in the same ratios to it.)
- Any internal standards you will be using

This sounds difficult to do, but AutoQuant Setup can identify these ions for you automatically. See [How do I use AutoQuant to set up a quantitation database?](#) on page 74 for details on how this works.

How big is the quantitation database?

To quantify a single compound, the quantitation database could consist of as little as three entries:

- The compound's base-peak ion
- Two additional ions that qualify the presence of that peak ion

An additional optional entry that many users choose is an internal standard.

The size of the quantitation database will expand according to how many target compounds you want to quantify and how many data points are defined in the calibration curve.

How do I create a quantitation database?

There are two ways to add compounds to the quantitation database:

- Manually
- Semi-automatically using AutoQuant Setup

Both are summarized below.

How do I manually set up a quantitation database?

This section is an overview of the steps involved in setting up a quantitation database manually.

Building the quantitation database manually requires users to visually inspect the chromatogram and individually select each compound, target ion, and qualifying ions of interest, then name them and save them in the quantitation database. (This represents steps 2 through 8 in the [An overview of how to set up a quantitation database manually](#) on page 72.)

Following the discussion on manually setting up a quantitation database, there is a section on how to set up a quantitation database using AutoQuant Setup. AutoQuant Setup is a semi-automatic process in which the software reviews the chromatogram and selects the compounds, target ions, and qualifying ions for you based on their abundance and the library you specified.

Once again, the following two sections include overview information only. Please see the [Tutorial – Using AutoQuant Setup](#) on page 77 for detailed instructions on setting up a quantitation database using AutoQuant Setup.

An overview of how to set up a quantitation database manually

To manually set up a quantitation database, you would complete the following general process.

- 1 Load a data file that contains a measured standard of the compound you want to calibrate and enter the common information for all compounds you will list in your quantitation database on the Quantitation Globals page, and click **OK** when finished. (Select **Calibrate/Set Up Quantitation...** to access the **Quantitation Database Globals** page).

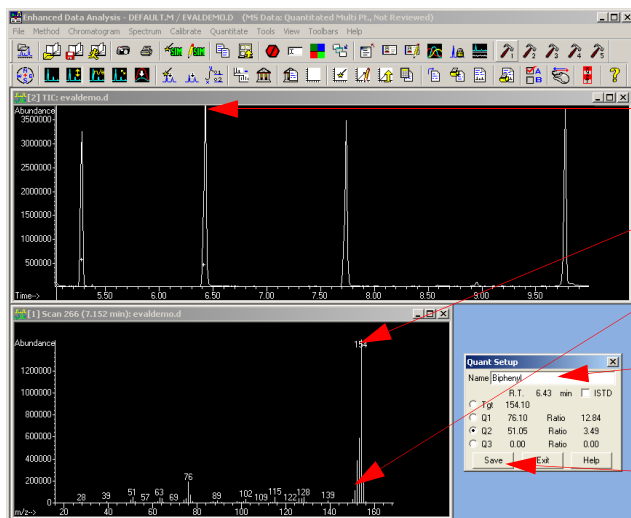
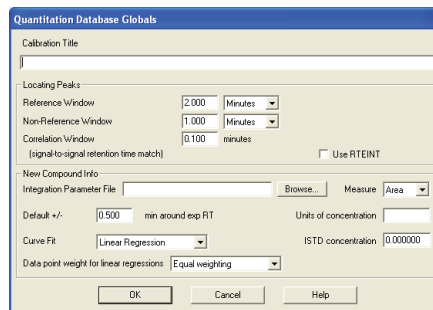

- 2 Manually review the chromatogram generated by the measured sample data file.
- 3 Individually select each compound by clicking on its peak in the chromatogram.
- 4 From the displayed spectrum select a target ion.
- 5 Select qualifying ions for this compound.
- 6 Name the compound, and if this compound is your internal standard, mark a checkbox identifying it as such.
- 7 Save this compound's spectral profile to the quantitation database.
- 8 Repeat steps 2 through 7 for each compound you want to add to the quantitation database.

- 9 Once you have added all the compounds you want, select **Calibrate/Edit Compound...** to see a complete list of the entries you made to the quantitation database (on the **Edit Compounds** screen).

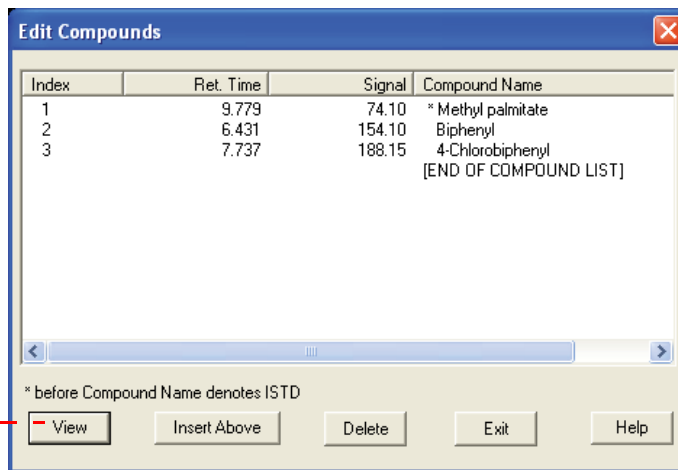

- 10 From the **Edit Compounds** screen you may select any compound then click **View** to display the first page of data saved for that compound. There are three pages of information for each compound, stored as pages 1, 2, and 3 of the quantitation database record.

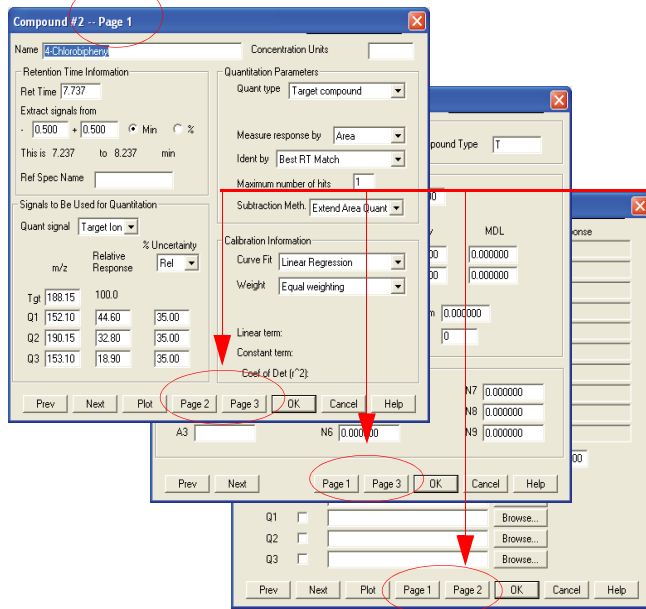

Use the page buttons to toggle among the three screens.

The spectral information and the information you entered on the Globals screen is transferred to these pages.

To finish the process, *manually* update the individual compound screens (Pages 1, 2, and 3) for each of the entries in the quantitation database.

How do I use AutoQuant to set up a quantitation database?

In the manual process, you had to manually review the chromatogram and individually select, name, and save each compound and ion you wanted included in your quantitation database. AutoQuant Setup, however, is a semi-automatic process in which the software reviews the data file and automatically identifies the compounds, target ions, and qualifying ions for you based on their abundance and the library you specified.

An overview of how to set up a quantitation database using AutoQuant

Using AutoQuant Setup to create a quantitation database you would complete the following general process.

- 1 The first step is the same as setting up the quantitation database manually. See [An overview of how to set up a quantitation database manually](#) on page 72 for details.
- 2 Steps 2 through 8 of the manual process involving manually selecting compounds and ions. When you use AutoQuant, however, these steps are automated for you, as described here. After you complete the **Database Globals** screen and click **OK** (in [step 1](#)), the software automatically begins looking for significant peaks in the data file. For each peak it finds, it compares the data with the specified library, and displays the compound on a screen similar to this.

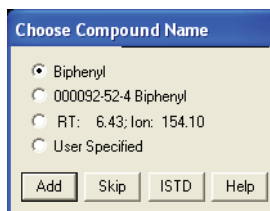

From this screen:

- Add** Adds this *compound*, its *target ion*, and *three qualifying ions* to your quantitation database.
- Skip** Causes the software to display the next compound it found in the data file.
- ISTD** Adds this compound to the quantitation database and identifies it as the internal standard.

NOTE

The ISTD must precede the compounds, etc. and is indicated with an asterisk in the entry list.

- 3** After all compounds found in the data file are presented, you are prompted **Do you want to Quantitate Now?** **Yes** brings up a calibration screen and then the **Edit Compound Screen** where you can see your finished quantitation database. (This is equivalent to [step 9](#) in the manual process.)

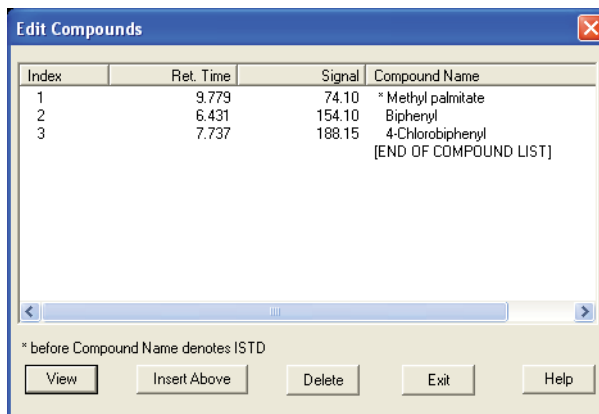

From the **Edit Compounds** screen you can select any compound and click **View** to display the page 1 of the data saved for that compound, exactly as described in [step 10](#) of the manual process.

How does AutoQuant Setup work?

AutoQuant Setup identifies the compounds in your data file using the spectral library you specify and chooses the target ion and qualifying ions for each compound based on their abundance in the compound. Once you agree to the choices, AutoQuant Setup will automatically complete the necessary entries in your quantitation database.

Prerequisite: In order to use AutoQuant Setup, you must have a library that contains your target compounds, and your calibration standard cannot contain co-eluting compounds.

Tutorial – Using AutoQuant Setup

This tutorial will guide you through the steps of using AutoQuant Setup to create a quantitation database. This exercise is intended to illustrate how quickly you can create and use a quantitation database using AutoQuant Setup. It should take you about 5 minutes to complete.

During this exercise you will create a method containing a quantitation database that can identify and quantify Biphenyl, Chlorobiphenyl, and Methyl palmitate.

To do this you will:

- 1 Load the default method **DEFAULT.M** supplied with your ChemStation.
- 2 Load the demo data file **EVALDEMO.D** supplied with your ChemStation.
- 3 Use the demo spectrum library **DEMO.L** supplied with your ChemStation.
- 4 Use AutoQuant Setup to create a quantitation database with the following compounds:
 - Dodecane
 - Biphenyl
 - Chlorobiphenyl
 - Methyl palmitate

The resulting method and quantitation database will be able to identify and quantify Biphenyl, Chlorobiphenyl, and Methyl palmitate.

Procedure: Using AutoQuant Setup to create a quantitation database

- 1 Make a copy of **DEFAULT.M** and **EVALDEMO.D** before using them in this tutorial.
- 2 In *Data Analysis*, load two files:

The demonstration method **C:\MSDCHEM\1\METHODS\DEFAULT.M**

The demonstration data file **C:\MSDCHEM\1\DATA\EVALDEMO.D**

When you do this to create your own quantitation database, this data file is taken from your calibrated sample run.

- 3 Under **Spectrum/Select Library** or click icon: Select **DEMO.L**.

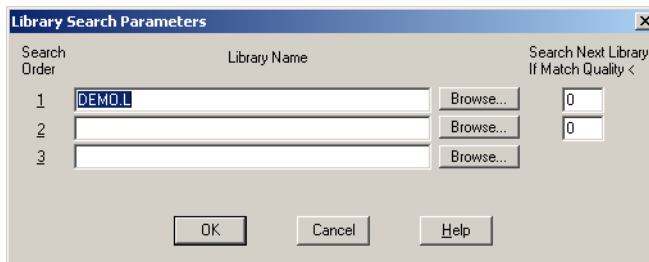

- 4 Select **Calibrate/AutoQuant Setup** or click icon.

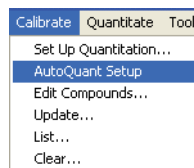

- 5 When the **Quantitation Database Globals** dialog box appears, notice the default information shown (this is from whatever was previously viewed). You may modify this as required for your method.

This screen is called the “globals” because the information here is common information for all compounds and is automatically filled in for each compound you add to the quantitation database.

- 6 For this tutorial, when the **Quantitation Database Globals** dialog box appears, enter the following:
- In the **Calibration Title** field, type **AutoQuant Tutorial**. This line will appear in the title of each quantitative report.
 - Check the **Use RTEINT** box to use the RTE integrator.
 - Click **OK**.

Quantitation Database Globals

Calibration Title
Autoquant Tutorial

Locating Peaks

Reference Window: 2.000 Minutes

Non-Reference Window: 1.000 Minutes

Correlation Window: 0.100 minutes
(signal-to-signal retention time match) Use RTEINT

New Compound Info

Integration Parameter File: Browse... Measure: Area

Default +/-: 0.500 min around exp RT Units of concentration:

Curve Fit: Linear Regression ISTD concentration: 0.000000

Data point weight for linear regressions: Equal weighting

OK Cancel Help

After you click **OK**, the software begins looking for significant peaks in the data file. When it finds the first peak, it compares it with the library specified (in [step 3](#)), and displays the name of the first compound it found in the library. As each compound is displayed, you will determine what you want done with that compound.

- 7 In this case, the first compound it finds is Dodecane. There are three actions you can take on this compound:

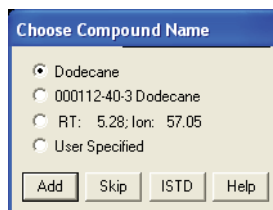

Add Adds this *compound*, its *target ion*, and *three qualifying ions* to your quantitation database.

Skip Causes the software to display the next compound it found in the data file.

ISTD Adds this compound to the quantitation database and identifies it as the internal standard.

When the **Choose Compound Name** dialog box for Dodecane appears, click **Skip**. For demonstration purposes we will skip this compound now. Later on we will rerun this process and add this to the quantitation database then.

When the **Continue peak entry?** box appears, click **Yes**.

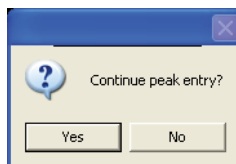

(If you click **No** here, the **Quantitate now?** dialog box is displayed, as shown in [step 11](#).)

- 8 Biphenyl appears next (because it eluted after Dodecane in this sample). Keep the default name and click **Add** to add this compound to the quantitation database.

Choose Compound Name

Biphenyl

000092-52-4 Biphenyl

RT: 6.43; Ion: 154.10

User Specified

Add Skip ISTD Help

- 9 4-Chlorobiphenyl appears next. Keep the default name and click **Add**.

Choose Compound Name

4-Chlorobiphenyl

002051-62-9 4-Chlorobiphenyl

RT: 7.74; Ion: 188.15

User Specified

Add Skip ISTD Help

- 10 Methyl palmitate appears next.

To designate this as an internal standard, click **ISTD**. For this demonstration, we will identify this as an internal standard. Internal standard is a compound you plan to inject into each sample you test to serve as a normalizing factor, and a basis for comparison.

Choose Compound Name

Methyl palmitate

000112-39-0 Methyl palmitate

RT: 9.78; Ion: 74.10

User Specified

Add Skip ISTD Help

Clicking **ISTD** adds this compound to the quantitation database and positions it *at the top of the list of compounds in the quantitation database*, which is very important because internal standards must precede all compounds that will be quantitated relative to it in the quantitation database.

11 When the software prompts to **Quantitate now?** click **Yes**.

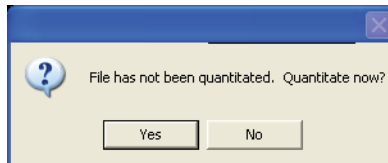

After the file is quantitated, the **Update Calibration** dialog box will appear.

12 Select **Add New Level** and enter the following:

Calib Level ID = 50

This is a descriptive label only.

Cmpd Conc = 50

The prepared concentration of the compound.

ISTD Conc = 50

The prepared concentration of the internal standard.

Then click **Do Update**.

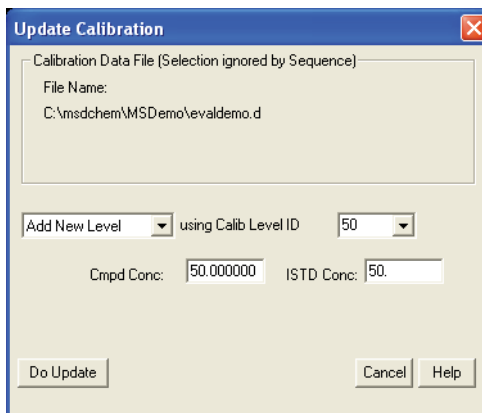

13 The **Edit Compounds** box appears next and it displays the complete list of compounds in your quantitative database. Note the following:

- Methyl palmitate (the compound you identified as the internal standard) has been moved to the top of the list (even though it eluted after two other compounds in the group) and it has a star by its name.
- The *star* (*) indicates that it is an internal standard.
- The internal standard *must precede* the compounds that refer to it, other than that, order is not important in the quantitation database.

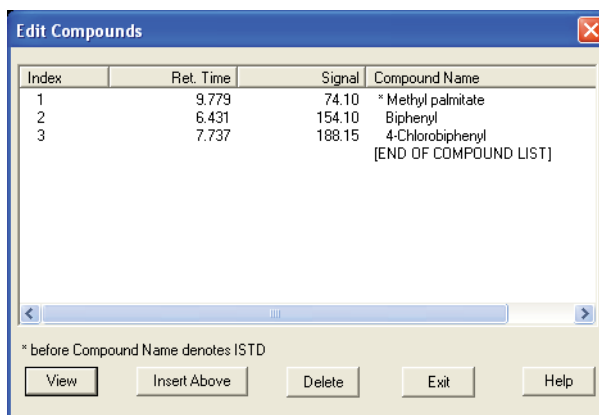

14 The entries for this single-level quantitation database are now complete.

Select any compound in the list and click **View** to examine that compound's parameters on Page 1, 2, and 3. Click **OK** or **Cancel** to return to the **Edit Compounds** box.

15 Click **Exit** to close the dialog box.

Understanding Quantitation

Compound #2 -- Page 1

Name: 4-Chlorobiphenyl Concentration Units: []

Retention Time Information
Ret Time: 7.737
Extract signals from: - 0.500 + 0.500 Min %
This is 7.237 to 8.237 min
Ref Spec Name: []

Quantitation Parameters
Quant type: Target compound
Measure response by: Area

Signals to Be Used for Quantitation
Quant signal: Target Ion

m/z	Relative Response	% Uncertainty
Tgt: 188.15	100.0	
Q1: 152.10	44.60	35.00
Q2: 190.15	32.80	35.00
Q3: 153.10	18.90	35.00

Buttons: Prev Next Plot Page 2

Compound #2: 4-Chlorobiphenyl (Page 2)

Special compound attributes
CAS #: [] Compound Type: T

Special reporting parameters
Surrogate amount: 0.000000 Matrix spike amount: 0.000000

	LOW	HIGH	% Dev	MDL
Matrix A (conc)	0.000000	0.000000	0.000000	0.000000
Matrix B (conc)	0.000000	0.000000	0.000000	0.000000

Signal level Minimum: 0.000000
MS Database Name: []

User defined items
A1 [] N4 0.00000
A2 [] N5 0.00000
A3 [] N6 0.00000

Buttons: Prev Next Page 1

Compound #2: Dodecane (Page 3)

LvlID	Conc	Response	LvlID	Conc	Response
50	50	975853.000			

Area Correction Mass: 0.00 Correction Factor: 0.0000

Sum? Integration Parameter File

Tgt	<input type="checkbox"/>	[]	Browse...
Q1	<input type="checkbox"/>	[]	Browse...
Q2	<input type="checkbox"/>	[]	Browse...
Q3	<input type="checkbox"/>	[]	Browse...

Buttons: Prev Next Plot Page 1 Page 2 OK Cancel Help

16 Now we will go back and add the compound we skipped in [step 7](#).

To begin to insert this compound into the quantitation database, select **Calibrate/AutoQuant Setup** or click icon.

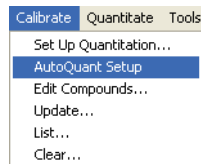

17 Select **Insert Compounds in Database** and click **OK**.

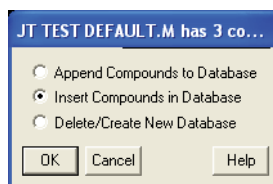

18 When the **Quantitation Database Globals** dialog box appears, do not change the parameters.

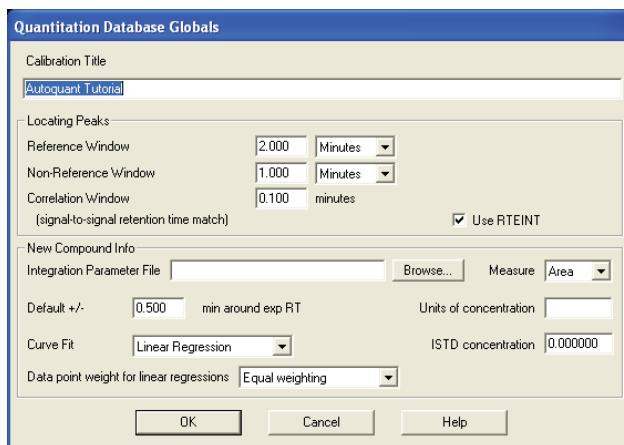

Click **OK**. The software will again start the process of identifying the same peaks again.

The **Choose Compound Name** dialog box will appear.

- 19 When Dodecane appears in the dialog box, keep the default name and click **Add**.

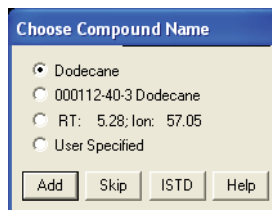

The **Edit Compounds** box will appear.

- 20 Select an insertion point by highlighting Biphenyl and clicking **Insert Above**.

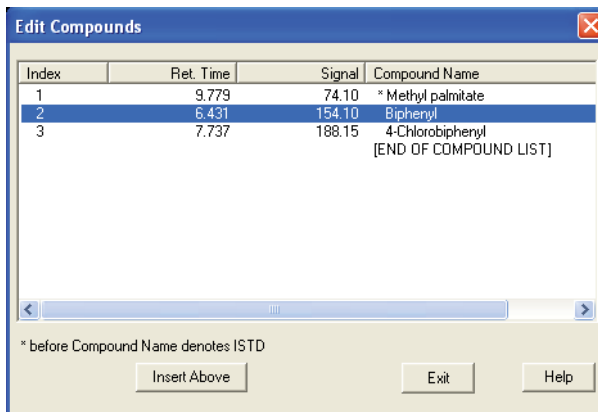

- 21 The **Choose Compounds** box appears for the remaining compounds. For each of the three remaining compounds in this data file, click **Skip** when asked to choose a compound name and click **Yes** to **Continue Peak Entry**.

22 When asked if you want to quantitate the database, click **Yes**.

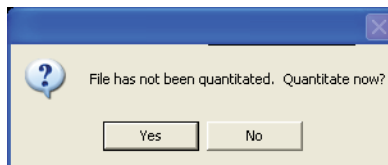

23 When the **Update Calibration** dialog box appears, select: **Recalibrate** (from the drop-down list), **Replace** (from the drop-down list) for the Responses and Retention Times fields.

Recalibrate updates all instrument response values and retention times for the specified level ID with the values found in the loaded data file. All other entries that you specified for the compound are returned.

Click **Do Update**.

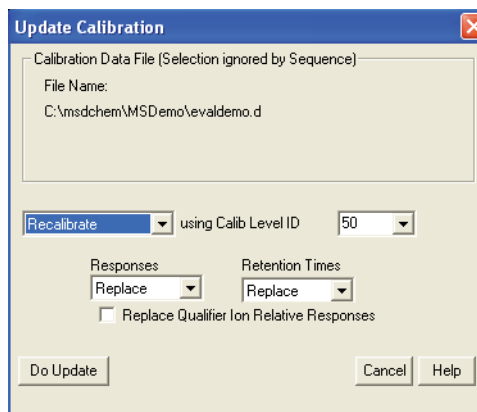

24 When the **Edit Compounds** box appears, click **View** and examine Page 3 for each of the four compounds in the quantitation database.

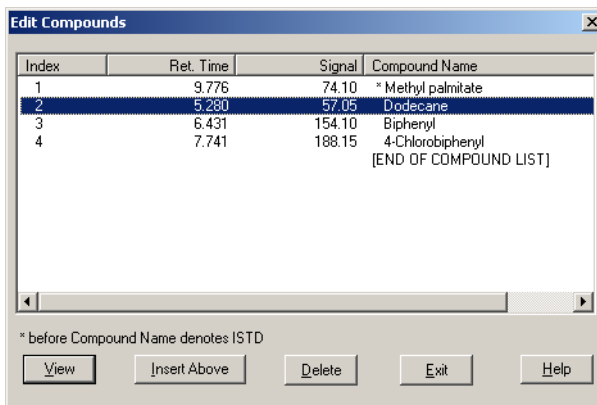

Note that Dodecane, which you just added, does not have a concentration value.

Click **Prev** or **Next** to examine page 3 of the other compounds. The others have a value of 50 for the concentration.

This was entered globally when this level was first created (in [step 12](#)).

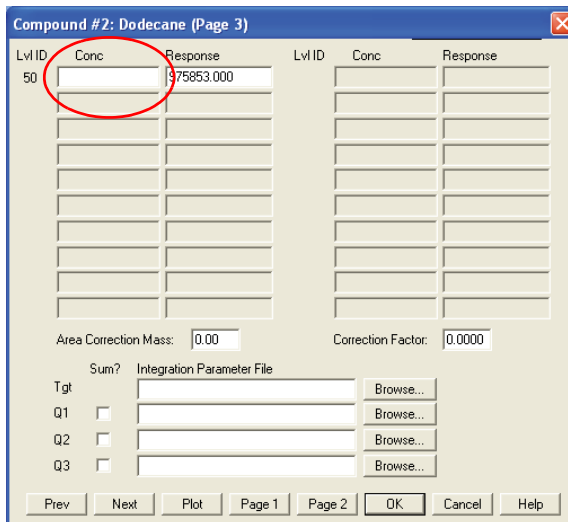

25 Type **50** in the Concentration field for level 50. Click **OK** and then **Yes** to save the change.

Compound #2: Dodecane (Page 3)

Lvl ID	Conc	Response	Lvl ID	Conc	Response
50	50	975853.000			

Area Correction Mass: 0.00 Correction Factor: 0.0000

Sum? Integration Parameter File

Tgt Browse...

Q1 Browse...

Q2 Browse...

Q3 Browse...

Prev Next Plot Page 1 Page 2 OK Cancel Help

Compound #2: Dodecane (Page 3)

 Save changes to compound?

Yes No Cancel

26 You are now back on the **Edit Compounds** screen. Your quantitation database now has been updated and it is ready to be used.

Click **Exit** to complete the process.

You have now created a method containing a quantitation database that can identify and quantify Biphenyl, Dodecane, Chlorobiphenyl, and Methyl palmitate.

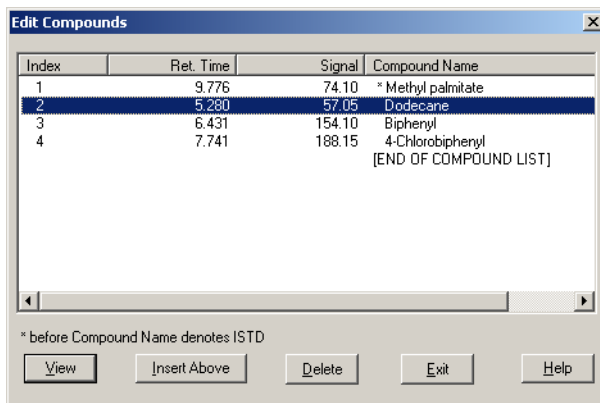

Now that you have completed this tutorial you can easily set up your own quantitation database using the compounds of interest to you.

NOTE

For in-depth instructions on how to operate your GC/MSD ChemStation, check the online help.

For complete details on operating, maintaining, and troubleshooting your hardware, check the CD-ROM supplied with your instrument.



3 Using Custom Reports

Custom Reports	92
Creating a Report Template	93
Customizing Reports	97
Selecting Cells, Rows, and Columns	102
Printing Reports	104
Creating a Custom Reports Database	107
Selecting Multiple Data Files	110
Viewing and Printing Charts	112
Custom Reports Menus	113
Custom Reports Toolbar Buttons	114



Custom Reports

Overview

Custom Reports lets you transfer quantitative results from Data Analysis into the custom reports spreadsheet program where you can create your own customized reports.

You can also set up custom reports databases from multiple samples, then view and print charts of the data.

Once a report template or database has been created and linked to a method, you can print the report or update the custom reports database automatically whenever the method is run.

You can only use custom reports on quantified data.

Getting started

This chapter guides you through the basic steps of creating a custom report template or database. These steps are a starting point for becoming familiar with the Custom Reports software.

Once you are comfortable, explore the software on your own. Experiment with the editing or formatting features. Use the online help for more information about the features and how they work.

Starting the Custom Reports software

In the Data Analysis view, select **Quantitate/Custom Reports** or click the custom reports icon.



You are asked if you want to use default values, if the current method has no quantitation database or if a data file has not been loaded.

Click **OK**. The **Custom Reports Paper Size** box appears next, select the paper size you want and click **OK**.

Creating a Report Template

A few seconds after starting the Custom Reports software, the Control Panel (shown below) is displayed.

- 1 Select **Create New Report Template** and click **OK**.

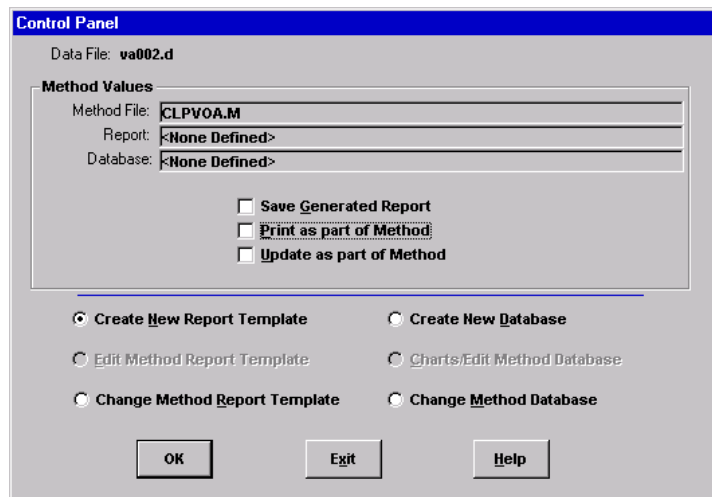

Create New Report Template

Allows you to build a custom report template by using the Report Wizard.

Edit Method Report Template

Allows you to modify the custom report template.

Change Method Report Template

Allows you to select the report template to use with the method.W

Create New Database

Allows you to build a custom reports database by using the Database Wizard.

Chart/Edit Method Database

Allows you to view charts and modify the custom report database.

Change Method Database

Allows you to select the database to use with the method.

- 2 The Report Wizard is displayed, select an item from the **Report Contents** list on the right. In the left panel, **Possible Items for Report** lists all items you can select for the report template. In the right panel, **Report Contents** lists the items you have selected.
- 3 Select an item from the **Possible Items for Report** list on the left.
- 4 Double-click the selected item or click **Add**. The selected item gets added after the highlighted item on the right.
- 5 Repeat steps 1-4 until all items for your report template are added. You can use **Remove** to delete the items from the **Report Contents** list on the right.
- 6 Scroll down the **Possible Items for Report** list on the left, there are Graphics items you may add to your report template. The Globals items under Graphics get added into the **Reports Content Header** section while the Compound items get added to the **All Compound** sections.
- 7 Click **OK** when you have finished selecting report items using the Report Wizard.

A report template is created based on the selections you made.

- 8 The Custom Reports Sheet1 (shown below) is displayed, at this point you may select **File/Save** or click the **Save** icon to save the report template.
- 9 The **Link with Method** box is displayed next. This dialog box lets you select this template as the default for the method and to automatically print whenever the method is run.
- 10 Select **File/Exit** to exit the Custom Reports program.

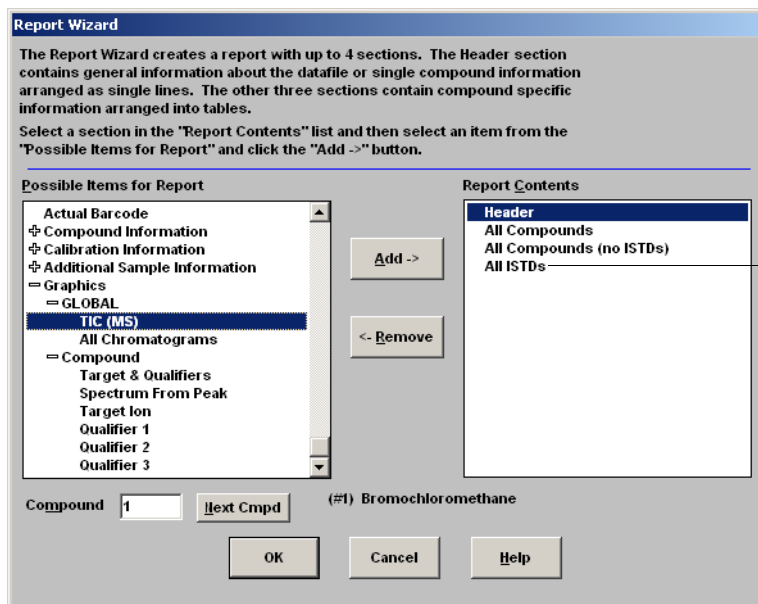

Example

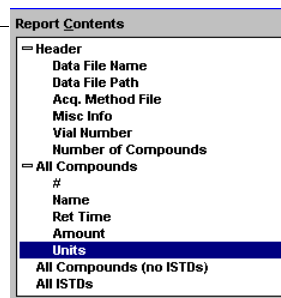

+ Click the plus sign to open sub-item listing

- Click the minus sign to close sub-item listing

Using Custom Reports

Report Contents

- Header
 - Data File Name
 - Data File Path
 - Acq. Method File
 - Misc Info
 - Vial Number
 - Number of Compounds
- All Compounds
 - #
 - Name
 - Ret Time
 - Amount
 - Units
 - All Compounds (no ISTDs)
 - All ISTDs

Custom Reports - C:\DOCUMENTS AND SETTINGS\JMT\MY DOCUMENTS\REPORT.CRT

File Edit Format View Tools Help

Time-->

#	Name	Ret Time	Amount	Units
52	6420			
53	6415			
54	6410			
55	6405			
56	6400			
57	6395			
58	6390			
59	6385			
60				
61				
62				
63				
64				
65				
66				
67				
68				
69				
70				
71				
72	1) Bromochloromethane	7.95	50.00	ug/l
73	2) Chloromethane	0.94	56.44	ug/l
74	3) Bromomethane	1.59	50.33	ug/l
75	4) Vinyl Chloride	2.06	52.84	ug/l
76	5) Chloroethane	2.80	55.83	ug/l
77	6) Methylene Chloride	4.66	52.32	ug/l
78	7) Acetone	5.28	58.84	ug/l
79	8) Carbon Disulfide	6.05	49.70	ug/l
80	9) 1,1-Dichloroethene	7.41	52.35	ug/l
81	10) 1,1-Dichloroethane	8.73	50.53	ug/l
82	11) 1,2-Dichloroethene (total)	9.54	52.79	ug/l
83	12) Chloroform	10.16	51.17	ug/l

Sheet 7

Customizing Reports

Editing a report

- 1 Select **Quantitate/Custom Reports** or click the **Custom Report** icon. The Control Panel is displayed. Select **Edit Method Report Template** <report.CRT> on the Control Panel. Report under Method Values displays (<report.CRT> which is the name of the report template you want to modify).



If the name of the report you want is not displayed, select **Change Method Report Template** on the Control Panel and select the report you want. When the Control Panel is redisplayed, select **Edit Method Report Template**.

Click **OK** to display the report template <report.CRT> .

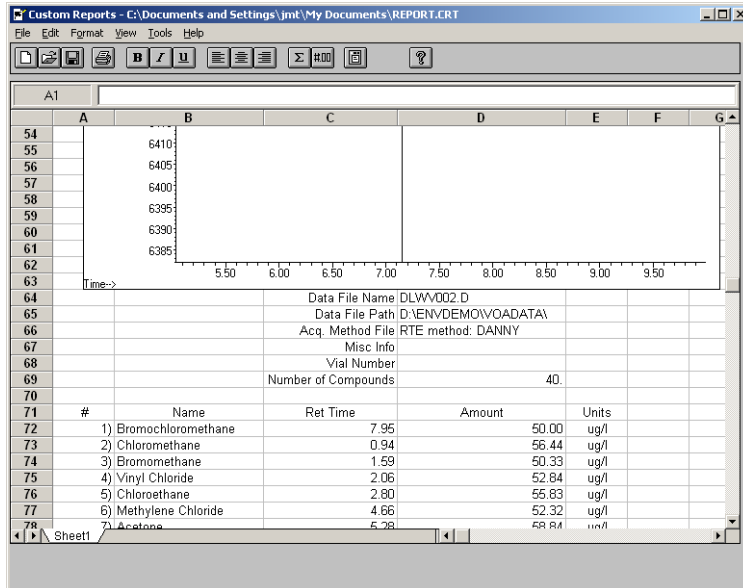

- 2 You can make changes to any cell in the spreadsheet. You can use the **Edit Box** (shown below) to make changes. You may want to save the report periodically to avoid losing any of your changes.
- 3 To access this dialog box, select **View/Edit Box** or click the **Edit Box** icon on the toolbar.
- 4 When you are done modifying, save the report template.

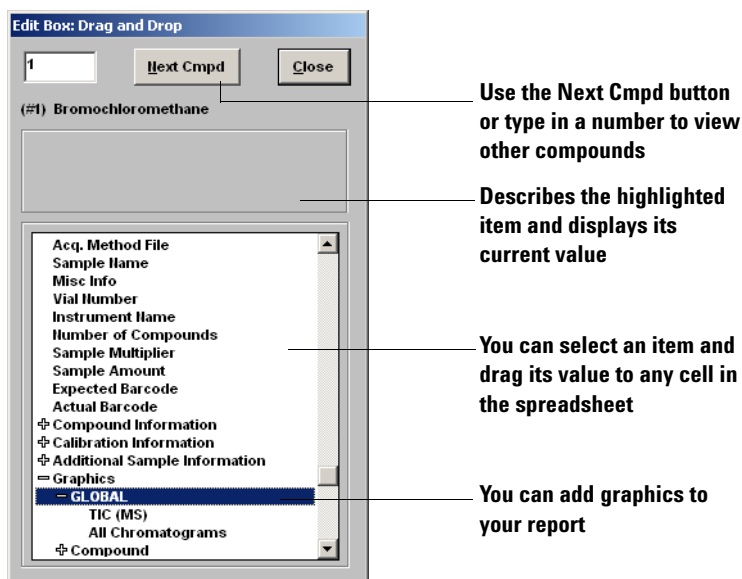

Formatting a report

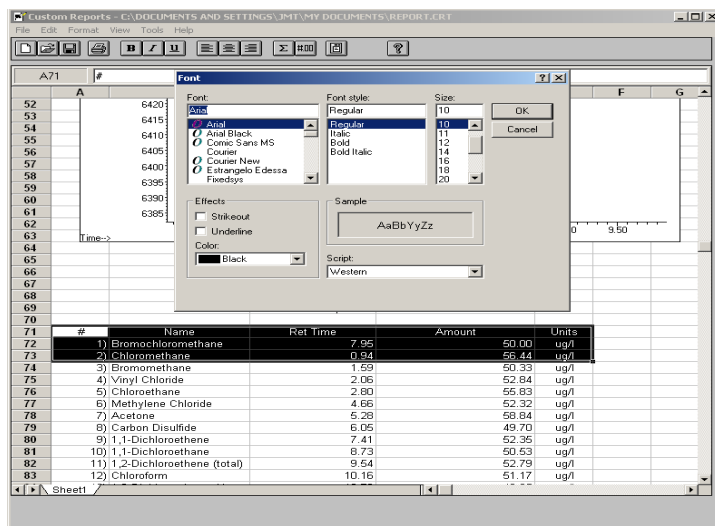

When you create a report template, the software formats the report automatically. You can customize the report format using the Format menu, by performing a mouse action, or using the toolbar. Any formatting changes are saved when the report template is saved.

- 1 Highlight the cell(s) you want to format.
- 2 Choose a format in one of the following ways:
 - Select an item from the Format menu. Make selections on the dialog box and click **OK**.
 - Click a format button on the toolbar (for example, Bold or Left Align).
 - Adjust the column width or row height (see below).
- 3 Continue until the report is formatted the way you want.
- 4 Save the report periodically to avoid losing any formatting changes, and save the report template when you are finished.

Adjusting the row height or column width

Adjusting row height

- 1 Put cursor near bottom of row number box where cursor changes.
- 2 Click and drag up and down to adjust the row to the height you want.

Adjusting column width

- 1 Put cursor near column letter where cursor changes.
- 2 Click and drag up and down to adjust the column to the width you want.

Making multiple rows same height

- 1 Click and drag on row numbers to select rows.
- 2 Adjust the row height of one row and all others are set to the same height.

Making multiple columns same width

- 1 Click and drag on column letters to select columns.
- 2 Adjust the column width of one column and all others are set to the same width.

Saving a report

- 1 Select **File/Save** or click **Save** on the toolbar.
- 2 Enter a file name (do *not* type the .CRT extension) and click **Save**. The **Link With Method** dialog box is displayed. This dialog box lets you select this template as the default for the method and to automatically print whenever the method is run.
- 3 Select or deselect the appropriate checkboxes and click **OK**.
- 4 Select **File/Exit** or click **Close** on the title bar to exit Custom Reports.

Format Menu

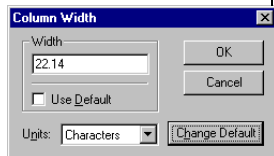
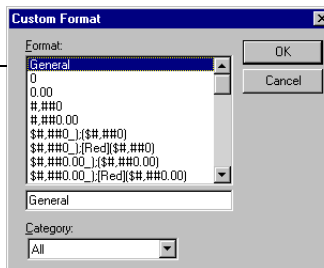
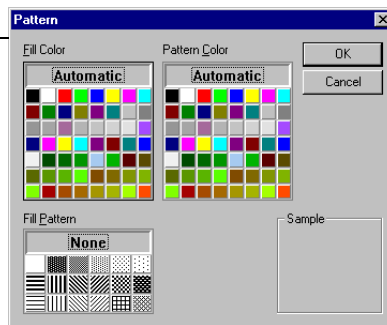
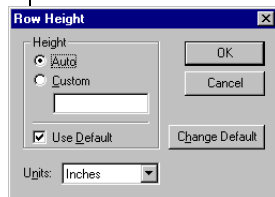
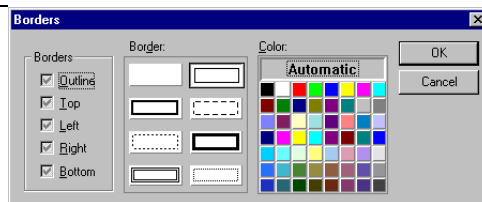
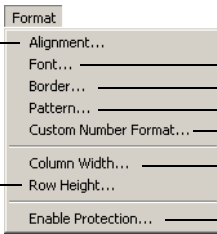
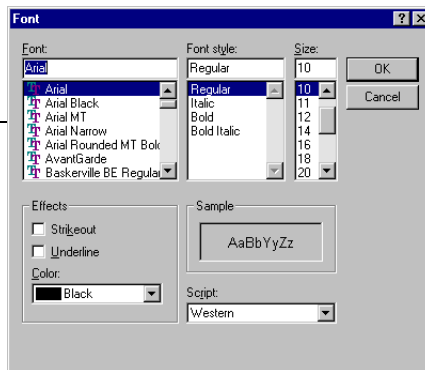
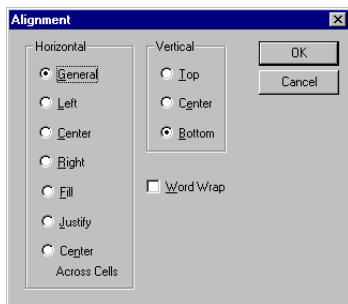

Selecting Cells, Rows, and Columns

Selecting a group of cells

Click and drag within spreadsheet to select the group of cells you want.

Selecting a row or column

Click the row number or column letter.

Selecting multiple rows or columns

Click and drag on row numbers or column letters.

Selecting multiple, noncontinuous, single cells

Hold down [Ctrl] and click the cells.

Selecting multiple, noncontinuous, rows or columns

Hold down [Ctrl] and click the row numbers or column letters.

Selecting multiple continuous items

Click the first item (cell, column, or row) you want to select and press and hold [Shift] while you click on the last item in the group. All items in between first and last item are selected.

Column letters

Click here to select entire spreadsheet

Row numbers

Spreadsheet cell

#	Name	Ret Time	Amount	Units
1)	Bromochloromethane	9.61	50.00	ug/l
2)	Chloromethane	2.10	205.97	ug/l
3)	Vinyl Chloride	2.24	265.07	ug/l
4)	Bromomethane	2.73	205.91	ug/l
5)	Chloroethane	2.98	220.21	ug/l
6)	1,1-Dichloroethene	4.59	126.84	ug/l
7)	Carbon Disulfide	4.92	224.62	ug/l
8)	Acetone	5.27	205.95	ug/l
9)	Methylene Chloride	6.13	156.93	ug/l
10)	1,2-Dichloroethene (total)	6.74	193.30	ug/l
11)	1,1-Dichloroethane	7.79	188.32	ug/l
12)	Chloroform	9.95	189.67	ug/l
13)	1,4-Dichloroethane-d4	10.98	79.70	ug/l
14)	1,2-Dichloroethane	10.98	186.11	ug/l
15)	1,4-Difluorobenzene	11.79	50.00	ug/l
16)	2-Butanone	9.42	196.63	ug/l
17)	1,1,1-Trichloroethane	10.04	181.59	ug/l
18)	Carbon Tetrachloride	10.34	193.75	ug/l
19)	Benzene	10.81	183.19	ug/l
20)	Trichloroethene	12.16	180.64	ug/l
21)	1,2-Dichloropropane	12.59	165.56	ug/l
22)	Vinyl Acetate	13.06	215.22	ug/l
23)	Bromodichloromethane	13.24	184.89	ug/l
24)	cis-1,3-Dichloropropene	14.18	190.43	ug/l

Printing Reports

Create (or load) a report template

Previewing a report before printing

- 1 Select **File/Print Preview**. The report is displayed in a preview panel that lets you see how it will look when it is printed.
- 2 Use **Next Page** and **Prev Page** to move from one page to another.
- 3 Click **Print**. The preview panel is closed and the report is printed.

Printing a report

- 1 Select **File/Print** or click **Print** on the toolbar. The **Print** dialog box is displayed.
- 2 Select print options (print range, number of copies, and print quality), then click **OK**.

Use the **File/Page Setup** dialog box to set up how pages are printed (click **Help** to see details).

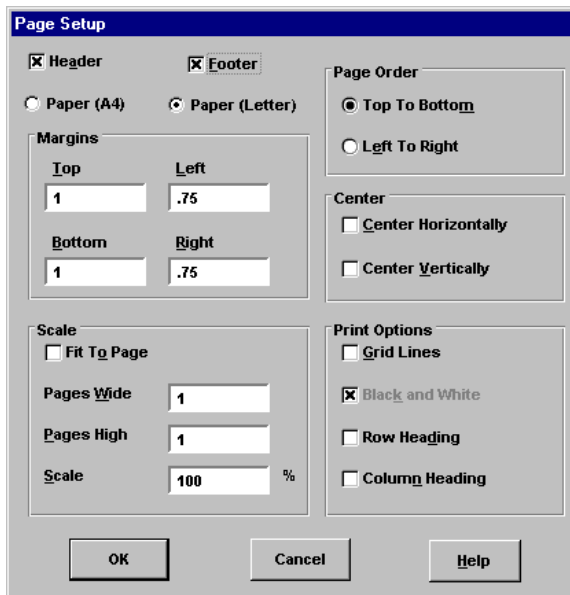

Printing reports automatically

There are two ways to set up reports to be printed automatically when a method is run:

- Create (or load) the report template, then select **Print as part of Method** in the Method Values section of the Control Panel.
- When you save a report template, the **Link With Method** dialog box is displayed. Select **Print Report as part of the Run Method** and click **OK**.

Printing multiple reports automatically

- 1 Create (or load) a report template.
- 2 Select **File/Multiple File Select**. The **Multiple File Select** dialog box is displayed.

- 3 Select the directory where your data files are located (if it is not already selected).
- 4 Select the data files you want to print.
 - Select a data file name.
 - Double-click the selected file (or click right arrow).
 - Repeat until all data files are listed in the **Files Selected for Processing** section.

NOTE

You can select files individually or use standard Windows file selection techniques to select files as a group.

- 5 Click **OK**. The data files are printed in the order listed using the current report template.

Creating a Custom Reports Database

Before you begin

- In the Data Analysis view, select **Quantitate/Custom Reports**.
- If the current method has no quantitation database or if a data file has not been loaded, you are asked if you want to use default values. Click **Yes** and the **Control Panel** is displayed (shown below)

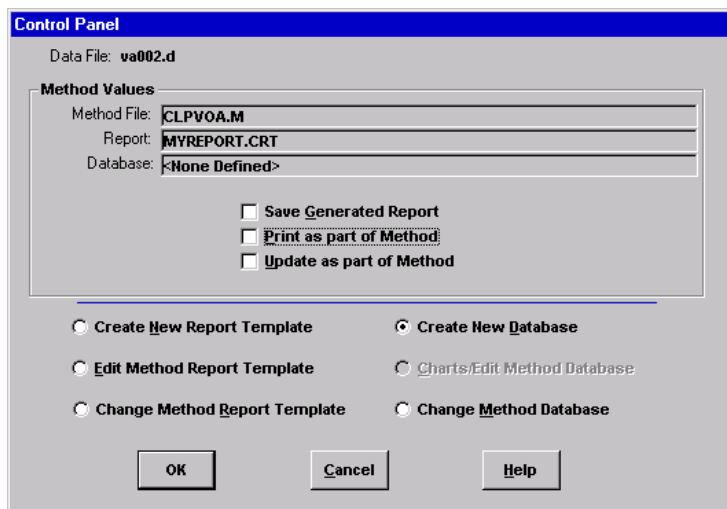

Procedure for creating a database

- 1 Select **Create New Database** on the Control Panel and click **OK**.
- 2 The **Database Wizard** is displayed. On the left, **Possible Item for Database** lists all items you can select for the custom reports

database content. On the right, **Database Contents** lists all selected items to be included in the custom reports database.

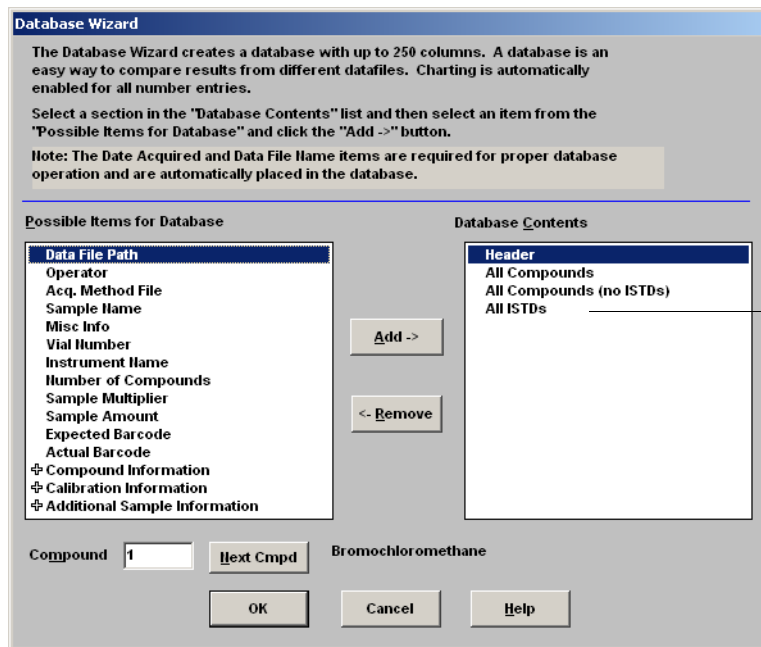

Example

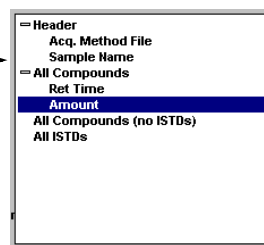

+ Click the plus sign to open subitem listing

- Click the minus sign to close subitem listing

- a Select a **Database Contents** section from the list on the right.
- b Select an item from the **Possible Items for Database** list on the left.
- c Double-click the selected item or click **Add**. The selected item gets added after the highlighted item on the right.
- d When you have finished selecting items, click **OK**.

When you click **OK** on the Database Wizard, the following prompt is displayed:

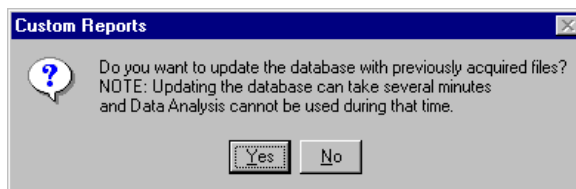

If you do not want to update the database, click **No**. The **Control Panel** is displayed.

3 Otherwise, to update the database.

- Click **Yes**, the **Multiple File Select** dialog box is displayed. Select the data files you want to add to the database, and click **OK**.

4 Enter a file name and click **Save** when the **Save As** dialog box is displayed.

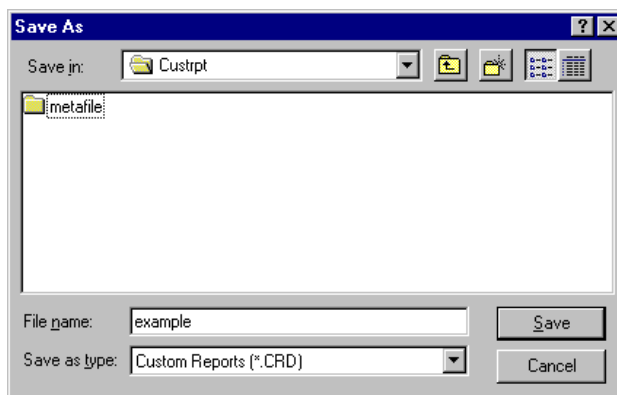

5 When the **Link With Method** dialog box is displayed, select or deselect the appropriate checkboxes and click **OK**. The database is now updated.

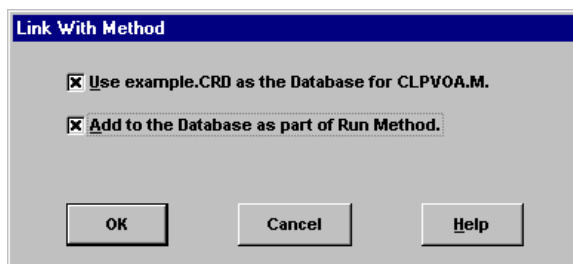

Selecting Multiple Data Files

Use this dialog box when you want to print multiple reports or load multiple previously acquired data files into a database.

This dialog box is accessed by selecting **File/Multiple File Select**.

- 1 Select the directory where the data files are located.
- 2 Select the data files in the **Data File Name** box you want to use and click the right arrow key (or double-click a file name).
- 3 Click **OK** to process the selected data files.

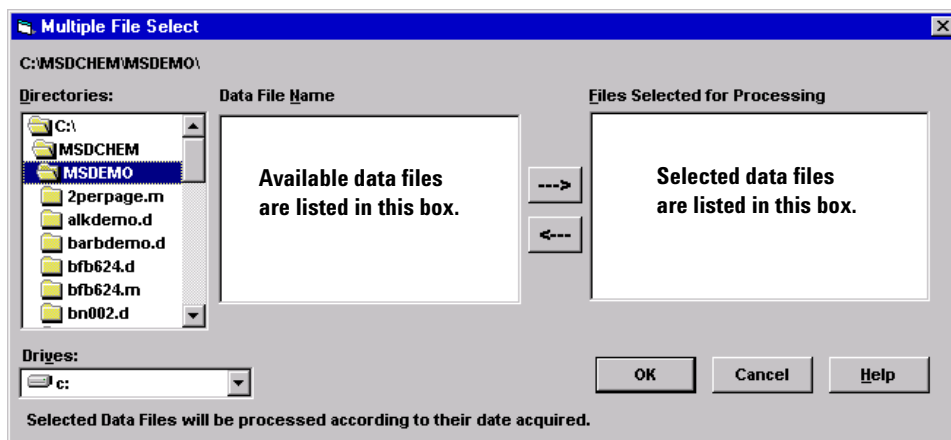

Select two or more files in sequence

Click the first file you want to select and drag the mouse to the last file in the group.

Or

Click the first file you want to select. Press and hold down [Shift] while you click the last file in the group.

Select two or more items out of sequence

Press and hold down [Ctrl] while you click each file.

Cancel a selection

Press and hold down [Ctrl] while you click the highlighted file.

For reports

The selected data files are printed using the current report template. Reports are printed in the order of the listed files.

For databases

The selected data files are loaded into the current database. Files are automatically sorted in chronological order by date acquired when they are added to the database.

Viewing and Printing Charts

The dialog box below is displayed when you select **Charts/Edit Method Database** on the Control Panel, click **Charts** on the custom reports toolbar or select **Charts/View Charts**. Use this dialog box to view and print charts of the data in a database.

NOTE

Click the chart to display the **Individual Chart Options** dialog box.

Selects the item to chart on X-Axis. Defaults are Data File Name and Date Acquired.

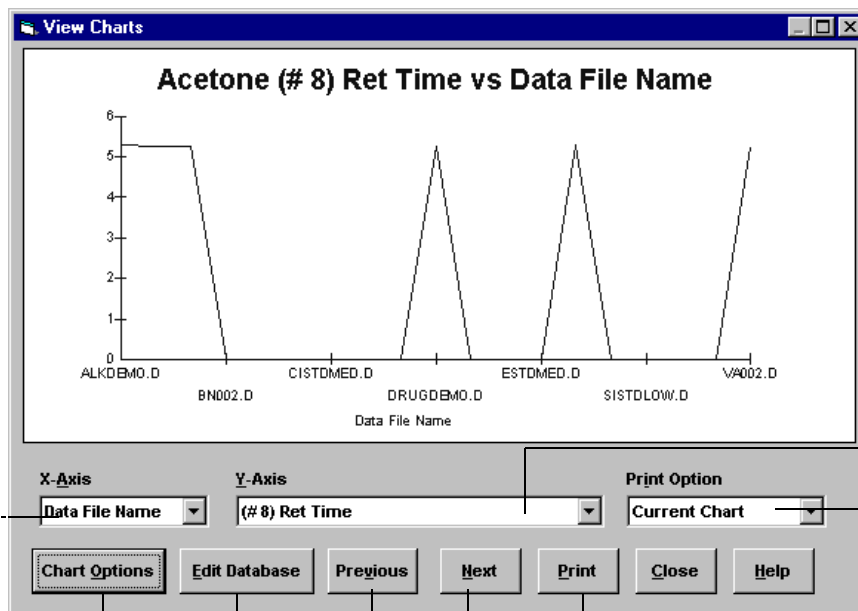

Selects the item to chart on Y-Axis (only number items can be used).

Lets you choose to print the current chart or all charts in the database.

Displays the Chart Options dialog box.

Goes to the previous or next chart listed in the Y-Axis selection box.

Closes the View Charts dialog box and displays the Control Panel.

Exits the View Charts dialog box and lets you edit the current database.

Prints the current chart or all charts as specified by Print Option.

Custom Reports Menus

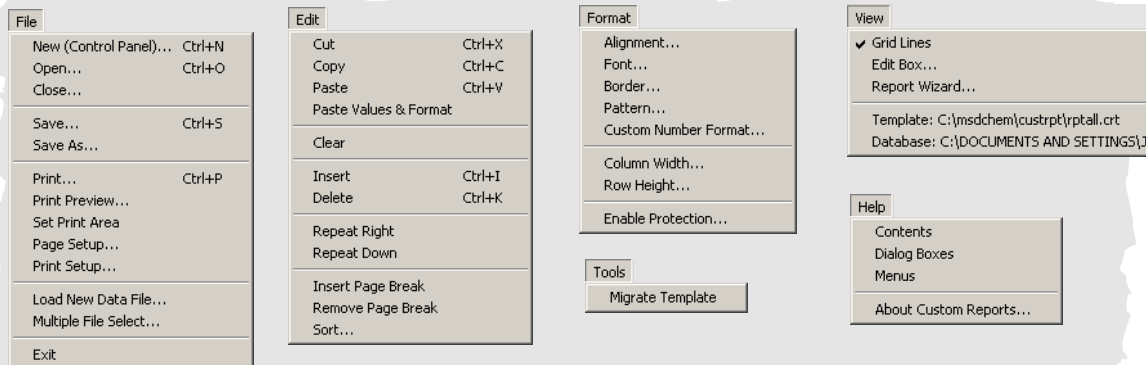

Custom Reports Toolbar Buttons



Displays the Control Panel.



Opens a custom reports template (.crt) or database (.crd) file.



Saves a report or database then displays the Link With Method dialog box.



Prints a report or database.



Applies (or removes) bold format to the selected text.



Applies (or removes) italic format to the selected text.



Applies (or removes) an underline to the selected text.



Aligns the contents of selected cells to the left cell margin.



Centers the contents of selected cells between the left and right cell margins.



Aligns the contents of selected cells to the right cell margin.



Inserts a formula into the selected cell that is a summation of the cells above it.



Displays the Custom Format dialog box.



Displays the Edit Box: Drag & Drop dialog box.



Displays the View Charts dialog box. This button is only available for databases.



Displays the Contents page of the online help.



Agilent Technologies

© Agilent Technologies, Inc.

Printed in USA, June 2005



G1701-90056