

Agilent Gas Chromatographs

Fundamentals of Gas Chromatography



Agilent Technologies

Notices

© Agilent Technologies, Inc. 2002

No part of this manual may be reproduced in any form or by any means (including electronic storage and retrieval or translation into a foreign language) without prior agreement and written consent from Agilent Technologies, Inc. as governed by United States and international copyright laws.

Manual Part Number

G1176-90000

Edition

First edition, May 2002

Printed in USA

Agilent Technologies, Inc.
2850 Centerville Road
Wilmington, Delaware 19808-1610 USA

In This Book...

This book contains information for using your gas chromatograph (GC) effectively.

1 What Gas Chromatography Is

This chapter describes gas chromatography—its effects and its uses—and the chromatographic hardware.

2 Injecting Samples

This chapter describes the most common ways of getting the sample into the GC.

3 Separating Components

The column separates the sample into components. This chapter tells how this works and how to use it.

4 Detecting Components

This chapter describes three common GC detectors.

5 Interpreting Chromatograms

The final chapter discusses how to identify peaks and how to determine the amounts of each component.

Contents

1 What Gas Chromatography Is

A Separation in Time	10
The System	11
The gas source	12
The inlet	12
The column	14
The detector	14
Data reduction	15
Instrument control	15

2 Injecting Samples

Injection Ports	18
Packed port	18
Split/Splitless port	19
Injection technique	22
Benefits of automatic injection	23
Valves	24
Gas sampling	24
Liquid sampling	24
Inlet Temperature	25
Gas samples	25
Liquid samples	25

3 Separating Components

How a Column Separates Components	28
The basic principles of chromatography	29

Column Types	30
Capillary columns	30
Packed columns	30
Column tubing	31
Column Characteristics	32
Column efficiency	32
Gas control	33
Column resolution	33
Column selectivity	34
Capillary or Packed?	35
Column Temperature	36
Isothermal oven	36
Programmed oven	37

4 Detecting Components

Thermal Conductivity (TCD)	40
How it works	40
Flame Ionization (FID)	42
How it works	42
Electron Capture (ECD)	43
How it works	43

5 Interpreting Chromatograms

Peak Measurements	47
Retention time	47
Peak size	47
Integrators and data systems	48
Component Identity	49
Component Amount	50
Uncalibrated calculations	50

Area and height percent	50
Calibrated calculations	52
Normalization	54
External standard	55
Internal standard	56

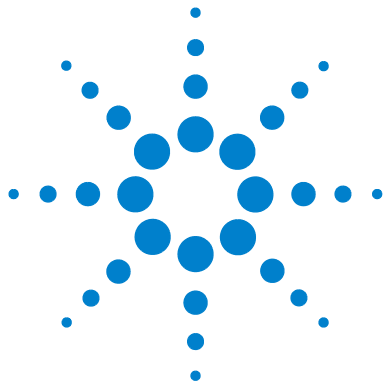

1 What Gas Chromatography Is

- A Separation in Time 10
- The System 11
 - The gas source 12
 - The inlet 12
 - The column 14
 - The detector 14
 - Data reduction 15
 - Instrument control 15

Gas chromatography (GC) is a laboratory technique that separates mixtures into individual components. It is used to identify components and to measure their concentrations.



A Separation in Time

Rather than a physical separation (such as distillation and similar techniques), GC creates a time separation.

It does this by passing the vaporized mixture (or a gas) through a tube containing a material that retards some components more than others. This separates the components in time. After detection, the result is a chromatogram (Figure 1), where each peak represents a different component of the original mixture.

The appearance time can be used to identify each component; the peak size (height or area) is a measure of the amount.

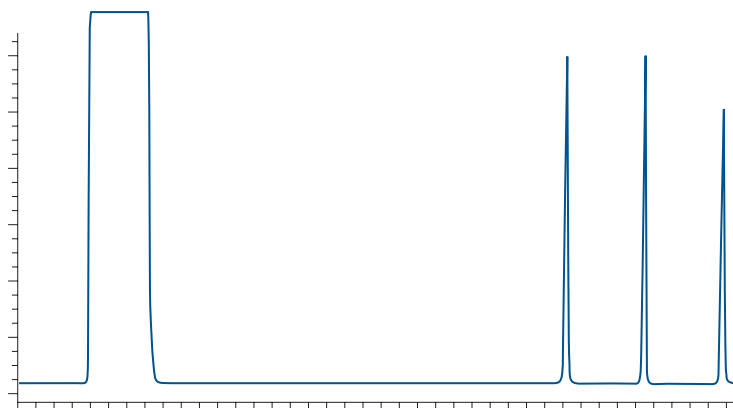

Figure 1 A typical chromatogram

The System

A gas chromatographic system consists of:

- A regulated and purified carrier gas source, which moves the sample through the GC
- An inlet, which also acts as a vaporizer for liquid samples
- A column, in which the time separation occurs
- A detector, which responds to the components as they occur by changing its electrical output
- Data interpretation of some sort

This is summarized in [Figure 2](#).

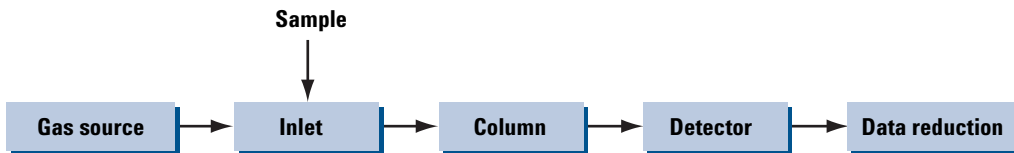

Figure 2 A chromatographic system

The gas source

The carrier gas must be pure. Contaminants may react with the sample or the column, create spurious peaks, load the detector and raise baselines, and so on. A high-purity gas with traps for water, hydrocarbons and oxygen is recommended. See [Figure 3](#).

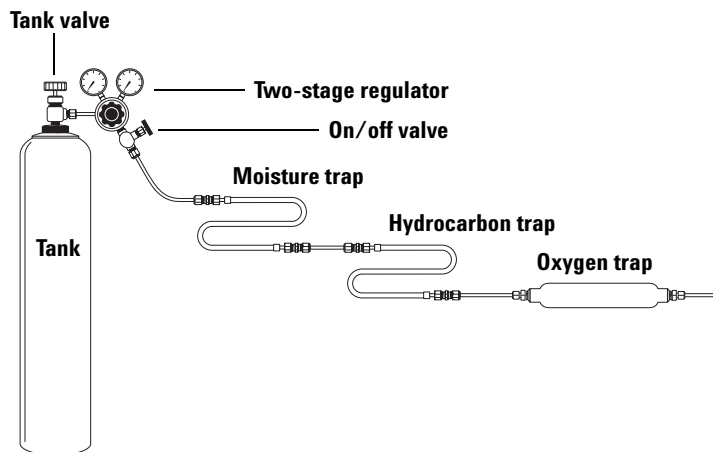

Figure 3 The gas source

When a house gas supply, rather than separate tanks, is used, have traps for each GC and place them as close to the back of the instrument as possible.

The inlet

The inlet introduces the vaporized sample into the carrier gas stream. The most common inlets are injection ports and sampling valves.

Injection ports

Handle gas or liquid samples. Often heated to vaporize liquid samples. Liquid or gas syringes are used to insert the sample through a septum into the carrier gas stream. The principle (not a real design) is shown in Figure 4.

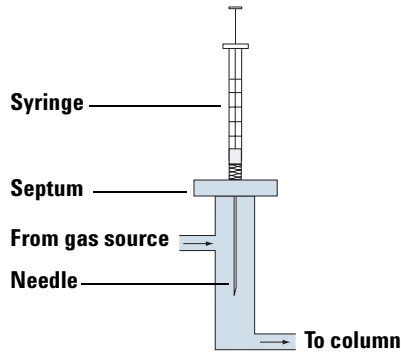

Figure 4 Injection port

Sampling valves

The sample is flushed from a loop which is mechanically inserted into the carrier gas stream. Different valves are used for liquids and gases, because sample volumes are usually quite different. The principle (not a real design) is shown in Figure 5.

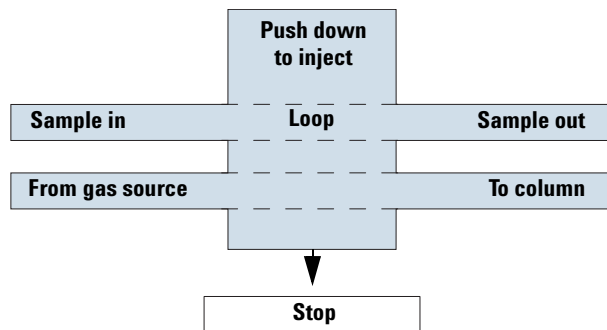

Figure 5 Sampling valve

Sample valves are often connected to an inlet, especially the split/splitless inlet in the split mode.

The column

The separation happens here. Because the column type is selected by the user, many different analyses can be performed using the same equipment.

Most separations are highly temperature-dependent, so the column is placed in a well-controlled oven. See [Figure 6](#).

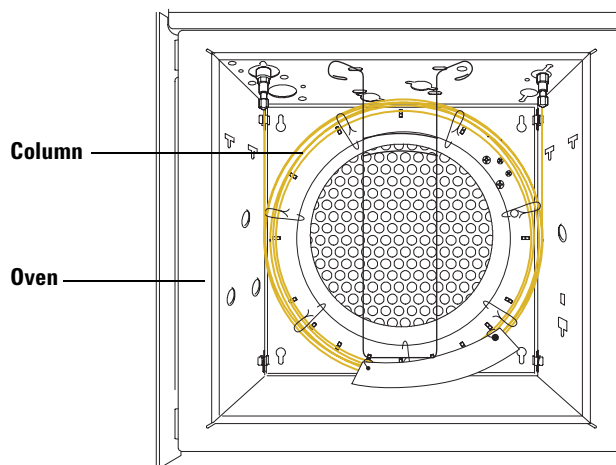

Figure 6 The column and oven

The detector

The gas stream from the column, which contains the separated components, passes through a detector. The output from the detector becomes the chromatogram. See [Figure 7](#).

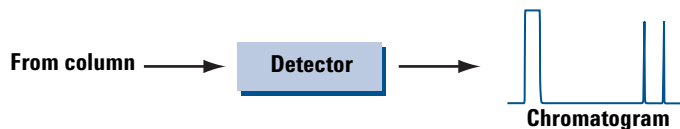

Figure 7 The detector

Several detector types are available, but all perform the same tasks:

- Produce a stable electrical signal (the baseline) when pure carrier gas (no components) is in the detector.
- Produce a different signal when a component is passing through the detector.

Data reduction

Measurement

The chromatogram leaves the detector as an electrical signal. It can be:

- Recorded on a strip chart recorder
- Processed by a digital integrator
- Processed by a computer-based data system

A strip chart recording must be measured to determine the peak times and sizes. Integrators and data systems perform these measurements directly. They are strongly recommended because of their reproducibility and sensitivity.

Calculation

The list of times and sizes must be converted to component names and amounts. This is done by comparison to times and responses of known samples (calibration samples). This can be done manually, but for speed and accuracy, a data system is best.

Instrument control

Some data system/GC combinations also provide direct control of the GC by the data system computer. This allows the creation of stored methods, which are invoked as needed, and permits a high degree of analysis automation.

1 What Gas Chromatography Is

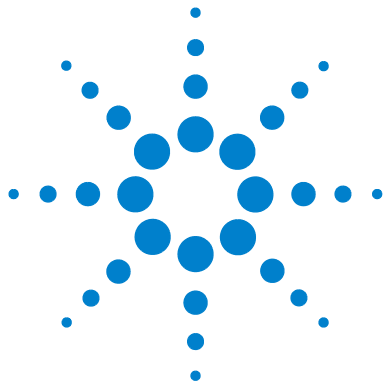

2 Injecting Samples

Injection Ports	18
Packed port	18
Split/Splitless port	19
Injection technique	22
Benefits of automatic injection	23
Valves	24
Gas sampling	24
Liquid sampling	24
Inlet Temperature	25
Gas samples	25
Liquid samples	25

Some samples are already gases (such as room or outside air, heating gas, etc.) and can be injected directly using either a gas syringe or a gas sampling valve.

Most samples are liquids and must be vaporized in order to be analyzed by gas chromatography. This is usually done with a heated injection port in combination with either a liquid syringe or liquid sampling valve.



Injection Ports

The design and choice of injection ports depends on the column diameter and type. The column types, packed and capillary, are described in the next chapter.

Packed columns and wide-bore capillary columns use the packed port; narrow-bore capillary columns use the split/splitless port.

Packed port

The packed port was developed for packed columns. Removable liners adapt it for the specific column diameter, usually either 1/8- or 1/4-inch. A typical design is shown in [Figure 8](#).

When wide-bore capillary columns appeared, liners were created to allow their use with the packed port. These columns have sample capacities similar to packed columns.

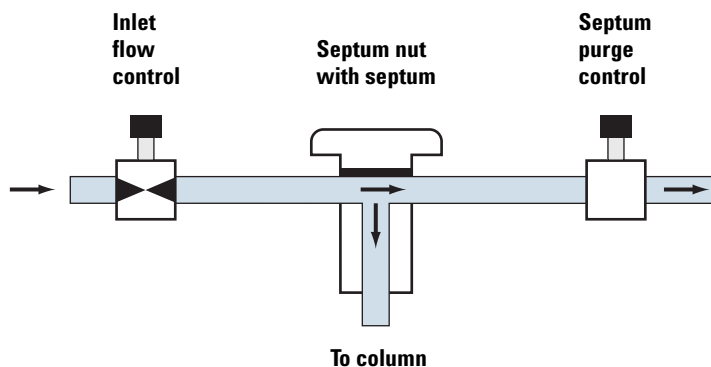

Figure 8 Packed injection port

The sample is injected with a syringe inserted through the septum into the carrier gas stream. The heated port vaporizes it (if it is a liquid) and the carrier gas sweeps it into the column.

Split/Splitless port

The split/splitless port, used with capillary columns, has two operating modes.

Split mode

Capillary columns have low sample capacities. Very small sample sizes, usually much less than a microliter, must be used to avoid overloading the column.

It is very difficult to handle such small sample sizes. The split mode provides a way to inject a normal-size sample, vaporize it, and then transfer only part of it to the column for analysis. The rest is vented to waste.

A typical split/splitless port in *split mode* is shown in Figure 9.

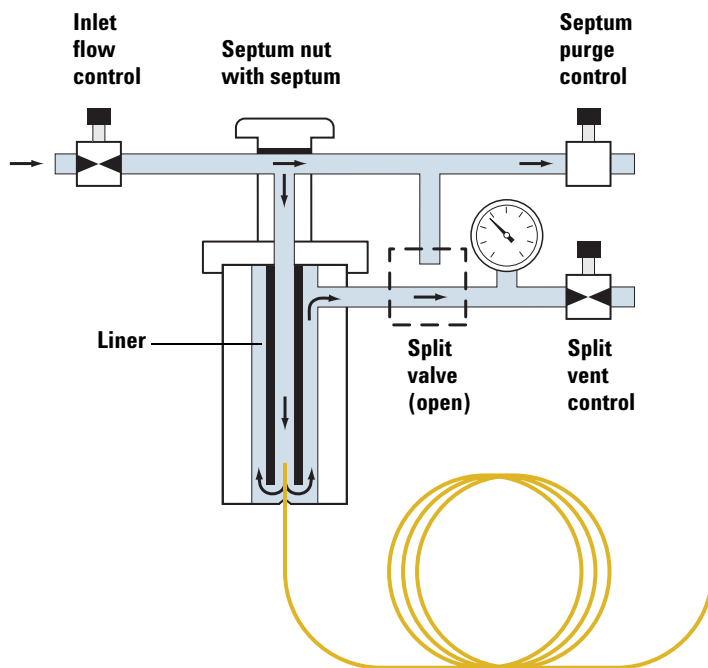

Figure 9 Split mode

The split valve is open and remains that way. The sample is injected into the liner, where it vaporizes. The vaporized sample divides between the column (high flow resistance) and the split vent (adjustable flow resistance).

Splitless mode

This mode is particularly well suited to low concentration samples. It traps the sample at the head of the column while venting residual solvent vapor in the inlet to waste.

Two steps are involved:

1 Sample injection

Close the split valve. The carrier flow divides between the septum purge and the column. The pressure at the head of the column, and therefore the flow through it, is set by the split vent control.

Inject the sample. The solvent, the major component, creates a saturated zone at the head of the column which traps the sample components.

Figure 10 shows the flows at injection in the *splitless* mode.

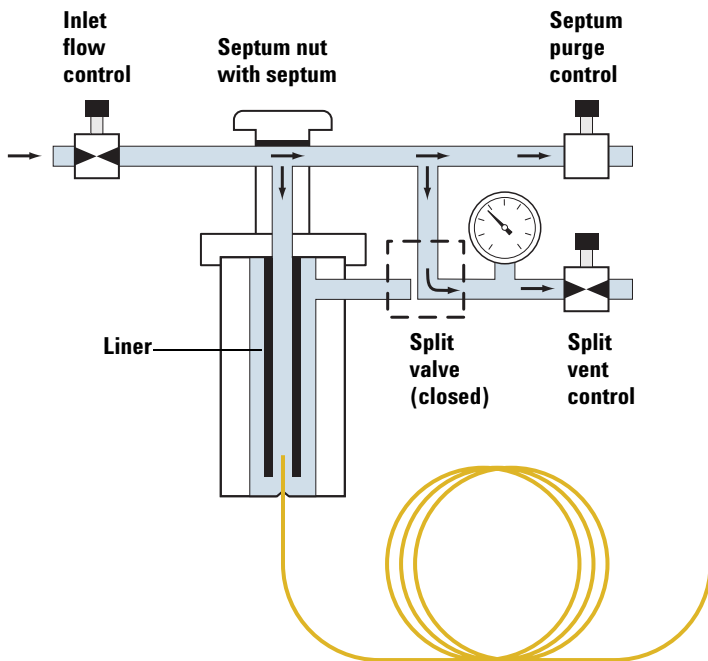

Figure 10 Splitless mode at injection

2 Inlet purge

After the sample has been trapped on the column, open the split valve. The residual vapor in the inlet, now mostly solvent, is swept out the vent.

The flows are now the same as in the split mode (Figure 9).

Raise the oven temperature to begin moving the components through the column.

This works well for components with boiling points higher than that of the solvent. The solvent peak will be large. The oven temperature profile is used to separate peaks of interest from the solvent.

Splitless mode steps

A successful splitless injection consists of these steps:

- 1 Vaporize the sample and solvent in a heated inlet.
- 2 Use a low column temperature to create a solvent-saturated zone at the head of the column.
- 3 Use this zone to trap and reconstitute the sample at the head of the column.
- 4 After all, or at least most, of the sample has transferred to the column, discard the remaining vapor in the inlet by opening the split vent valve.
- 5 Raise the oven temperature to release the solvent and then the sample from the head of the column.

Starting values

You must experiment to find the optimum parameters. [Table 1](#) contains some suggested starting values:

Table 1 Splitless mode inlet parameters

Parameter	Suggested starting value
Oven temperature	10°C below solvent boiling point
Oven initial time	≥ Split vent valve open time
Split vent valve open time	Liner volume x 2 / Column flow rate

Injection technique

Each peak begins as part of a region of vaporized sample surrounded by carrier gas. This width of this region broadens by diffusion while the peaks are in the column. No peak can be narrower than the initial region.

Since it is much easier to separate narrow peaks than broad ones, the width of the initial region must be minimized. The ideal injection is:

- 1 Fill the syringe and adjust the amount.
- 2 Push the needle through the injection port septum as far as it will go (port designers assume that you will do this).
- 3 Press the syringe plunger quickly.
- 4 Immediately withdraw the needle from the port.

The important parameter is speed. Any hesitation leads to increased region width.

A skilled operator can achieve 3 to 4% repeatability in sample size, provided he uses the technique described. Mechanical devices that limit the syringe plunger travel can improve on this.

Avoid techniques in which the sample is trapped between two air bubbles. This requires you to make two estimates and doubles the error in sample size.

Benefits of automatic injection

Automatic injectors provide a solution to the injection problem. They make highly reproducible injections. Because of this, they often permit a simpler calculation of peak amount (external instead of internal standard).

If part of an automatic sampler (equipped with a sample tray and connected to a data system), fully automated analyses become possible.

Valves

Gas sampling

A gas sampling valve consists of a sample loop and a means of shifting it in and out of the carrier gas stream.

A common form of the mechanism is shown in [Figure 11](#).

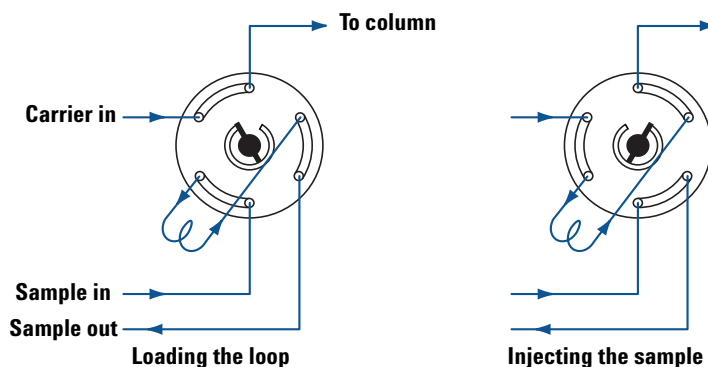

Figure 11 Gas sampling valve

Sample size is determined by the sample loop. This is replaceable, so that a single valve can provide a variety of highly reproducible sample injection sizes.

Liquid sampling

The principle is the same as for a gas sampling valve. Because a liquid sample requires a much smaller volume, the "loop" is part of the valve structure and is not replaceable.

To change sample size, you must replace the entire valve.

Inlet Temperature

Gas samples

For gas samples, the inlet does not have to vaporize anything so the inlet does not have to be heated.

However, most chromatographers prefer to heat the inlet to ensure that nothing condenses in it. A temperature of 100°C is often used.

Liquid samples

Liquid samples require a heated inlet. The temperature must be high enough to vaporize the sample but not so high that degradation occurs.

Hot enough Start with the solvent boiling point and examine the peaks. If they are all about the same shape (the sizes will differ), the inlet is probably hot enough. If the later peaks show excess broadening, raise the inlet temperature about 10°C to see if the shapes improve.

Too hot If you have more peaks than components and if they are poorly formed, suspect degradation problems.

Degradation in the inlet creates peaks whose size depends strongly on inlet temperature. To detect this, make a second analysis at a slightly lower temperature. Compare the peak sizes; any significant change could indicate degradation in the inlet.

2 Injecting Samples

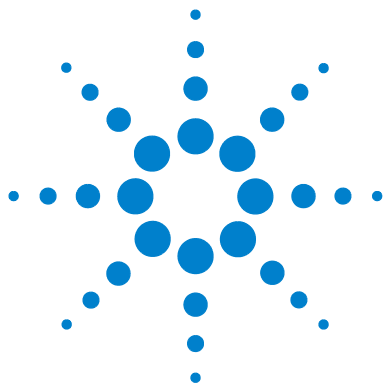

3 Separating Components

How a Column Separates Components	28
The basic principles of chromatography	29
Column Types	30
Capillary columns	30
Packed columns	30
Column tubing	31
Column Characteristics	32
Column efficiency	32
Gas control	33
Column resolution	34
Column selectivity	34
Capillary or Packed?	35
Column Temperature	36
Isothermal oven	36
Programmed oven	37

The separation of a mixture into individual components occurs in the column. Many columns are available to separate mixtures. The choice depends on the nature of the mixture and the kind of information desired. However, all columns function using the same basic mechanism.



How a Column Separates Components

This is a cross-section of a column containing a two-component injected sample (the colored dots). There is no packing or coating; the column is just an empty tube (Figure 12).



Figure 12 An uncoated column

If we look again a few seconds later, the appearance has changed (Figure 13).



Figure 13 A few seconds later

The “sample” has moved to the right because of the carrier gas flow. It has broadened because of the concentration difference between the sample and the pure carrier gas surrounding it.

The components are still mixed.

Now we add a thin coating of a high-boiling substance on the inside surface of the column and repeat the experiment (Figure 14).



Figure 14 A coated column

We can use any coating we wish. In this case, we select one that dissolves the blue-dot component but not the yellow-dot component.

The blue-dot component distributes itself between the coating and the gas. The yellow-dot component stays in the gas phase.

When we examine the column a few seconds later, we find this: [Figure 15](#).

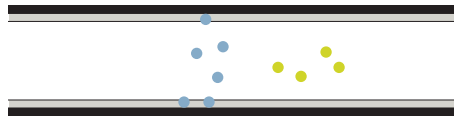

Figure 15 A few seconds later

The yellow-dot component is not attracted to the coating. It moves through the column at the speed of the carrier gas and will emerge first.

The blue-dot component divides its time between the stationary coating and the carrier gas. It travels through the column at a slower speed and will emerge later.

The sample has begun to separate into two peaks.

The basic principles of chromatography

- When a vaporized component is presented with a gas phase and a coating phase, it divides between the two phases according to its relative attraction to the two phases.
- The “attraction” can be solubility, volatility, polarity, specific chemical interaction, or any other property that differs from one component to another.
- If one phase is stationary (the coating) and the other is moving (the carrier gas), the component will travel at a speed less than that of the moving phase. How much less depends on the strength of the attraction.
- If different components have different “attractions”, they will separate in time.

Column Types

Capillary columns

A capillary column is an open tube with the stationary phase coated on its inside surface. There is no packing.

These columns range from about 0.1 to 0.5 mm inside diameter. A typical column length is 30 m. See [Figure 16](#).

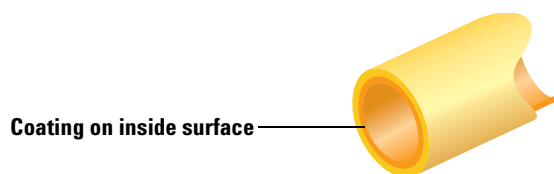

Figure 16 A capillary column

Capillary columns produce very narrow peaks. This allows the separation of very complex mixtures. For example, a typical automobile fuel yields between 400 and 500 peaks.

These columns, when made with fused silica tubing, are very inert. Difficult samples such as mercaptans, which tail severely on metal or glass columns, separate to the baseline on such columns.

Capillary columns require smaller samples than packed columns. A special inlet, see "[Split/Splitless port](#)" on page 19, allows a convenient-sized sample to be divided before it enters the column.

Packed columns

In a packed column, the stationary phase is coated on a finely-divided inert material to maximize its area and minimize its thickness. The coated material is then packed into a metal, glass, or plastic tube. See [Figure 17](#).

Most metal packed columns are either 1/8- or 1/4-inch outside diameter. Glass columns are generally 1/4-inch outside diameter, but the inside diameter varies to produce the equivalent of the two metal column sizes.

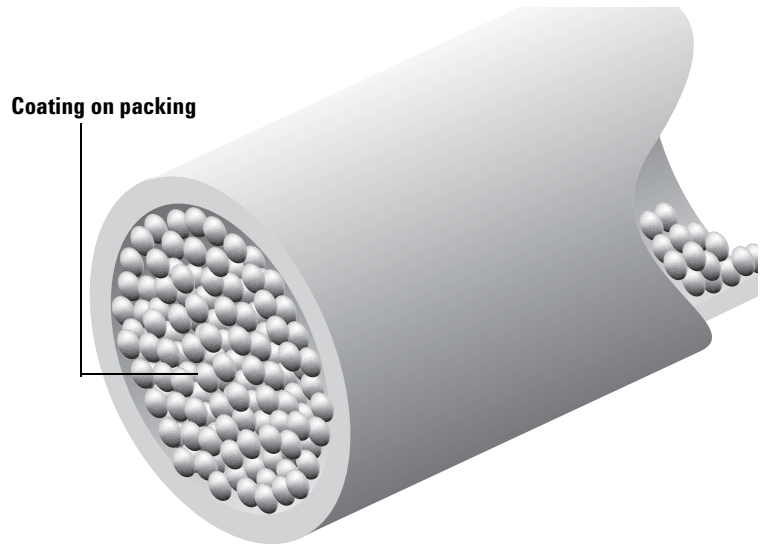

Figure 17 A packed column

Packed columns have high sample capacity, a necessity with older, less sensitive detectors. However, with modern high-sensitivity detectors, this advantage has vanished. Packed columns are still useful for gas samples, but capillary columns offer better resolution for most liquid samples.

Column tubing

Possible tubing materials include:

- Stainless steel—durable, but a relatively reactive surface may cause component loss or peak tailing.
- Glass—fragile, and usually requires treatment to deactivate the surface.
- Fused silica—used only in capillary columns, inert and robust, the preferred material for most uses.

Column Characteristics

The purpose of a column is to produce narrow, well-separated peaks from a multi-component sample. These two purposes are not entirely separate.

Column efficiency

A high-efficiency column produces narrow peaks. See [Figure 18](#).

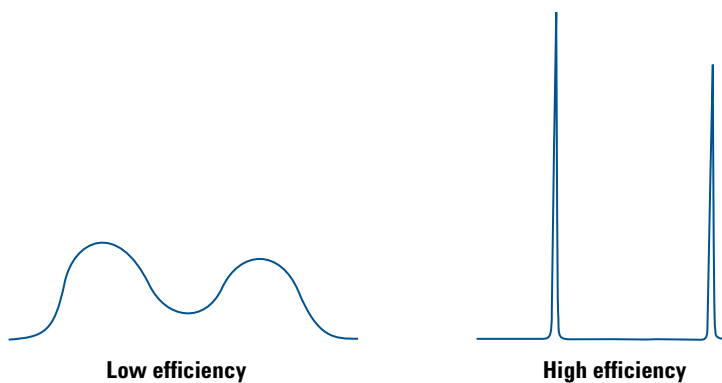

Figure 18 Column efficiency

Efficiency is determined by the column construction (small tubing diameter and thin stationary phase layer is best) and by the carrier gas flow rate.

See [Table 2](#) for recommended flow rates.

Table 2 Recommended carrier flow rates

Type	Diameter	Carrier flow rate, mL/min		
		Hydrogen	Helium	Nitrogen
Packed	1/8-inch od	30	30	20
Packed	1/4-inch od	60	60	50
Capillary	0.05 mm id	0.2 to 0.5	0.1 to 0.3	0.02 to 0.1
Capillary	0.1mm id	0.3 to 1.0	0.2 to 0.5	0.05 to 0.2
Capillary	0.2 mm id	0.7 to 1.7	0.5 to 1.2	0.2 to 0.5
Capillary	0.25 mm id	1.2 to 2.5	0.7 to 1.7	0.3 to 0.6
Capillary	0.32 mm id	2 to 4	1.2 to 2.5	0.4 to 1.0
Capillary	0.53 mm id	5 to 10	3 to 7	1.3 to 2.6

In each range, the lower value is close to optimum for the carrier gas and column combination. The higher value speeds the analysis without sacrificing very much efficiency.

Even higher flows, above the range given, can be used when separation is great or a shorter column is used. Flows below the range given increase analysis time and may cause an abrupt loss of efficiency.

Gas control

Flow in packed columns is usually controlled using mass flow controllers. Capillary columns, because of the very low flow rates, are usually pressure-controlled.

Some GCs provide electronic pneumatic control (EPC). Such instruments allow setting flows from a keyboard and reading them on a display.

Column resolution

A high-resolution column separates peaks down to the baseline. This is much easier if the peaks are narrow (the column is efficient).

A small change in flow rate can have an appreciable effect on resolution.

Combining the mathematical definitions of efficiency and resolution yields an important result:

Column resolution is proportional to the square root of column length.

This means that increasing column length is *not* an effective way to improve resolution. Doubling the column length doubles the analysis time (and the column cost) but only increases resolution by about 40%.

Column selectivity

This is a less clearly defined property of the stationary phase. Essentially, it is how well a phase differentiates between two compounds. Low selectivity—they elute together. High selectivity—the peaks separate.

Capillary or Packed?

Both have their places. Here are some of the considerations.

- Gas analyses are usually done using packed columns. They have the sample capacity to accommodate the rather large gas samples. Common packings for gas analysis include:
 - Molecular sieve—oxygen, nitrogen, helium, hydrogen, CO₂, CO, methane, etc.
 - Alumina—propane and up.
 - Porapaks—ethane, butane, CO₂, etc.

Some, but not all, of these can be used in capillary columns.

- Capillary columns have higher resolution than packed columns. Even with little selectivity, an adequate separation is often obtained.
- One capillary column can perform a variety of analyses that might require a collection of several packed columns to achieve.
- Useful stationary phases for both capillary and packed columns include:
 - Methyl silicones—non-polar to moderately polar
 - Phenyl methyl silicones (5 to 50% phenyl)—olefins, aromatics, to moderately polar
 - Carbowax (polyglycol)—acids, very polar
- The high resolution of capillary columns often permits trading resolution for time. Since resolution depends on the square root of length, an excellent capillary column can be cut into two very good capillary columns with only a minor loss in resolution. Analysis time is reduced to one-half!

Column Temperature

The stationary phase (coating) in the column has a preferred temperature range.

- The *minimum* temperature is usually a melting point. Below this, you are doing gas/solid chromatography; above it, you are performing gas/liquid chromatography. Results can be quite different.
- The *maximum* temperature is usually related to a boiling or degradation point.

Columns are mounted in a temperature-controlled oven because separations are highly temperature dependent.

The oven temperature can be isothermal or programmed. See [Figure 19](#).

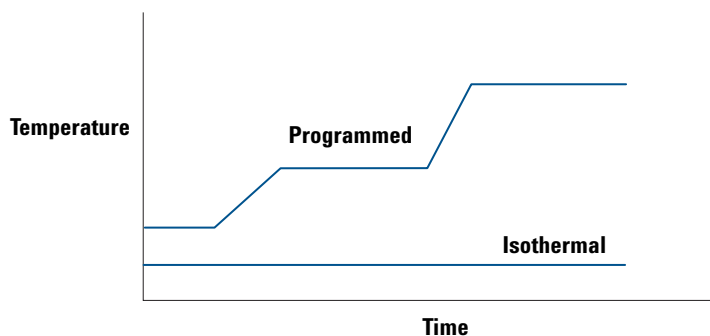

Figure 19 Oven temperature

Isothermal oven

This is the simplest way to run the oven. The oven remains at the same temperature throughout the analysis. It has *advantages*:

- The oven is always ready for a sample analysis.
- There is no recovery time between analyses.

And *disadvantages*:

- Samples with a wide range of component times take a long time to run.
- Because peaks broaden with time, later peaks may be difficult to detect or measure.

Programmed oven

The oven temperature changes, usually upward, during the analysis. The *advantages* are:

- Analysis time is reduced.
- Peak shapes are constant throughout the run, making detection and measurement easier.

The *disadvantages* are:

- Components are subjected to higher temperatures than with an isothermal oven. This could cause degradation of sensitive components.
- The oven must cool to the starting temperature between runs. This cancels part of the time gained.

3 Separating Components

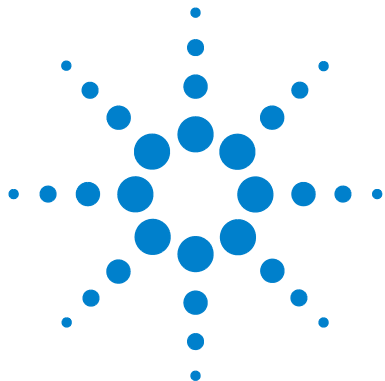

4 Detecting Components

Thermal Conductivity (TCD) 40

How it works 40

Flame Ionization (FID) 42

How it works 42

Electron Capture (ECD) 43

How it works 43

The three detectors described in this chapter do most of the GC work. They are augmented by others (see [Table 3](#)), mostly element-specific or mass-selective, which are not described in detail.

Table 3 Some other detectors

Name	Uses
Nitrogen-Phosphorus Detector (NPD)	Nitrogen- and phosphorus-containing compounds
Flame Photometric Detector (FPD)	Sulfur- and phosphorus-containing compounds
Atomic Emission Detector (AED)	Tunable for many elements
Mass Selective Detector (MSD)	Identify components from mass spectra; when combined with GC, the most powerful identification tool available



Thermal Conductivity (TCD)

All gases conduct heat, but hydrogen and helium are, by far, the best thermal conductors (see [Table 4](#)). When either of these is used as the carrier gas, anything else that may be present causes a decrease in the thermal conductivity of the gas stream.

This change can be measured and used to create a chromatogram.

Table 4 Thermal conductivities of gases relative to hexane

Gas	Relative thermal conductivity
Carbon tetrachloride	0.44
Benzene	0.88
Hexane	1.00
Argon	1.04
Methanol	1.10
Nitrogen	1.50
Helium	8.32
Hydrogen	10.68

Since the TCD operates on thermal conductivity differences, it is clear that hydrogen or helium are the preferred carriers.

How it works

When a voltage is applied to a filament, it heats up. The steady-state temperature depends on the applied voltage, the resistance of the filament, and the rate at which the filament loses heat to its surroundings.

If a filament is immersed in a gas stream, any change in the thermal conductivity of the gas causes a change in filament temperature. This changes the resistance of the filament.

Early TCD designs used four filaments connected as a Wheatstone bridge. The column effluent flowed over two opposite filaments; pure carrier gas (the reference) flowed over the other two. When a component appeared, the bridge became unbalanced.

A modern TCD design is shown in [Figure 20](#).

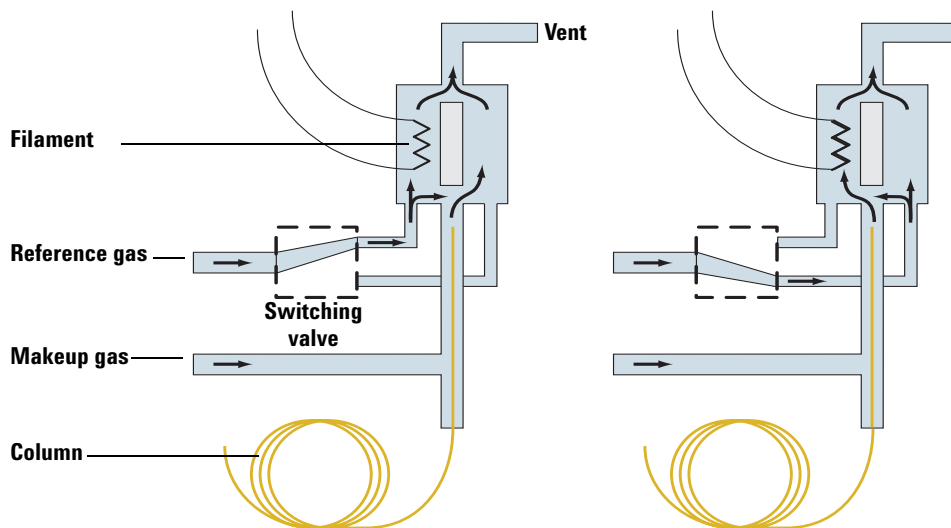

Figure 20 Thermal conductivity detector

This detector uses a single filament. A rapid switching valve causes it to sample the carrier effluent and a reference gas alternately. If the two gas streams are identical—no component present—the filament resistance does not change when the gases switch.

However, when a component enters the detector, the filament temperature drops when the column flow is switched in and then recovers when the reference gas is switched in. The electronics senses this change and adjusts the power to the filament to keep the temperature constant.

The power demand curve amplitude depends on the thermal conductivity difference between the column flow (when a component is present) and the reference gas.

Flame Ionization (FID)

An air/hydrogen flame creates very few ionized particles. However, if a carbon-containing material enters the flame, ion production increases.

How it works

The carrier gas from the column mixes with hydrogen and is burned in air. The FID uses two electrodes, one of which is often the jet where the flame burns, and a polarizing voltage to collect the ions from the flame.

When a component appears, the collected current rises. After amplification, the current creates the chromatogram.

The FID responds to anything that creates ions in a flame, which is essentially all organic compounds (there are a few exceptions).

A general FID design is shown in [Figure 21](#).

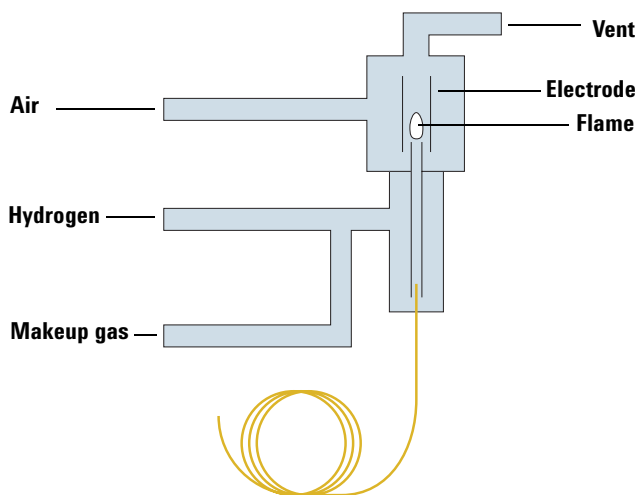

Figure 21 Flame ionization detector

Electron Capture (ECD)

The electron capture detector has found wide use in environmental work because of its very high sensitivity to halogen-containing components, which include most herbicides and pesticides.

How it works

A radioactive isotope, usually ^{63}Ni , in the detector cell emits beta particles. These collide with carrier gas to create showers of low-energy free electrons. Two electrodes and a polarizing voltage collect the electrons as a current.

Some molecules can capture low-energy electrons to form negative ions. When such a molecule enters the cell, some of the electrons are captured and the collected current decreases. After processing, this signal creates the chromatogram.

One form of the ECD is shown in [Figure 22](#).

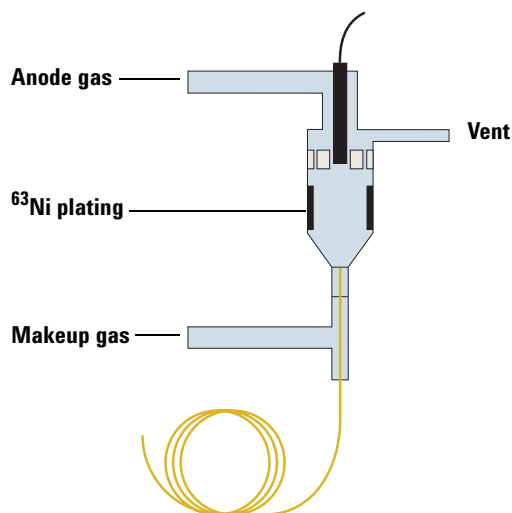

Figure 22 Electron capture detector

4 Detecting Components

The ECD is quite specific, responding strongly to anything that captures electrons and poorly to everything else. Some relative responses are listed in [Table 5](#).

Table 5 ECD sensitivities to selected compounds

Compound	Response relative to benzene = 1
Benzene	1
Toluene	3
Acetone	8
2,3-Butanedione	800,000
n-Butanol	17
Chlorobenzene	1,200
Bromobenzene	7,600
1-Chlorobutane	17
1-Bromobutane	5,000
1-Iodobutane	1,500,000
Chloroform	1,000,000
Carbon tetrachloride	6,600,000



5 Interpreting Chromatograms

Peak Measurements	47
Retention time	47
Peak size	47
Component Identity	49
Component Amount	50
Uncalibrated calculations	50
Area and height percent	50
Calibrated calculations	52
Normalization	54
External standard	55
Internal standard	56



5 Interpreting Chromatograms

The chromatograph produces a signal that varies with time. When plotted, it produces the familiar chromatogram (Figure 23).

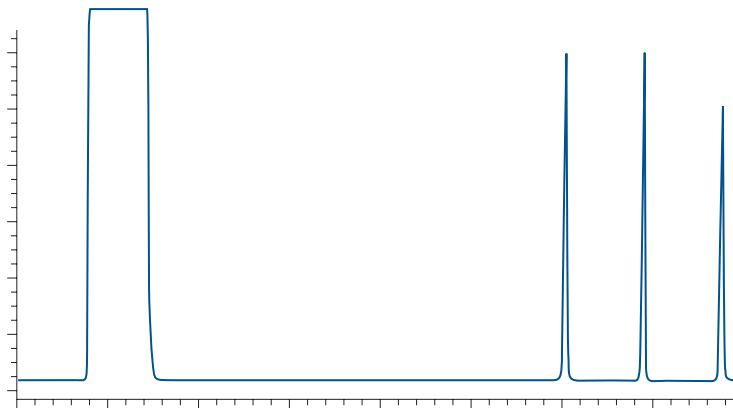

Figure 23 A typical chromatogram

The chromatogram can be converted into a list of peak times and sizes by either manual or electronic means.

Peak Measurements

Two basic measurements can be made on a peak:

- The time after injection when the peak is detected
- The size of the peak

Retention time

The *appearance time*, measured from injection to detection, is the sum of two parts:

- The *plumbing time*—how long it takes for the carrier gas to pass through the column. It is measured by injecting air or some other non-interacting substance.
- The *retention time*—the additional time caused by the component's interaction with the stationary phase in the column.

For most purposes, the plumbing time is ignored and the retention time is taken as the appearance time.

Peak size

Size can be measured either as peak area or peak height, both measured relative to a constructed baseline.

The baseline under the peak cannot be measured directly. It must be constructed from the baselines on either side of the peak.

This is simple with well-separated peaks. It is much more difficult when peaks are merged, on the trailing edge of a solvent peak, or otherwise less than ideal. For this reason, time spent improving the peak separation is time well spent.

Peak height

This is the simplest measurement, requiring only a ruler. It is the vertical distance from the top of the peak to the baseline.

Peak area

This is the area enclosed by the peak signal and the baseline under it. It is best measured by electronic means.

The two size measurements are shown in [Figure 24](#).

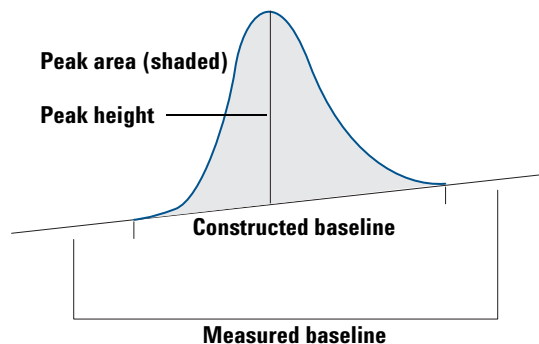

Figure 24 Measuring a peak

Integrators and data systems

Integrators excel at measuring peak areas or heights and peak retention times. They make the conversion of a curve (the chromatogram) into a table (of times and sizes) very simple and reproducible.

Data systems offer the same advantages and considerably more.

- A software integrator is more flexible than that in a hardware integrator.
- Data can be reprocessed using different integration and calculation parameters without re-injecting the sample.
- Systems perform the fundamental calculations described in this chapter, often with more sophisticated features.
- Systems produce user-designed formatted reports.
- Peak calibration becomes a very simple process.
- Both single- and multi-level calibrations are possible.
- Raw and processed data can be archived for later use.
- Systems process data from multiple GCs at the same time.

Component Identity

Because many compounds may elute at the same (or nearly same) retention time, gas chromatography by itself does not usually provide identification of a totally unknown sample.

However, it is a very powerful tool when the problem is more constrained. GC patterns can be compared to identify samples that have a high probability of being the same. For example, crude oil from a tanker can be compared to an oil slick on the ocean to determine if that tanker was responsible for the spill.

GC is quite useful for *eliminating* possibilities. If you know from previous experiment that iso-octane appears at 1.9 minutes, then the unknown peak at 1.5 minutes is definitely *not* iso-octane. But what is it?

Fortunately, you do not have to consider the entire universe of chemical compounds. Sample information limits the list of possibilities. For example, you would not expect to find streptomycin in a paint sample.

When a tentative peak identification has been made, it should be confirmed by repeating the analysis using a column that separates on a different basis. If a component has the right retention time on a boiling point column (methyl silicone) *and* on a polarity column (polyglycol), the identification is probably correct.

GC is especially useful in problems where the expected components are known and quantitation is required. GC will also usually detect the presence of unexpected components (as extra peaks).

Finally, GC can be connected to mass spectrometers or other selective detectors to provide additional data needed for positive identification of unknown components.

Component Amount

Uncalibrated calculations

A detector produces a signal while carrier gas is passing through it. If there is no component at the moment, the signal is the baseline. When a component appears, the signal increases.

The area between the projected baseline and the signal, while the component is passing through, is the peak area. The maximum vertical distance between the signal and the projected baseline is the peak height.

An integrator or data system handles the sometimes very difficult task of drawing the projected baseline, then measures the peak areas and heights. The results are the **Measured Responses (MR)**.

Area and height percent

Each peak is expressed as a percent of the total measured area or height in the run.

The detector is assumed to be equally sensitive to all components. [Equation 1](#) shows the calculation.

$$\text{Amount of peak } n = \left[\frac{\text{MR of peak } n}{\text{Sum of all MRs in the run}} \right] \times 100 \quad (1)$$

Advantages

- Fast setup, since no calibration is needed.
- Moderate sample size variation does not affect results.

Disadvantages

- All peaks must be detected.
- Any peaks not detected or not flushed from the column reduce the sum of MRs. This causes overestimation of all measured peaks.

Uncalibrated calculations do not correct for component sensitivity differences. This tends to overestimate the early peaks.

Common uses

- Generating a list of responses and retention times for building a calibration table.
- Analyses where the purpose is fast, reproducible results to be compared with preset limits.
- Useful in process monitoring, product release testing, etc.
- Not useful when absolute accuracy is important.

Calibrated calculations

If Area% and Height% are not adequate, the calibrated calculations use data from standard analyses to create individual peak calibrations.

The simplest calibration is the Response Factor, which is calculated by dividing the known amount of a component by the size of the peak it produces.

Graphically, it is the slope of a plot of component amount versus peak size, as shown in Figure 25.

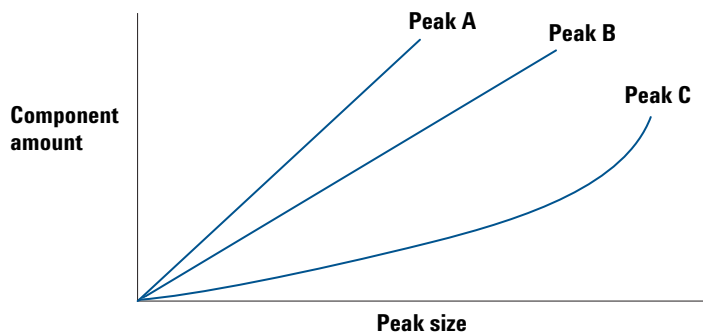

Figure 25 Response factors

Response Factors can be determined by analyzing a single standard mixture containing all of the components to be calibrated.

However, the Response Factor approach makes two important assumptions:

- The amount/size line passes through the origin.
- The amount/size line is straight.

For a trustworthy calibration, both assumptions must be demonstrated experimentally. If the line is really straight and really does pass through the origin, then the response factor is valid.

In [Figure 25](#), Response Factors can be used for peaks A and B, but not for peak C. The two forms of calibration correction are shown in [Equation 2](#) and [Equation 3](#).

For Peaks A and B:

$$\text{CR of peak} = \text{MR of peak} \times \text{Response Factor of peak} \quad (2)$$

For Peak C:

$$\text{CR of peak} = \langle \text{Response Curve amount} \rangle \text{ of MR of peak} \quad (3)$$

Peak C can only be corrected by using the entire calibration curve. This is laborious by hand, but is easily done using a data system.

Normalization

The normalization percent is similar to Area% and Height%, but uses Corrected Responses instead of Measured Responses, as shown in [Equation 4](#).

$$\text{Amount of peak } n = \left[\frac{\text{CR of peak } n}{\text{Sum of all CRs in the run}} \right] \times 100 \quad (4)$$

Advantages

- This calculation corrects for component sensitivity differences, which yields more accurate results for early peaks.
- Moderate sample size variation does not affect results.

Disadvantages

- The method must be calibrated.
- All peaks must be detected. Any peaks not detected or not flushed from the column will reduce the sum of CRs. This causes overestimation of all measured peaks.
- All peaks must be identified and calibrated to achieve the highest accuracy. Unknown (and therefore uncalibrated) peaks reduce the absolute accuracy of the calculation.

Common uses

- Provides very accurate results if there are no high-boilers to worry about.

External standard

The great advantage of external standard is that only the peaks of interest need to be calibrated. The calculation is very simple; see [Equation 5](#).

$$\text{Amount of peak } n = \text{CR of peak } n \quad (5)$$

Advantages

- Only the peaks of interest must be calibrated.
- Only the peaks of interest must be eluted and measured.
- Each calibrated peak is computed independently.

Disadvantages

- Peaks of interest must be calibrated.
- The calculation assumes that instrumental drift is negligible. Known check samples must be run regularly to confirm this.
- Constant sample size is essential, since this is an absolute (rather than relative) calculation. This is very difficult to achieve using manual injection. In practice, a gas or liquid sampling valve or an automatic liquid sampler is a necessity.

Common uses

Gas analyses using a sampling valve. As instrument stability improves, and with the help of automatic injection devices to ensure constant sample size, ESTD is taking over many analyses that formerly required ISTD.

Internal standard

Internal standard provides independent calculation of each calibrated peak. It also corrects for variation in sample size, instrument drift, and other factors.

ISTD is considered the most accurate chromatographic calculation, although ESTD with modern equipment is rapidly improving.

The basic calculation is shown in [Equation 6](#).

$$\text{Amount of peak n} = \left[\frac{\text{CR of peak n}}{\text{CR of ISTD peak}} \right] \times \text{Amount of ISTD peak} \quad (6)$$

The quantity **Amount of ISTD peak** is a known amount of the internal standard compound that is added to each sample before analysis.

This is generally considered to be the most accurate of the calculations.

Advantages

- Only the peaks of interest must be calibrated.
- Only the peaks of interest must be eluted and measured.
- Each calibrated peak is computed independently.
- Minor variation in sample injection size does not affect results.
- Minor instrumental drift does not affect results.

Disadvantages

- Peaks of interest must be calibrated.
- A known amount of an internal standard substance must be added to every sample.

Common uses

Liquid sample analysis where high accuracy is required.

Note

The term internal standard has come to have two slightly different meanings:

- 1** ISTD was originally developed to compensate for differences in manual sample injection size. To do this, the internal standard was added to the ready-to-inject sample after any sample workup (distilling, extracting, etc.) was completed. The main requirements for the internal standard were that it not be present in the original sample and that it produce a well-defined peak that is well resolved from the sample peaks. It did not have to be chemically similar to the sample components.
- 2** In many biochemical and related applications, the internal standard is added to the raw sample before sample workup. In this case, it must be chemically similar to the sample so that it will be affected by the workup steps in much the same way. Now the internal standard is being used to correct for two different things: variation in percent recovery during workup and sample size differences in the injection. This is not possible with a single standard. By precisely controlling the sample workup process and experimentally confirming that percent recovery is highly reproducible, that source of error can be reduced to an acceptable level.

5 Interpreting Chromatograms



Agilent Technologies

© Agilent Technologies, Inc.

Printed in USA, May 2002



G1176-90000